



Workbook

6th Edition

The official guide to
obtaining RMDL &
PWCL qualifications

Activities Completion Recognition Form

To be filled in upon completion of relevant activities within this Workbook (Chapters 1-6 for RMDL and Chapter 7 for PWCL).

Candidate name: _____

Address: _____

Postcode: _____

Phone: _____ Date of birth: ____/____/____

Course date: ____/____/____ Course place: _____

Statement of original work

I declare that I personally completed all submitted activities from the BoatSafe Workbook.

Candidate signature: _____

Assessor to complete

BoatSafe Training Organisation name: _____

Assessor name: _____

Course: Recreational Marine Driver Licence (RMDL)

Personal Water Craft Licence (PWCL)

Recognition of Prior Learning (RPL)

Workbook marked on: ____/____/____

Workbook completed to a satisfactory standard: Result Competent Not yet competent Not Completed

Comments: _____

Overall assessment: (theory, practical, Workbook): Competent Not yet competent

Assessors signature: _____ Date: ____/____/____

Assessors note:

Please detach this page from BoatSafe Workbook and retain with candidates' assessment files.

The workbook is to be returned to candidate. Information required on this form is to be completed in full.

To the candidate

How to get the most out of this workbook

You may be preparing to undertake a BoatSafe training course to obtain either a recreational marine driver licence (RMDL) or a personal watercraft licence (PWCL).

This workbook is designed to be used in conjunction with a BoatSafe course. The questions posed in the activities can be drawn from the subject matter provided in the workbook text.

6th edition published February 2017



© The State of Queensland
(Department of Transport and Main Roads) 2017
To view a copy of this licence visit:
<http://creativecommons.org/licences/by-nc-nd/2.5/au>

All enquiries to:

The Department of Transport and Main Roads
Email: boatsafe@tmr.qld.gov.au

No warranty, expressed or implied is given as to the material contained within this guide. The best efforts have been made to ensure the accuracy of the material contained within.

After reading the relevant sections of the text, answer each question in the corresponding activity sections of the workbook.

- Write clearly and legibly
- Explain answers using your own words
- Answer all the questions
- If you are unsure of an answer, speak with your BoatSafe course instructor and complete the question prior to your practical assessment
- If you make an error, cross it out and write the correct answer above the error

Ideally, the workbook should be completed prior to your attendance at the practical component of a BoatSafe course, and it is highly recommended that all participants do so in preparation for a BoatSafe course.

In some instances, completion of the activity questions in the BoatSafe Workbook is a prerequisite for enrolment in the BoatSafe course. Ask your BoatSafe Training Organisation if this applies to you.

Bring your workbook to the practical component of the course for discussion, review and feedback. The workbook remains with you as a resource for future study. The assessor will tear out the BoatSafe Workbook Activities Assessment Cover Sheet and retain it as a record of your assessment.



Introduction

The BoatSafe Workbook is a publication for all boat operators. It is essential reading for people wanting to learn how to drive a boat or ride a PWC, and an excellent refresher for those at all levels of experience on the water.

The workbook covers all aspects of boating from preparation and pre-departure checks to safely moving around on the water and implementing emergency procedures. The content complements Queensland's recreational licensing scheme, BoatSafe, with a number of activities at the end of each section.

Licensing requirements

To ensure all people operating boats in Queensland have a level of competence, a recreational marine driver licence (RMDL) is required. All people operating registrable boats powered by an engine of more than 4.5 kW require a RMDL. A licence is obtained through successfully completing a competency-based BoatSafe course.

BoatSafe courses are conducted by BoatSafe Training Organisations (BTO) accredited by the Department of Transport and Main Roads. BTOs conduct courses designed around a set of core boat operator competencies. This means all licence applicants, no matter where they are assessed, will be assessed in a consistent way against the same criteria.

To be eligible for a RMDL, applicants must be aged 16 years or older with appropriate identification. Of course, younger people are encouraged to complete BoatSafe courses; however, they will be unable to obtain the qualification until they turn 16 years old.

Under the BoatSafe scheme, BTOs can consider alternative boating qualifications held by applicants under a recognition of prior learning (RPL) process. In this case applicants may be exempted from some or all of the training required to qualify for their licence.

Talk with your BTO about your eligibility for recognition of prior learning and/or remote learning and flexible delivery mode courses.

Personal watercraft licence

Compared with other boat types, personal watercraft (PWC) are involved in a high percentage of marine incidents given the numbers registered.

With this in mind, all PWC operators must hold a personal watercraft licence (PWCL). Successful completion of the RMDL course, or possession of a RMDL or valid, equivalent marine licence is a prerequisite for PWCL training, assessment and issue.

Current marine licences include current RMDL, Speed Boat Driver Licences, commercial marine licences and equivalent licences issued in other states. Section 7 of this workbook is an ideal starting point for PWCL candidates.

Your marine licence

After successfully completing a BoatSafe course you will receive a statement of competency. The statement of competency is not your licence. It must be taken to a Department of Transport and Main Roads customer service centre where the qualification is added to the Queensland driver's licence database. This must be done within six months of completing the course otherwise you will have to present to a BTO for reassessment.

Queensland RMDLs and PWCLs are virtual, meaning you are not required to carry evidence of your licence. However, all new and replacement Queensland driver's licences issued since July 2006 have included a marine licence indicator.

Holders of RMDLs and PWCLs can also request a verification certificate through the Maritime Safety Queensland website – under the 'Services online' heading. A small fee for this service will be charged (payable by credit card).

Keep up to date

Gaining a marine licence should not be considered the end of your learning. All ship owners (owners of boats or PWC) should be vigilant and keep up to date with the latest boating information. Licence holders should be aware of changes in safety regulations, changes to navigation marks and channels and always keep your boat in peak condition.

The Maritime Safety Queensland website <www.msq.qld.gov.au> will keep you up to date with many of these changes.

Table of contents

1.0	Preparation	
1.1	Glossary	8
1.2	Language	11
1.3	Hull	11
1.4	Construction material	12
1.5	Propulsion	13
1.6	Batteries	14
1.7	Buoyancy	14
1.8	Seaworthiness	15
1.9	Registration	16
1.10	Capacity specification	16
1.11	General safety obligation	17
2.0	Pre-departure checks	
2.1	Trip plan	19
2.2	Boat check	19
2.3	Routine maintenance	21
2.4	Tools and spares	23
2.5	Fuel	23
2.6	Safety equipment table	25
2.7	Water limits	26
2.8	Safety equipment	32
2.9	Weather	38
2.10	Tides	41
3.0	Manoeuvring	
3.1	Influencing factors	44
3.2	Launching and retrieving	46
3.3	Berthing and unberthing	47
3.4	Attaching to a mooring	48
3.5	To anchor	48
4.0	On the water	
4.1	International code of signals	52
4.2	IALA buoyage system	54
4.3	Rules of the road	58
4.4	Sound signals	59
4.5	Navigation lights	59
4.6	Navigating	62
4.7	Local rules	63
4.8	Bar crossing	63
4.9	Navigating near shipping channels	64
4.10	Waterskiing rules	65
4.11	Alcohol and drug obligations	66
4.12	Enforcement officers	66
4.13	Incident reporting	67
4.14	Pollution	68
4.15	Marine animals and habitats	70
5.0	Emergency response	
5.1	Engine failure	73
5.2	Abandoning the boat	73
5.3	Fire	73
5.4	Capsize	75
5.5	Person overboard	75
5.6	Grounding	75
5.7	Personal survival	76
5.8	First aid	76
6.0	Emergency communications	
6.1	Distress signals	81
6.2	Marine radio	81
6.3	Mobile phones	83
7.0	Personal watercraft	
7.1	Licensing	85
7.2	Preparation	85
7.3	Pre-departure checks	86
7.4	Manoeuvring	87
7.5	On the water	91
8.0	Where to find additional information	
8.1	Maritime Safety Queensland office locations	95
8.2	Further reading	95

1.1 Glossary

a	
abeam	at right angles to the fore and aft line of the boat, but not on the boat.
adrift	loose, not on moorings or towline.
aft	the stern of the boat.
aid to navigation	a device designed to be used for navigation for the guidance of mariners.
amidships	the centre of the boat.
astern	behind the boat, opposite of ahead.
b	
bar	shallow area (which may be dangerous) formed by sand, mud, gravel or shingle near the mouth of a river or at the approach to a harbour.
beam	the greatest width of the boat.
Beaufort Scale	a scale used in reference to measurement of wind force.
bilge	the interior of the hull below the floor boards.
bow	the forward part of a boat.
bridge	the location from which a ship is steered and its speed controlled; 'control station' is really a more appropriate term for small boat.
bulkhead	a vertical partition separating compartments.
buoy	an anchored float used for marking a position on the water or a hazard or a shoal and for mooring.
buoyancy	the ability to float.
c	
capsize	to overturn a boat.
cast off	to let go.
chart datum	reference water level for soundings and drying heights on a chart and for tides.
chine	the intersection of the bottom and sides of a flat or v-bottomed boat.
current	the horizontal movement of water.
d	
displacement hull	a type of hull that ploughs through the water, displacing a weight of water equal to its own weight, even when more power is added.
draft	the depth of the boat below the waterline.
drogue	a cone-shaped parachute device to aid control by slowing ships down in heavy weather.
e	
ebb tide	a receding tidal flow.
EPIRB	emergency position indicating radio beacon.
f	
fairway	a navigable channel.
fathom	six feet.
flare	(a) the outward curve of a boat's sides near the bow; (b) a distress signal.
flood tide	an incoming tidal flow.
following sea	an overtaking sea travelling in the same direction of the boat.

fore-and-aft	in a line parallel to the keel.
fouled	any piece of equipment that is jammed or entangled, or dirtied.
freeboard	the minimum vertical distance from the surface of the water to the gunwale.
g	
give-way vessel	a term used to describe the ship which must yield in meeting, crossing, or overtaking situations.
ground tackle	a collective term for the anchor and its associated gear.
gunwale	the upper edge of a boat's sides.
h	
heading	the direction in which a ship's bow points at any given time.
headway	the forward motion of a boat; opposite of sternway.
heave-to	settling the boat into the wind with minimal headway.
helm	the wheel or tiller controlling the rudder.
hold	a compartment below deck in a large ship, used solely for carrying cargo.
hull	the main body of a ship.
hypothermia	a condition in which a person's body temperature is dangerously low due to exposure to severe cold.
i	
inboard	(a) more toward the centre of a ship; (b) inside; (c) a motor fitted inside a boat.
isobar	line on a weather map joining places of equal air pressure.
k	
keel	(a) the centreline of a boat running fore and aft; (b) the backbone of a ship.
knot	a measure of speed equal to one nautical mile (1852 m) per hour.
knot	a fastening made by interweaving rope to form a stopper, to enclose or bind an object, to form a loop or a noose, to tie a small rope to an object, or to tie the ends of two small ropes together.
l	
latitude	the distance north or south of the equator measured and expressed in degrees.
leads	marks which in line indicate the centre of a navigable channel.
lee	the side sheltered from the wind.
lee shore	the shore onto which the wind blows but downwind of a boat.
leeward	the direction away from the wind; opposite of windward.
leeway	the sideways movement of the boat caused by wind.
log	(a) a record of courses or operation; (b) a device to measure speed.
longitude	the distance in degrees east or west of the meridian at Greenwich, England.
m	
making way	ship under way and moving through the water.
midship	approximately in the location equally distant from the bow and stern.
mooring	an arrangement for securing a boat to a mooring buoy or a pier.
n	
nautical mile	one minute of latitude—approximately 1852 m.
navigation rules	the regulations governing the movement of ships in relation to each other, generally called steering and sailing rules, or rules of the road.
neap tide	tide when there is the smallest rise and fall (range) of water levels.
p	
piloting	navigation by use of visible references, the depth of the water and so forth.
planing	a boat is said to be planing when it is essentially moving over the top of the water rather than through the water.
planing hull	a type of hull shaped to glide easily across the water at high speed.

port	(a) the left side of a boat looking forward; (b) a harbour.
PWC	personal watercraft.
q	
quarter	the sides of a boat aft of amidships.
r	
rode	the anchor line and/or chain.
rudder	a vertical plate or board for steering a boat.
running lights	lights required to be shown on boats under way between sunset and sunrise.
s	
satellite navigation	a form of position finding using radio transmissions from satellites with sophisticated on-board automatic equipment.
scope	technically, the ratio of length of anchor rode in use to the vertical distance from the bow of the ship to the bottom of the water.
screw	a boat's propeller.
scuppers	drain holes on deck, in the toe rail, or in bulwarks or (with drain pipes) in the deck itself.
sea room	a safe distance from the shore or other hazards.
seaworthy	a boat or a boat's gear able to meet the usual sea conditions.
set	direction toward which the current is flowing.
sounding	a measurement of the depth of water.
spring tide	tide when there is the largest rise and fall (range) of water levels.
squall	a sudden, violent wind often accompanied by rain.
stand-on vessel	that boat which has right-of-way during a meeting, crossing, or overtaking situation.
starboard	the right side of a boat when looking forward.
stern	the after part of the boat.
stow	to put an item in its proper place.
t	
tidal range	the difference in height of water between high and low tides.
tiller	a bar or handle for turning a boat's rudder or an outboard motor.
topsides	the sides of a ship between the waterline and the deck; sometimes referring to onto or above the deck.
transom	the stern cross-section of a square—sterned boat.
trim	fore and aft balance of a boat.
u	
underway	ship not moored, at anchor, or aground.
w	
wake (wash)	moving waves, track or path that a boat leaves behind it, when moving across the waters.
waterline	a line painted on a hull which shows the point to which a boat sinks when it is properly trimmed.
windward	toward the direction from which the wind is coming.
y	
yaw	to swing or steer off course, as when running with a quartering sea.

Material obtained from www.marine waypoints.com

1.2 The language of boating

'Jargon' or specialised language has been developed over the years to refer to specific aspects of boating and provide clear and concise communication. You don't need to know all of the terminology, but a working knowledge will prove useful.

Basic parts of a boat

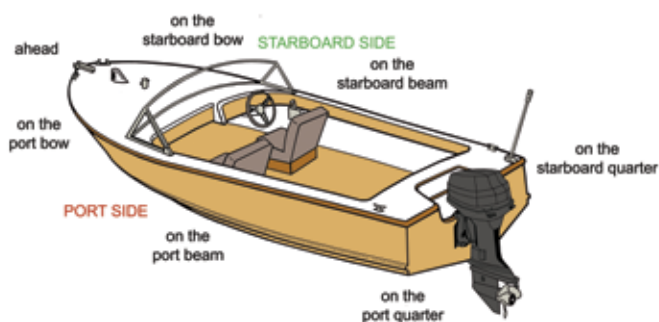
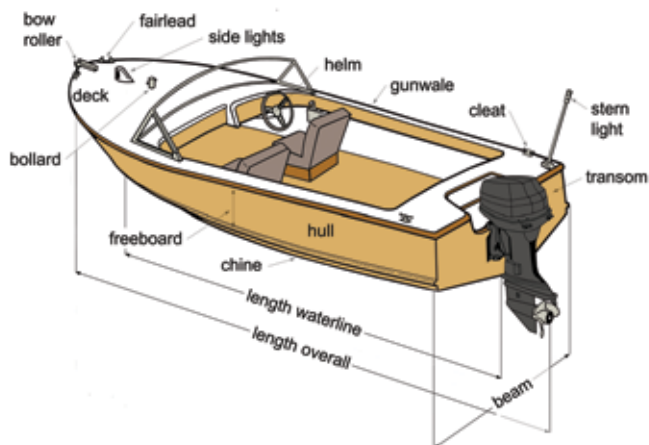

1.3 The hull

The design of a boat's hull determines how it will handle, how fast it will go and how steady it will be at sea. It will also influence load-carrying capability, fuel economy and engine requirements. Above all else, it will determine how safe the boat will be in varying conditions.

The two basic hull shapes are:

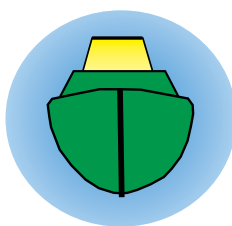

round bilge

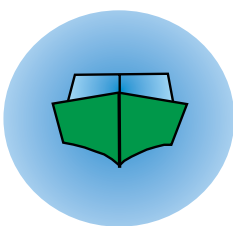

hard chine

All boats displace some water when floating. The amount of water displaced by the boat is equal to the weight of the boat (including all items placed in it). The round bilge boat above would displace much more water than the light, shallow hard chine hull and sink more.

Displacement hull

These boats move through, not on, the water. They have good directional stability, have good stability in loading, and generally handle heavy weather well. Most displacement boats have inboard or inboard/outboard motors, and are usually kept on moorings. Characteristics include:

- deep, full-bodied hull
- good load-carrying capacity
- easily moved with modest power
- easy, comfortable motion.

Displacement speed can be reached with quite small engine power. Any increase in speed beyond this would require a massive increase in power and fuel consumption.

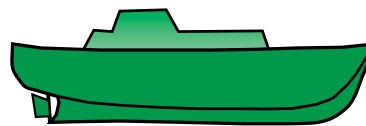

Planing hull

The powerful motor of a planing boat lifts the hull up and out of the displacement mode, well ahead of the bow wave, with only a small part of the flatter after-section of the hull in contact with the water. Characteristics include:

- light boats with less load-carrying capacity
- sufficient power
- hull shaped to provide lift
- most are hard-chined with a relatively flat section to the hull
- capable of much higher speeds than displacement boats.

All planing hulls are designed to go fast in smooth water. They can also plane in rough conditions, but speed may have to be reduced to below planing speed. The planing hull is also less efficient at slow speed, so care must be taken to maintain stability. This also means careful loading is critical.

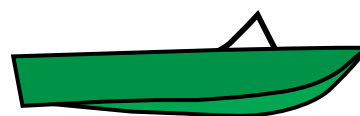

Off the plane



On the plane

Semi-displacement hull

This hull shape has a hard chine but a deep V forward reducing to a shallow V or nearly flat section aft. These boats require very large engines to achieve planing.

The deep V-section hulls cut through the water, giving a softer ride than boats with shallower hulls. They are primarily built for offshore performance as they ride well in a seaway and track well through waves. They require larger motors with corresponding increases in fuel costs.

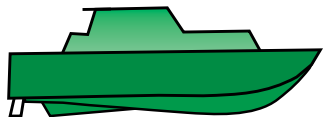

Inflatables

Full inflatable or semi-rigid inflatable boats have great stability and give a soft though wet ride at speed, although in choppy water there is the risk of occupants being bounced out by an unexpected wave.

Inflatables are widely used in surf rescue work because of their low freeboard, soft sides and ease of launching. They are also popular as divers' workboats or yacht tenders.



They have their drawbacks—they have poor directional control and are susceptible to punctures as well as deterioration through ultra-violet (UV) radiation.

The development of rigid inflatable boats (RIBs) combining the benefits of the basic inflatable with those of a rigid hull has largely overcome these drawbacks.

Catamaran hull

The catamaran hull maintains the ride of a deep V hull and provides greater stability by spreading buoyancy over separated hulls. A cushion of air between the hulls at speed softens the ride but pounding of the bridge decking as the seas get up can negate this. The catamaran tends to turn flat, increasing the need for persons to hang on during turning.



Cathedral (tri) hull

This hull combines the advantages of the catamaran and deep V hulls. It is relatively stable, has a good ride and excellent turning. Being more complex to build, it tends to be a little more expensive.

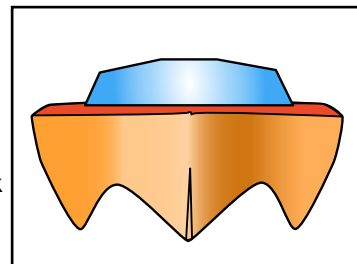

1.4 Construction material

Boats are made from a variety of construction materials; each has its advantages and drawbacks. Consider factors such as weight, robustness, maintenance and appearance.

Glass-reinforced plastic (fibreglass)

Fibreglass hulls are strong and impact resistant. They need little maintenance if the surface gel coat is not damaged. If a fibreglass boat is kept permanently on a mooring, water can penetrate the layers of mat through chipped or rubbed patches, and an expensive case of osmosis can result. UV degradation can be a problem and the material can also be quickly abraded if dinghies are dragged across sandy beaches. Small patching jobs in fibreglass are straightforward, but major repairs are best left to professionals.

Aluminium

Aluminium is excellent boat-building material, especially for dinghies and workboats. 'Tinnies' outnumber all other small boats as they are versatile, light, fast, easy to handle, hard to damage even on rough landings, and need minimal maintenance. On the downside, they tend to be cold and noisy at sea. Electrolysis corrosion can be a problem if the boat is left in the water. Steel chain and anchors should not be left in permanent contact with the hull.



Rigid inflatables

Inflatable boats are now constructed of UV resistant PVC and are widely used as tenders or by rescue groups. They are often referred to as Inflatable Rubber Boats (IRBs).

Rigid hull inflatables have a fibreglass or aluminium hull with an inflatable pontoon attached.

As small tenders, they have the advantage of being easily stowed aboard a larger boat, inflated or deflated. Inflatable dinghies are stable and can carry surprisingly big loads, although UV can break down the material and they can be easily chafed or cut. Care is needed when loading, beaching or coming alongside.

Steel

Steel is a relatively cheap and very strong method of building large hulls. Regular attention to paintwork is important to avoid corrosion. Corrosion by electrolysis can also be a major problem—cathodic protection should be built-in, and sacrificial zinc anodes used to capture stray electric currents that can quickly corrode metal in constant contact with salt water.

Ferro-cement

Steel-reinforced concrete is a cheap and effective method of building large hulls, although the plastering and curing process must be done with great care. It is strong and fire-safe, though harder to repair than other materials. Possible electrolysis of steelwork is a downside of this material, as is the difficulty in insuring boats of this construction.

Timber

Wood is a traditional and well proven boat-building material. Wooden hulls are quieter and warmer than hulls of other materials, although they are susceptible to rot and attack by marine pests such as borers and worms. The finishing paintwork is critical—whether built with solid timber planking or marine ply sheeting, wooden boats must be properly protected.

1.5 Propulsion

Each boat, depending on its design and intended use, will require different types of propulsion.

Most boats use outboard engines and are less than 6 m in length. Larger keel boats and motor cruisers will have inboards or stern drive (inboard/outboard) motors.

Outboards

Outboard motors are ideal on smaller boats. They are light and powerful and modern outboards are extremely quiet.

The outboard provides a completely self-contained propulsion system from engine to transmission to shaft and propeller. They are most often mounted directly on the transom of the boat. However, you may find boat designs incorporating a motor well or bracket on which the motor mounts. The entire motor swivels about to provide easy steering as the turning propeller pushes the stern.

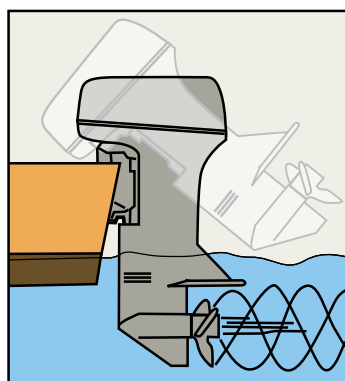

Outboards come in a large range of sizes, numbers of cylinders and horsepower and can use different fuel types:

- small electric trolling motors
- petrol and oil mixture two-cycle engines
- petrol-only four-cycle engines
- diesel powered outboards
- fuel and oil injected two-cycle engines.

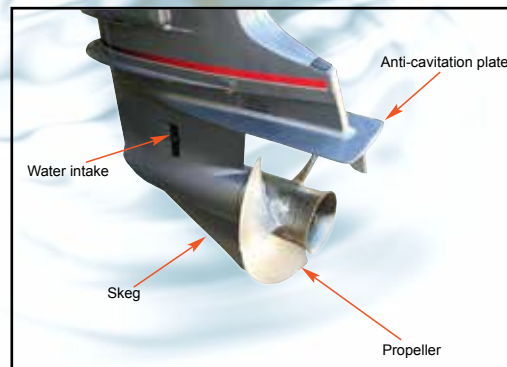
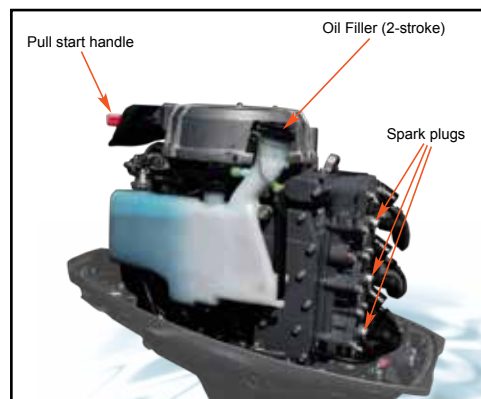

Outboards like to be used regularly—long periods sitting idle aren't good for them. If stored outside, use a cover and if left in the water for long periods of time, raise the leg of the motor as weed and coral growth can choke the water intake surprisingly quickly.

Above about 25 hp, outboards should be steered by wheel rather than tiller—the powerful torque of bigger motors makes tiller control dangerous.

A kill switch is an essential safety item—clipped to your wrist, jacket or belt, it cuts the motor if you are thrown away from the helm.



Stern drives (inboard/outboard)

Stern drives are generally heavier than outboards. They consist of an engine mounted inboard and a drive unit attached low on the transom.

The stern drive steers as for an outboard and can generally be tilted up and down to provide boat trim while under way.

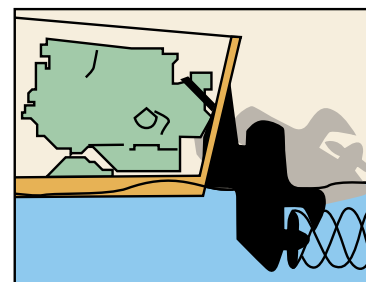

Stern drive motors come in petrol and diesel models and larger ones generally have more power than outboards. Because the main power supply is similar to a vehicle engine, easily accessible and more powerful, stern drives are often favoured over outboards on larger boats.

Inboards

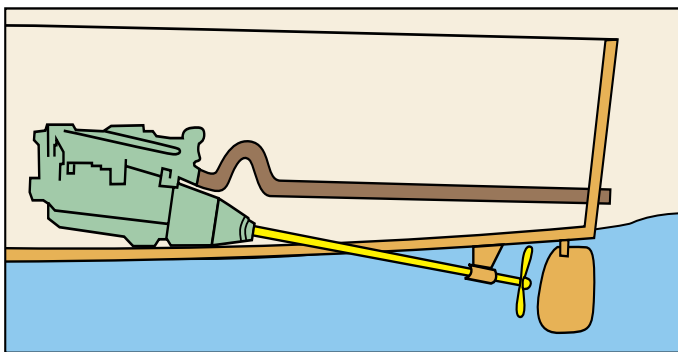

On larger displacement boats, shaft-driven propellers and steering by rudder from tiller or wheel are the norm.

The engine, similar to the inboard/outboard, is mounted inside the boat toward the centre to give good weight distribution. Inboard engines may be marinised vehicle motors or purpose-built marine diesels. There are petrol inboard engines but by and large they are avoided. Compared to a diesel engine, they have a much higher risk of fire and explosion, are more affected by water in the electrics (rely on electric spark ignition rather than a diesel's compression ignition) and produce a more toxic gas exhaust.

Jet drives

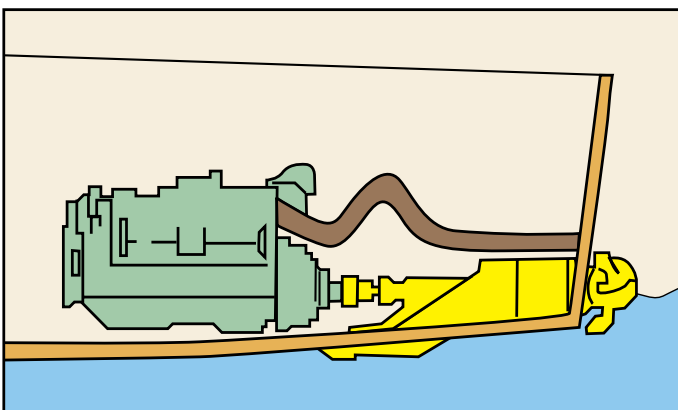

These propulsion systems have the advantage of having no propeller to cause potential danger to people in the water and marine life. They are usually inboard engines that take in water that flows through a pump powered by an impeller. The water is then discharged at high pressure through a nozzle that propels the boat forward. The nozzle swivels to provide steering to the boat. Most personal watercraft use jet drives.

1.6 Batteries

On boats, batteries run all electrical systems like the engine starting, radios, lighting and navigational instruments.

The number of batteries on board depends on the power needed to operate the boat.

If you require two or more batteries in order to increase the amperage capacity, it is recommended you seek advice from a marine electrician.

Batteries should be removed periodically from a confined space for recharging with a portable charger.



1.7 Buoyancy

Many smaller boats are built with buoyancy and are said to have either basic or level flotation (the ABP should indicate which one the boat is fitted with). The amount of flotation and where it is placed determine how the boat responds when swamped with water.

Inbuilt buoyancy is also possible in larger fibreglass boats and in most cases it must be requested before manufacture.

The benefits of buoyancy are:

- the boat will stay afloat when capsized or swamped
- it can provide the opportunity to bail water out of the boat
- passengers can stay with the boat until help arrives
- the boat provides shelter and gives more time to activate emergency procedures.

Boats without inbuilt buoyancy can sink within seconds—so quickly that a swamping can be life-threatening.

In smaller boats, generally speaking, flotation is having enough foam to compensate for the weight of the motor and to provide balance at the bow, under the seats or at the sides above the waterline.

There are different levels of flotation when a boat is filled with water:

Not enough or no flotation

The craft sinks quickly.

Basic flotation



This means the boat will float in some form if swamped. If the boat has capsized, it will remain afloat for you to possibly cling to the upturned hull.

Level flotation



This means that the boat will continue to float in a level position if swamped and will be prevented from capsizing in calm water. The buoyancy will allow you to remain in the boat and bail the vessel to remove the water. Additional flotation will prevent a boat from capsizing.

Note that all boats manufactured after July 1, 2006 are required to have some form of flotation, either level or basic.

Australian Builders Plate

All new recreational craft manufactured or imported into Queensland since September 2006 are required to show an Australian Builders Plate (ABP). The plate provides essential safety information about the use and limitations of the boat including the maximum number of people allowed on board, engine rating and weight and buoyancy performance (see below for full details shown on the Australian Builders Plate).

The presence of the Australian Builders Plate enables informed decisions on purchase and encourages appropriate use of boats.

The plate is to be permanently fixed and readily visible to the boat's operator in the cockpit or near the steering position.

1.8 Seaworthiness

It is the owner/master's responsibility to ensure the boat is in a seaworthy condition while being operated and adequate measures are taken to ensure the safety of the occupants. This is part of the general safety obligation.

Seaworthiness includes:

- the suitability of the boat and its propulsion for the type of activities and area of operations
- the physical condition of the boat itself
- proper loading with adequate freeboard
- carrying required and other necessary safety equipment
- operating within the limitations and capabilities of the skipper and crew
- complying with all regulations, including displaying correct navigation lights at night.

Information shown on the Australian Builders Plate

- 1** The plate's title, Australian Builders Plate.
- 2** The name of the boat's builder and either the Hull Identification Number (HIN) or the date built.
- 3** Maximum outboard engine power rating for which the boat has been designed and tested, expressed in kilowatts or horsepower.
- 4** Maximum outboard engine weight for which the boat has been designed and tested, expressed in kilograms.
- 5** Maximum number of persons on the boat, as recommended by the boat's builder, expressed in a whole number and in kilograms.

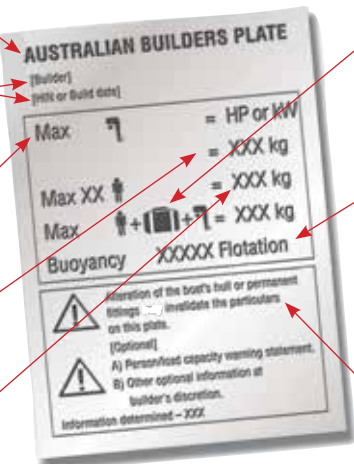

- 6** Maximum load for the boat, as recommended by the boat's builder, expressed in kilograms.
- 7** For boats less than 6 metres in length there will be a buoyancy statement. Up until 1 July 2006, the terms used may be either 'level flotation', 'basic flotation' or 'inadequate flotation'. After 1 July 2006, the term 'inadequate flotation' will no longer be allowed to be used.
- 8** A warning statement that if alterations make the boat different to the builder's specifications, the particulars on the Australia Builders Plate may be invalidated. The builder may also add other warning statements.

1.9 Registration

All boats fitted with a motor or auxiliary engine of 3kW or more require registration when on the water in Queensland. Registration forms are available from and must be lodged with Department of Transport and Main Roads customer service centres.

The boat will be allocated registration symbols. These must be clearly visible in plain characters in a contrasting colour to the hull of the boat. The size of the characters depends on the type of boat:

- boats capable of planing, for example speed boats and dinghies—minimum of 150 mm high on both sides
- for all other boats (excluding personal watercraft*)—minimum of 75 mm high on both sides or on the stern

*See page 86 for information on personal watercraft registration labels.



A label will be issued and must be placed on the exterior of the boat on the stern or port side near the registration symbols.

Tenders to registered Queensland regulated ships are exempt from registration provided they are used within two nautical miles of the primary boat. The tender must be marked with the word 'tender' as well as the primary boat's registration symbols, at least 75 mm high, on the exterior of the tender, or if this is not possible, marked on the inside of the boat in the largest characters practicable. The tender may be marked with the owner's name, if it is used for more than one of the owner's boats.

When a registered boat is sold it is the responsibility of the new owner to lodge an application for transfer of the registration within 14 days.

Registration fees are calculated according to the boat length. Exemptions are given to totally and permanently incapacitated war pensioners and concessions apply to some pensioners and Senior Card holders for one boat.

Recreational boats 15 metres and over

Applications for new registration, transfer of ownership or change of ship particulars for ships 15 metres and over must first be endorsed by Maritime Safety Queensland before they can be processed by a Department of Transport and Main Roads customer service centre. More information can be found on the Maritime Safety Queensland website.

1.10 Capacity specification

Overloading is dangerous and one of the easiest ways to capsize your boat. The more weight in the boat, the lower the freeboard. Freeboard is the minimum vertical distance from the surface of the water to the gunwale. The gunwale is the upper edge of an open boat. Overloading compromises the safety of everyone on board and increases the chance of swamping or capsizing.

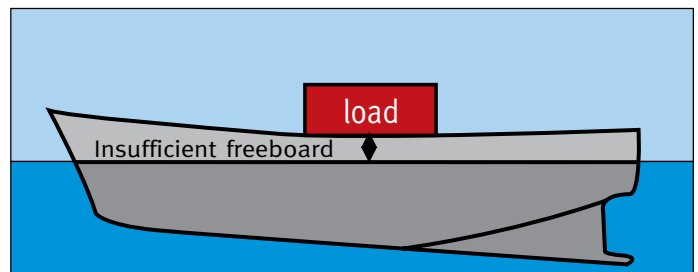
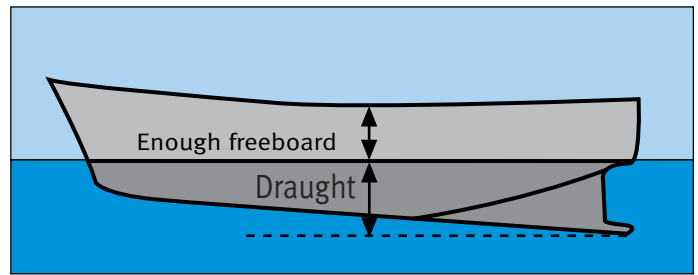

When preparing for a trip, the boat operator is responsible for assessing the load on board, both people and objects. Heavy items should be stowed in a low and central place where they cannot move around.

Weight, including passengers, should be distributed evenly through the boat. The weight of extra fuel and water should be taken into account.

All Queensland regulated ships, with some exceptions (for example sailing ships), must have one or more ABP attached. ABP should be placed near the boat's control area/s where they can be seen by the operator at all times. A penalty could apply if an ABP is not attached, unreadable or located in the wrong position on the boat.

The operator must keep in mind that the ABP indicates the number of people the boat can safely carry in good conditions and smooth waters. When using the boat in partially smooth or open waters or in rough conditions the operator should consider reducing the number of people taken on the trip. As a guide, reduce this number by one-third when boating on the open sea or in rougher conditions.

1.11 General safety obligation

All ship owners and operators are responsible for safety. The most important maritime safety principle is for operators to meet the 'general safety obligation' which encourages boat users to achieve the highest level of safety. Operators can achieve this obligation by ensuring their boat is:

- safe
- properly equipped and crewed
- operated in a safe manner.

Failure to meet this obligation can lead to prosecution and steep penalties. Some examples include:

Ensuring the boat is safe:

A boat is overloaded and swamped by a 'freak wave' and a passenger drowns. A court of law may find the operator negligent, declaring the boat was unsafe as it was unstable with so many people on board.

Ensuring the boat was properly equipped and crewed:

If passengers have never been on a boat before, it is the operator's responsibility to show them where the safety equipment is kept and how to put on a lifejacket. If a boat sinks and someone drowns as a result of not knowing where the personal flotation devices are stored or how to put one on, the operator can be prosecuted.

Ensuring the boat is operated in a safe manner:

If a boat is lost for a period of time and it is shown the operator was unable to read a chart, plot compass bearings and use a compass, that person may be found to have operated unsafely.

Section 1 activities

Activity 1

Label the picture of this boat using the list of terms provided.

- Bow**
- Stern**
- Chine**
- Keel**
- Transom**
- Helm**
- Deck**
- Port side**
- Starboard side**

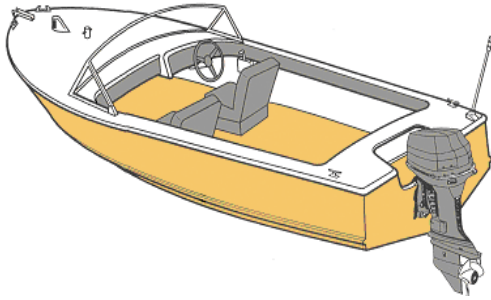

Activity 2

The two main kinds of boats are displacement and planing. In your own words what are the key differences between the two?

Displacement

Planing

Activity 3

The master of a boat is responsible for ensuring the boat is seaworthy for the voyage. Failure to do so puts lives at risk and may lead to a breach of your safety obligation. Write a list of conditions that, if met, will ensure a seaworthy boat.

Activity 4

What boats require registration?

Where are the registration numbers required to be displayed on a planing hull?

What is the minimum height for registration numbers on a planing hull?

Where can the registration numbers be displayed on a displacement hull?

What is the minimum height for registration numbers on a displacement hull?

Where must the registration label be displayed on the boat?

For a tender to be exempt from registration, what distance from the primary boat must the tender stay within?

Tenders must have the correct markings. What are the markings they require?

How does the master of a boat determine the safe carrying capacity of the boat?

When boating outside of smooth waters what is the recommended reduction of capacity?

Explain the general safety obligation.

Most boating accidents are the result of a series of smaller things going wrong. The more things that you get right, the less likely you are to hit big trouble. The time to start getting them right is before you set out. The safety and success of any boating trip are dependent on the level of preparation before you leave.

2.1 Trip plan

Plan all your day's boating activities, even the smallest trip. Know your destination and how to get there and back. Your voyage plan should include:

- where you intend going
- expected time of return
- the names and telephone numbers of people on board
- amount of fuel carried
- a list of safety equipment carried
- where you intend launching
- a description of your boat
- your boat, car and trailer registration numbers
- what to do if you do not return at the planned time (ring the police).

If you logged on by radio (see page 82), then don't forget to log off and, of course, you must follow the voyage plan. If the plans are changed, let rescue authorities know.

Let someone know before you go

Always let someone know your plans in plenty of detail. If your plans change, keep your contact person up to date. If possible, check in during the day by radio, and don't forget to report back when you return to shore. Think about using your local marine volunteer group, as they will keep a radio watch and set search and rescue in action if you fail to sign off at your prescribed time. Failing that, inform a responsible family member, friend or neighbour.

Log in by radio

In addition, boats going beyond smooth waters should log in with the local coast radio station, providing basic details of the destination, times and those on board. In addition to achieving a safety net, this process also ensures your radio is working effectively and makes your boat available to help others in trouble at sea.

2.2 Boat check

When you are preparing to go boating it is important to ensure your craft is in good order. You should make a habit of inspecting the key features of the boat each time before you leave home or the ramp, mooring or wharf. The major causes of breakdown at sea are fuel shortage or contamination, mechanical failure and battery failure.

- ☑ Before operating any switches or engines, check for petrol and/or liquid petroleum gas (LPG) odours. If such odours exist, fix the fault before you go out.
- ☑ Inspect the bilges. If there is more bilge water than usual, find and rectify the fault. When pumping bilges be aware of the environment. Polluting the waterways is an offence. If there is oil or fuel in the bilge water, use special absorbent pads to clean up and dispose of these appropriately. Such pads are available at leading marine stores.
- ☑ Check engine oil and coolant levels—top up if required.
- ☑ Examine marine batteries and terminals and ensure the connections are tight. Do the same for the second battery if carried.
- ☑ Check the engine—if it is not working properly, don't go out until the problem is identified and fixed.
- ☑ Check that the fire extinguisher is serviced, in good condition and ready for use. Read instructions, and know how to use the extinguisher before an emergency.
- ☑ Ensure there is sufficient fresh water and food for the length of the voyage with some extra in case of an emergency.
- ☑ Make sure your lights are in working order—it may be a daylight outing, but you could be delayed in returning.
- ☑ Test any electrics operating from the battery such as radios, gauges, power tilt and so on.
- ☑ Self-draining holes should be clear.
- ☑ Ropes and lines should be in good condition and stored ready for use.
- ☑ Steering cables and connections must be in good condition and work perfectly.
- ☑ Inspect the battery, recharge and renew regularly. Don't use car batteries for boats.
- ☑ Check that appropriate anchors are on board and are properly rigged, stowed and ready for use.
- ☑ One lifejacket should be available for each person on board.
- ☑ Children should have suitably-sized lifejackets. Look at means of rigging lifelines in open areas so that children have enough handholds.
- ☑ If you have a radio, make sure it is on and working. The best way to do this is to report the details of your boat and voyage to a coast radio station or local base station.
- ☑ Have up-to-date charts showing ports of refuge along your route.
- ☑ Ensure your first aid kit is complete.



- ☑ Ensure essential tools and spare parts are in good condition.
- ☑ Check all gear is properly stowed and secure.
- ☑ Keep a sharp knife in a handy place.
- ☑ Do not overload your boat.
- ☑ Ensure everyone on board knows where to find, and how to use, essential safety equipment such as lifejackets and fire extinguishers. Show others how to operate the ship and radio and how to deal with emergencies.
- ☑ Don't forget the bung.

Fuel

- ☑ Check fuel levels, top up if required.
- ☑ Ensure there is enough fuel for the duration of time you intend being out, plus one third in reserve. Your engine will use more fuel in rough conditions so calculate your fuel usage based on the worst conditions you will meet.
- ☑ Spare fuel should be carried in an approved container.
- ☑ Fuel should be fresh. Make sure it is not last season's fuel that may be contaminated.

Stability

- ☑ Overloading a boat is dangerous. Consider the carrying capacity (see page 16), heavy equipment and extra fuel cans. The operator should ensure the boat is in a proper 'seaworthy' condition and that it is used within its operating design limitations.
- ☑ Stow all gear securely and distribute weight evenly to achieve proper trim and no list.
- ☑ Keep bilges dry and decks and drains clear.

Safety equipment

- ☑ Ensure the correct safety equipment is on board for the area you intend to operate in and for the possible hazards you can foresee.
- ☑ All safety equipment must be properly stowed, easily accessible and in good working order.
- ☑ Check expiry dates of EPIRBs and flares/smoke signals.
- ☑ Know how to use all safety equipment. Let everyone on board know what safety equipment is carried, where it is stored and how it works.
- ☑ Know methods of emergency signalling.
- ☑ Carry a radio. A pocket transistor will give weather forecasts. For a little more expense, marine transceivers on 27 MHz and VHF will keep you in touch with all marine services and bring speedy help if you get into trouble.
- ☑ When cooking devices are installed, a fire extinguisher and fire blanket should be carried and stored in an accessible place, away from the stove.
- ☑ Ensure people on board have any required medication and that they know how to administer it.

Weather

- ☑ Check the weather and know what changes may occur.
- ☑ Prepare contingency plans for shelter.



Emergencies

Readiness for emergency situations means planning ahead, considering what could happen, and taking action to control it.

- ☑ Develop a safety plan so everyone on board knows what to do in an emergency. Be prepared for any unusual situations by making your own mental 'what if' checklist.
- ☑ Being able to communicate with someone on shore will greatly improve your chances of solving any boating problem. A marine radio is highly recommended.
- ☑ Ensure everyone knows how to swim or tread water.
- ☑ Ensure everyone knows how to properly don a lifejacket.
- ☑ Always carry safety equipment so if something goes wrong you will still have options.

Clothing

- ☑ Skin should not be overly exposed to sunlight, either direct or reflected, wind and water.
- ☑ Carry adequate wet weather gear for the trip you are planning.
- ☑ Clothing should offer protection from the elements and not restrict your movements. Avoid clothing that will significantly reduce buoyancy. If cold, wear a buoyancy garment.
- ☑ Check your ability to swim or float in your clothes in case the boat sinks. Try it out in shallow water. Children, weak or non-swimmers should wear a lifejacket.
- ☑ Remember it's always colder on the water and the sun is stronger—extra jumpers, waterproofs and sunscreen are never a waste of space.

Navigation

- ☑ Know exactly where you are going, how to get there and how long it will take to get back.
- ☑ Check the tides, tidal flow and bar conditions as appropriate.

- ☑ Find out about any local dangers and special rules or regulations for the boating area you are operating in. Information can be obtained from local or official charts, signage at boat ramps or from rescue groups and maritime authorities.
- ☑ Coastal navigation courses are highly recommended.

Taking off

- ☑ Many injuries occur because people fall overboard while the boat is in motion.
- ☑ Never stand or sit on the bow of a boat not specifically designed to have persons in the bow, or dangle legs in the water, while the boat is moving.
- ☑ Insist everyone aboard is within the boat itself, not on the side decking, and especially not on the bow or where the view is obstructed.
- ☑ Keep to the centre of the boat for stability.
- ☑ Move off slowly. The same goes for returning to the jetty, mooring or ramp.
- ☑ Always check for trailing ropes that may be caught in your propeller.
- ☑ Speed is for open waters and straight passage-making, not for manoeuvring close to shore or other boats, or near people in the water.

2.3 Routine maintenance

Boats operate in harsh conditions—salt water, vibration, sand, sun and rain combine to make life tough on the machinery. Trouble-free performance means treating it well. Almost all elements of safety revolve around boat maintenance where all its parts and systems are able to perform as they were designed. Negligence in this area will eventually lead to an unsafe or disastrous experience.

Regular preventative maintenance and engine servicing by a qualified mechanic may avoid a breakdown at sea. A full service at least once a year is a minimum requirement, but it should be serviced more frequently if used often, or if left where corrosion is more likely to occur. Refer to the manufacturer's recommendations in the engine handbook (most manufacturers recommend a full service every 100 hours).

Prepare a safety checklist as a reminder of items that may require service, maintenance or simply a periodic check.

Before you use your motor, be familiar with the manual. Manufacturers' manuals contain everything you need to know about your motor, information on approved service agents, availability of spares, and a 'troubleshooting' page for minor faults and emergencies at sea. However, don't be tempted to tinker beyond what you can confidently do.

Preventative maintenance

Give your boat and equipment a thorough pre-season check before heading out for the first day on the water. Lesser checks should be undertaken mid-season and also before every trip.



Fuel filter

Engine care

Manufacturers usually recommend a service by a specialised workshop at least once a year. Regular inspection and maintenance will ensure some of the following parts won't let you down.

Water pump

- ☑ Replace impeller regularly, especially if you have been operating in the shallows and stirring sand. Water pump impellers also deteriorate if not used for lengthy periods.
- ☑ Make sure water is being discharged from the exhaust system or telltale when started.
- ☑ Regularly check for water leaks. A water pressure gauge on motors 50 hp and over is an advantage.

Propellers

The bushing of the propeller can fail, especially if it has hit sand or rocks. Some older models have a shear pin to keep the propellers in place.

- ☑ Carry a spare shear pin when appropriate and a spare propeller.
- ☑ Keep shafts and props in clean and good working order.
- ☑ Remove fishing line.
- ☑ Carry a suitable spanner to undo the nut for the propeller.



Spark plugs

Spark plugs can break down.

- ☑ Carry new spares—never keep old plugs as a standby for emergency use.
- ☑ Clean spark plugs, check gap or replace (recommend every 100 hours).

Gearbox oil

Snagged fishing line is a common cause of leaking gearbox seals. Water in the gearbox will eventually cause it to fail, potentially while you are at sea.

- ☑ Change oil regularly.
- ☑ Check your propeller shaft frequently for caught line.
- ☑ Check and refill gear case oil regularly.
- ☑ Check and service transmissions and lower units according to manufacturer's recommendations.

Fuel system

Fuel defects are a common cause of engine problems.

- ☑ Always replace old fuel with new fuel after periods of inactivity or drain tanks if not in use.
- ☑ Inspect fuel lines, manual priming bulb, shut-off valves, pumps and connections for cracks, corrosion, wear, hardening and leaks.
- ☑ Filters become clogged. Check, clean and/or change filters frequently to be assured of clean fuel entering your engine.

LPG

LPG is the most dangerous substance on boats if not handled correctly. Safe gas practices include:

- ☑ Ensure all LPG installations are carried out and serviced by a licensed gas fitter.
- ☑ Gas cylinders should be professionally inspected regularly to ensure equipment and hoses are in safe working order.
- ☑ All LPG appliances should be fixed firmly in place to ensure that boat movement cannot disturb them.
- ☑ Ensure all appliances are protected from draughts.
- ☑ Check appliances have flame failure, or, if otherwise approved, reliable gas detection equipment fitted.
- ☑ Ensure LPG cylinders and appliances are suitable for marine applications. Ask your marine dealer or LPG appliance supplier for advice.
- ☑ Always keep cylinders upright and on a stable base.
- ☑ Ensure storage bottles are enclosed and upper-deck stowage is vented so any escaping gas drains overboard (LPG has the same characteristics as water and will flow downwards and gather in the bilge).
- ☑ Ensure systems are maintained and monitored to minimise the possibility of leaks.



Batteries

Battery maintenance is important as a flat battery is a common cause of rescue call-outs. Large boats take considerable cranking power to start. The battery will provide this, but every time you turn the motor over, it drains battery power. If your battery is weak, a few starts will drain the battery below the capability of the motor to charge it. It is therefore essential to have your battery in peak condition for every journey. Remember, you can't pull-start a 150kW motor.

- ☑ Use a good-quality marine battery—check it, charge it and change it at regular intervals.
- ☑ Batteries should always be secured in brackets.
- ☑ If in enclosed space, ensure it is properly ventilated.
- ☑ Terminals, cables or casing should be kept clean. Grease terminals regularly.
- ☑ Terminals and connections must be tight and secure.
- ☑ Top up battery cells with distilled water and check each cell with a hydrometer.
- ☑ The battery should be charged at a rate that is suitable to the battery and should never be overcharged.



- ☑ Turn off the power to the charger before disconnecting the charging pads. This may prevent an explosion.

Electrical system

A common cause of equipment failure is through corroded electrical systems. By the nature of what a boat does and how it does it, it is a floating corrosion pit, especially when operating in salt water.

- ☑ Keep all electrical systems clean and corrosion free by frequent inspection.
- ☑ Spray terminals, electrical connectors, and so on with a corrosion-retarding agent such as Pertox, CRC or WD40.
- ☑ Keep all electrical fittings dry.
- ☑ Check the lights are working even if expected to be out only during daylight hours.

Anodes

Disintegration of an anode (fitted to protect an engine from galvanic corrosion) is normal and indicates it is working.

- ☑ Check anodes periodically and replace when smaller than 60% of their original size.

Pumps

- ☑ Test bilge pumps for efficient operation and service as required.

General check of boat

If at all possible, keep your boat under cover in a garage, carport or boat storage unit. At a minimum, keep a cover on your boat to protect the topsides, floors, seats and so forth, from the effects of the sun and rain.

- ☑ Wash down regularly and after each use.
- ☑ Inspect boat for corrosion, cracks, wear and tear. Touch-up with paint and wax.
- ☑ Ensure the bung is suitable and in good condition.
- ☑ Self-draining holes must be clear. Check drain flaps and grease them if necessary.
- ☑ Ensure bilges are clean and dry.
- ☑ For protection and efficiency, keep the hull and decks of the boat clean and properly waxed. Fibreglass should be cleaned with fresh water and a non-abrasive soap. If necessary, a soft brush should be used to help remove debris caught in crevices. Patch any cracks that may occur due to stress, age or accident.
- ☑ Keep all aluminium and stainless parts clean and polished with a good metal wax. Metals on boats corrode quickly, especially in a salt water environment, if not adequately maintained.
- ☑ Check all screws, bolts and other fittings to keep secure.

Safety equipment

- ☑ Inspect all safety equipment for any deterioration or damage (check expiry and service dates).
- ☑ Refresh your knowledge of the use of the equipment.
- ☑ Inspect anchor, shackles, chain and line for any sign of wear or corrosion and replace if necessary.

Extra checks

- ☑ Inspect tool kit for any tools, spare parts and odds and ends.
- ☑ Replenish water supply.
- ☑ Ropes and lines should be in good condition and stored ready for use.

After every trip

A few minutes spent on basic preventative maintenance every time your motor has been used will pay off in hassle-free boating later on.

In addition to the checks above:

- ☑ Flush your engine with fresh water as soon as possible after each use in salty, polluted or brackish water. Flushing will minimise the formation of deposits that can clog cooling passages. See your dealer for a suitable flushing device and anti-corrosion flushing liquid and follow manufacturers instructions.
- ☑ Take off the engine cover, check connections and spray with water dispersant.
- ☑ Wash down the exterior of the motor with fresh water and then dry off.
- ☑ Before putting the boat away, spare a thought for the trailer. Have a look at the towing hitch, check the lights and most importantly make sure that the wheel bearings are well greased and do not have salt water in them. This is the greatest cause of trailer trouble and also the most neglected.

2.4 Tools and spares

It is not difficult to correct minor faults in engines or to carry out the basic maintenance essential to good, reliable performance, but none of these can be achieved without an adequate tool kit which should be on board the boat whenever it is in use. Remember, help is not always easy to find out on the water.



Recommended minimum spare parts and tools follow:

Spares	Outboard	Inboard
Spark plugs	✓	✓
Replacement fuses	✓	✓
Fuel filters	✓	✓
Starter cord	✓	
Shear pins for propeller/spare nuts and bolts	✓	✓
Propeller	✓	
Spare fuel line	✓	✓
Spare bung	✓	✓
Spare oil/hydraulic fluid	✓	✓

Tools	Outboard	Inboard
Engine manual	✓	✓
Pliers	✓	✓
De-watering spray	✓	✓
Spark plug spanner that fits (injector spanner)	✓	✓
Oil/fuel funnel	✓	✓
Propeller spanner	✓	✓

Consult your engine handbook for any additional spares and tools that may be required.

Regularly check your tool kit and replenish any spare parts used.

2.5 Fuel



Fuel is a vital element of successful boating. Running out of fuel, fire risks associated with fuel and disabled engines resulting from incorrect or dirty fuel or excess moisture in the fuel, can lead to serious emergencies afloat.

Carry sufficient fuel

Always check your fuel levels before every trip. Carry enough for the trip with an adequate reserve for heavy weather, contingencies and emergencies. Plan to arrive home with at least 30% of your fuel intact. Carry spare fuel in approved airtight containers. It is advisable to always use fresh fuel.

Minimise fire/explosion risks

Fuel is a major cause of fires or explosions afloat. Such fires generally result when some component of the fuel system starts to leak and vapours trapped in the boat bilge are ignited. Fuel systems comprise one or more tanks, valves, lines, pumps and filters. Each of these elements, if left unserviced, can be potentially hazardous.

Regularly inspect and maintain fuel tanks and lines to ensure they are in good condition and do not leak. Check the tank often for potential corrosion that could cause leakage. Inspect the shutoff valves, lines, and pumps periodically for corrosion or wear. Urgently rectify any temporary or 'stopgap' solutions to fix leaks.

The most important tool you have to diagnose problems in the fuel system is your nose. If you smell fuel—find the problem.



Use clean, fresh fuel

Fuel does go off. Clean out the fuel tank periodically (at least yearly) and always replace old fuel after a period of inactivity.

Older two-stroke outboards use oil pre-mixed with fuel. If this mixture is left in the tank for any length of time the oil will break down and fail to lubricate the motor, also sludge will form which will block up the fuel system when the engine is started. It is better to empty the tank and mix fresh fuel next time the engine is to be used.

For direct injection motors where the oil is not mixed with the fuel, ensure the oil reservoirs are kept full.

Check and change filters frequently to be assured of clean fuel entering your engine. Carry spare filters.

Keep tanks topped-up and close them up when not in use. This minimises the chance of condensation occurring and water getting into your fuel.



Vessel securely moored
Engines, systems shut down
Hatches closed

Extinguisher nearby
Nozzle earthed
Bystanders clear

Refuelling

Proper refuelling procedures are very important in preventing on board fires. Petrol vapours are heavier than air and can spread rapidly into enclosed spaces. Check the bilges and all closed compartments for petrol vapours. If you smell fuel, check for leaks.

Never refill portable fuel tanks in the boat—take them ashore for filling and wipe off any spillage before replacing them aboard.

Marine refuelling instructions

Before refuelling	During refuelling	After refuelling
Shut down engine	Maintain contact between the hose nozzle and fixed pipe to prevent static sparks	Make sure there is no smell of fuel from the bilges
Take portable tank to be filled to a place safely clear of the boat	Avoid spillage either into the boat or into the water	If fuel has spilt, pump out bilges manually and leave boat wide open for at least 30 minutes
Cut off electric power at main switch	Contain potential spills, plug scuppers. Do not operate radios or mobile phones	Clean up spills with absorbent materials

2.6 Safety equipment table

Carrying the right safety equipment and knowing how to use it is essential. The tables below outline the minimum equipment requirements set by legislation. Size of the boat, whether it requires registration, the age of passengers, and the areas of operation are among the determining factors. Water limit maps starting on page 26 indicate the three designated water types along the Queensland coast. Consider your entire trip, including areas through which you are only traversing when equipping your boat.

Safety equipment requirements are divided into three areas:

- compulsory equipment for all boats
- compulsory equipment for all registrable boats
- recommended equipment.

While it is not compulsory for boats not requiring registration to carry some of the safety equipment listed, it is strongly recommended to take extra in case of an emergency. Carry the maximum safety equipment to be prepared for the unexpected. Failing to be prepared could lead to breaching the general safety obligation.

Safety equipment for Queensland regulated ships

All equipment must be in good working order. For EPIRBs, fire extinguisher, flares and inflatable life jackets, check the service expiry or replacement date. Make sure yours are current.

- Boats not requiring registration means recreational boats with an engine or auxiliary under 3 kW. Requirements or recommendations listed also apply to international or interstate boats operating in Queensland.
- Boats requiring registration means recreational boats with an engine or auxiliary of 3 kW or more. Requirements or recommendations listed also apply to international or interstate boats operating in Queensland.
- Tenders do not require registration if operated within 2 nautical miles (nm) of the primary boat. Tenders that do not require registration are not required to carry safety equipment other than a light for signalling. Operators should consider equipping a tender with safety equipment appropriate to the location of operation.
- PWC means personal watercraft for example a jet ski.
- Required means equipment that must be carried. Recommended means equipment that is suggested to be carried to meet the General Safety Obligation.

Item	Smooth water			Partially smooth waters			Beyond smooth and partially smooth waters		
	Not requiring registration	Registered*	PWC	Not requiring registration	Registered*	PWC	Not requiring registration	Registered*	PWC
EPIRB*(406 MHz) Emergency Position Indicating Radio Beacon. When operating more than 2nm from land and not within smooth and partially smooth waters. Must be registered with AMSA. Registration must be renewed every two years.							required	required	required
EPIRBs must have a printed expiry date and be replaced or serviced by the manufacturer (or authorised service agent) by this date; must comply with Australian Standard AS/NZ 4280.1:2003; and must be registered in the name of the owner/master with AMSA.									
Signalling device For example a torch, or fluorescent light, or lantern or cyalume stick. Required when operating between sunset and sunrise.	required	required	required	required	required	required	required	required	required
Lifejackets* • One of the appropriate size for each person (12 months and over) on board, except if a person is wearing an inflatable diver jacket and the vessel is engaged in diving activities. • Children under 12 must wear the lifejacket when underway in an open boat under 4.8m. • Lifejackets must be worn when crossing designated coastal bars in open boats under 4.8m. • Skiers or people being towed + At least level 50 or level 50 special purpose, or wetsuit with inbuilt flotation approved as level 50 special purpose in smooth waters. + At least level 50 in partially smooth waters.	Level 275, 150, 100, level 50 or level 50 special purpose recommended	Level 275, 150, 100, level 50 or level 50 special purpose required	Level 50 or level 50 special purpose required	Level 275, 150, 100, or level 50 recommended	Level 275, 150, 100, or level 50 required	Level 50 required	Level 275, 150 or 100 recommended	Level 275, 150 or 100 required	Level 50 required
<ul style="list-style-type: none"> • Lifejackets not required if a ship, other than a PWC, has a level flotation statement in the approved form and is operating in a river, creek, stream, or the waters contained within breakwaters or revetments and is equipped with grab lines, grab rails or other permanent means of giving each person on board a way of keeping a secure hold to the ship. • Lifejackets not required for a registered* tender when the tender has a level flotation statement in the approved form and is operating within 1km of the parent ship. • Lifejacket not required for a registered* tender when the tender has a level flotation statement in the approved form and is operating within 1km of the parent ship. • Lifejacket not required for a registered* tender when the tender has a level flotation statement in the approved form and is operating within 500m of the parent ship. 									
V sheet				recommended	required	required [^]	recommended	required	required [^]
Flares Two red hand flares and two hand held orange smoke signals.				recommended	required	required [^]	recommended	required	required [^]
Fire fighting equipment All boats over 5m. Must be capable of extinguishing a fire quickly and effectively.	recommended	required		recommended	required		recommended	required	
Navigation A chart and a liquid damped compass appropriate to the operational area, or other directional finding or positioning equipment. For a PWC without a chart or compass, an electronic navigation device appropriate to the operational area.				recommended	recommended	recommended [^]	recommended	recommended	recommended [^]
Anchoring For boats less than 5m, the cable can be chain or rope. For boats over 5m, the cable can be chain of at least 2m attached to anchor and rope. The type and weight of anchor and length and thickness of the cable should be appropriate for the type and weight of ship, the weather and sea conditions and the nature of the seabed.	recommended	recommended		recommended	recommended	recommended ^{^o}	recommended	recommended	recommended ^{^o}
<ul style="list-style-type: none"> • less than 5m: one anchor with at least 18m of cable • 5m to less than 8m: one anchor with at least 27m of cable • 8m and over: two anchors with at least 37m of cable each • less than 5m: one anchor with at least 27m of cable • 5m to less than 8m: one anchor with at least 27m of cable • 8m and over: two anchors with at least 37m of cable each • less than 5m: one anchor with at least 27m of cable • 5m to less than 8m: one anchor with at least 27m of cable • 8m and over: two anchors with at least 37m of cable each 									
Pumping/bailing equipment	recommended	recommended		recommended	recommended		recommended	recommended	
<ul style="list-style-type: none"> • less than 5m: suitable bailing equipment • 5m to less than 8m: bilge pump 45L/minute capacity • 8m and over: bilge pump 70L/minute capacity • less than 5m: suitable bailing equipment • 5m to less than 8m: bilge pump 45L/minute capacity • 8m and over: bilge pump 70L/minute capacity • less than 5m: suitable bailing equipment • 5m to less than 8m: bilge pump 45L/minute capacity • 8m and over: bilge pump 70L/minute capacity 									
Manual propulsion Oars or paddles (boats under 6m).	recommended	recommended		recommended	recommended		recommended	recommended	
Drinking water Enough for everyone on board for the trip.	recommended	recommended		recommended	recommended	recommended [^]	recommended	recommended	recommended [^]

* Also includes boats/tenders that are required to be registered but are not.

[^] Does not apply to a PWC operating in an approved aquatic event or beyond partially smooth waters and within 0.5 nautical miles from land.

Owners/masters must give each person on board information about where the safety equipment is kept. Lifejackets must be clearly visible to passengers or readily accessible and indicated by a clearly visible sign with a white background marked with the word 'lifejackets' in red letters or vice versa.





^o It is recommended the type and weight of anchor and the length and thickness of the cable should be appropriate for the type and weight of the PWC, the weather and sea conditions and the nature of the seabed.

2.7 Water limits

Water limits determine the types of safety equipment required.

- Smooth waters include rivers, creeks, streams and lakes, waters within breakwaters or revetments and within half a nautical mile from land within partially smooth limits and other waters specified in legislation.
- Partially smooth waters are determined by Maritime Safety Queensland as specified in legislation.
- Open waters are areas beyond these limits.
- The red line designates limits beyond which EPIRBs must be carried.

Water limit legend:

-  Smooth waters
-  Partially smooth waters
-  Open waters
-  The red line designates limits beyond which EPIRBs must be carried.



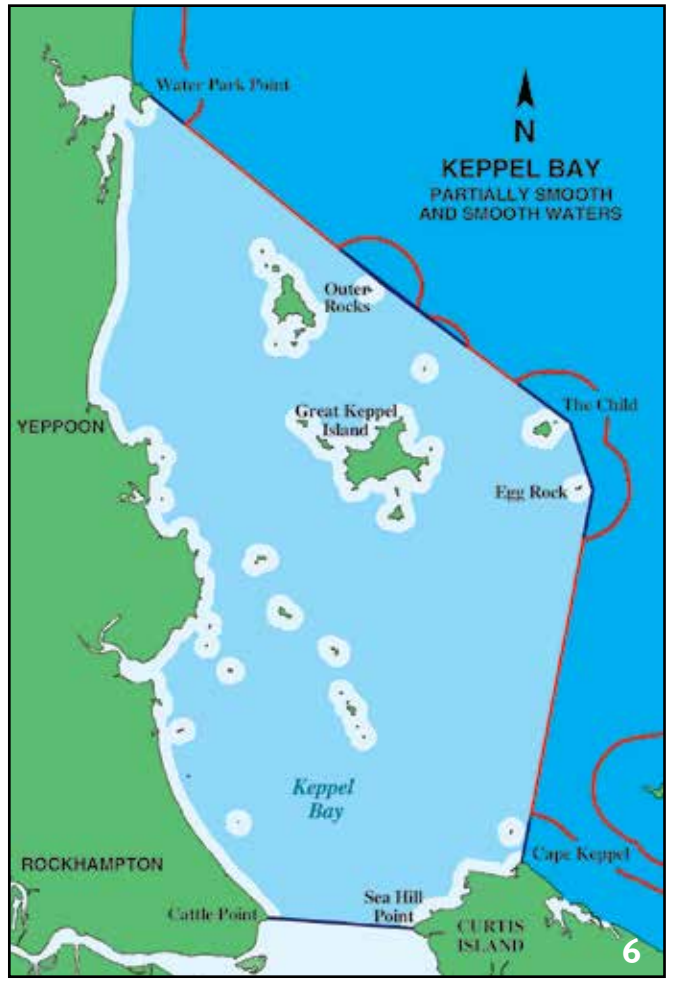

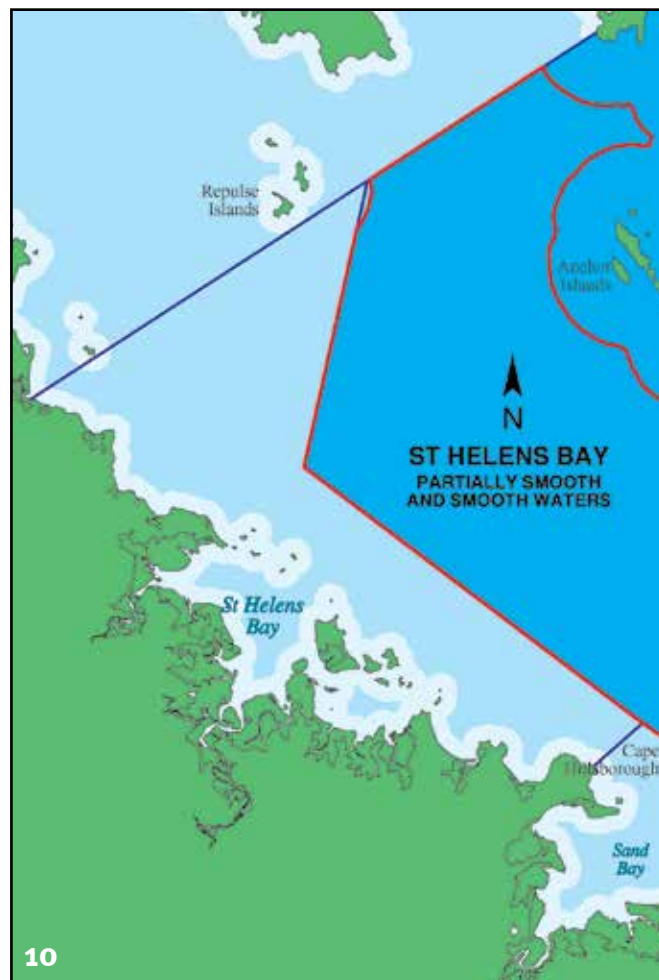

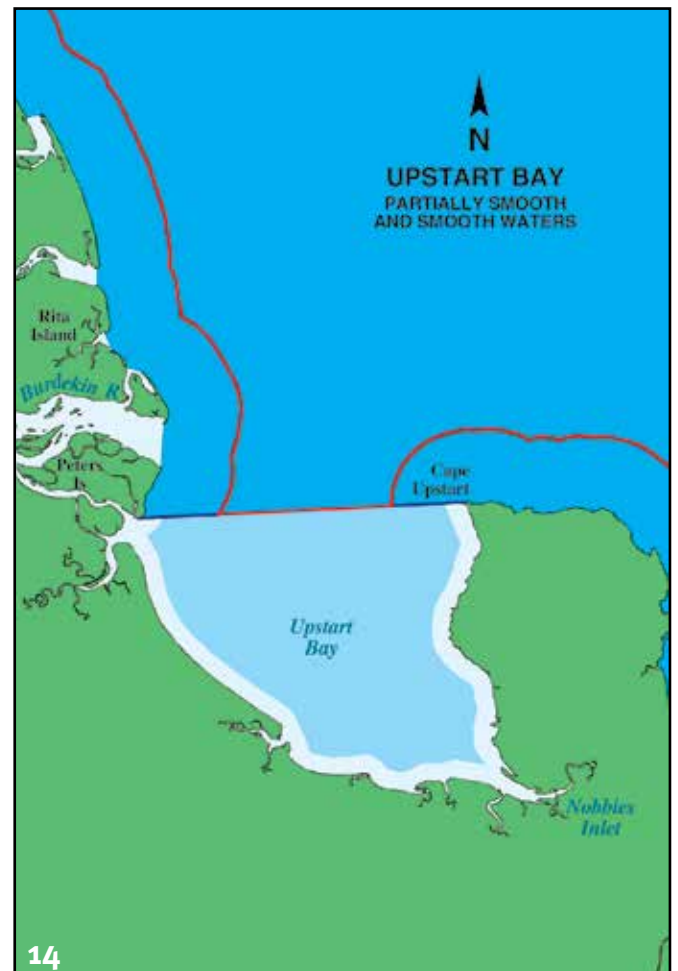
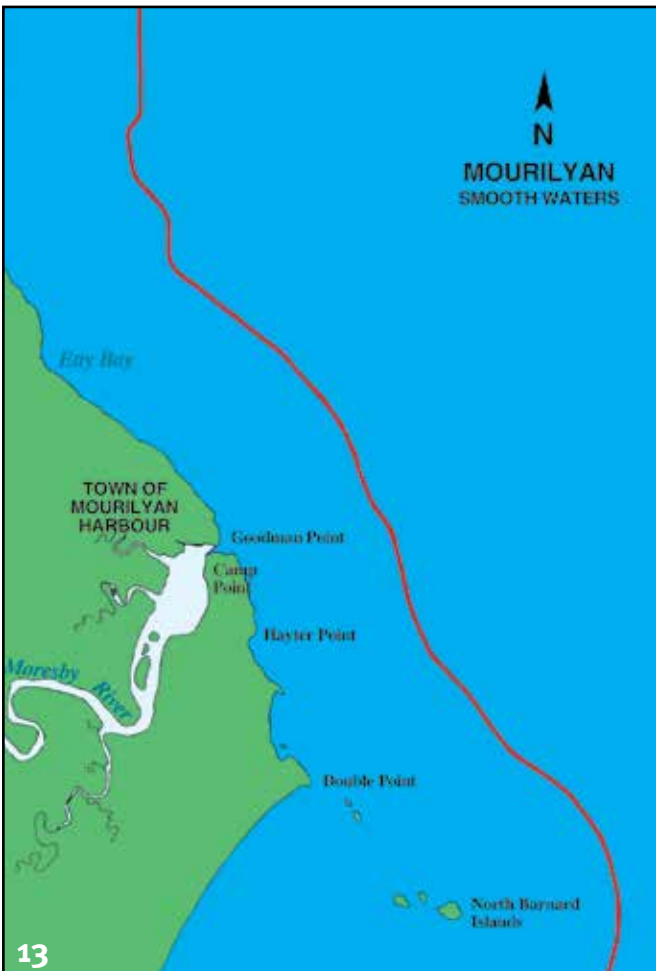
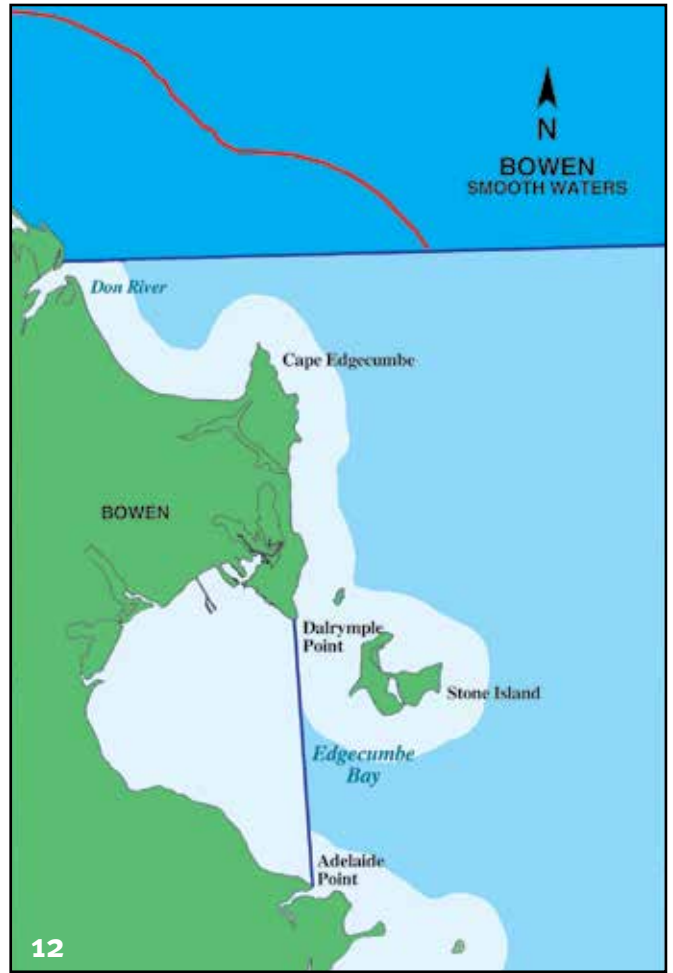
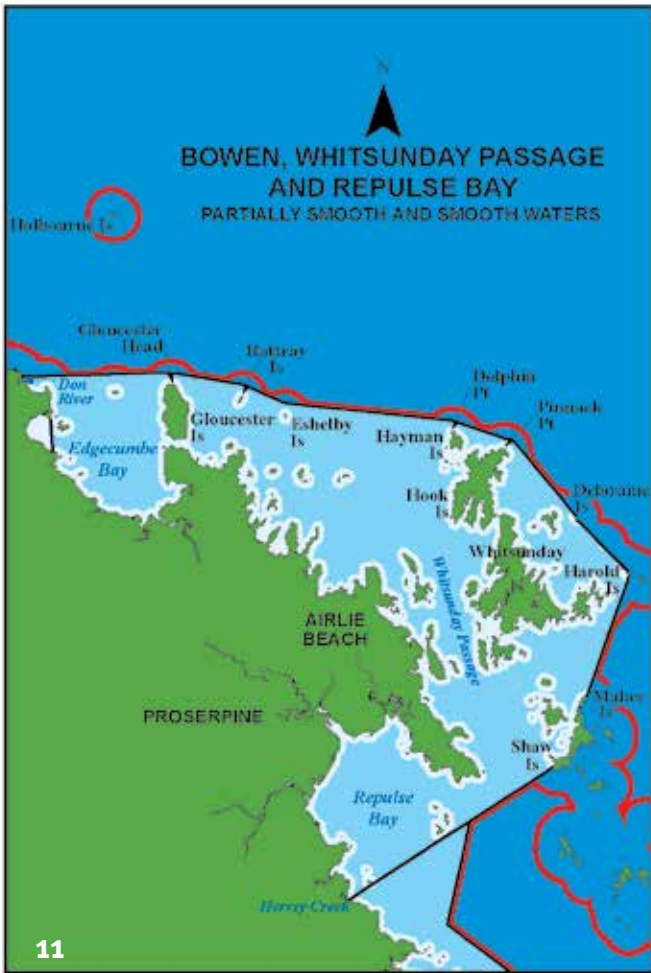

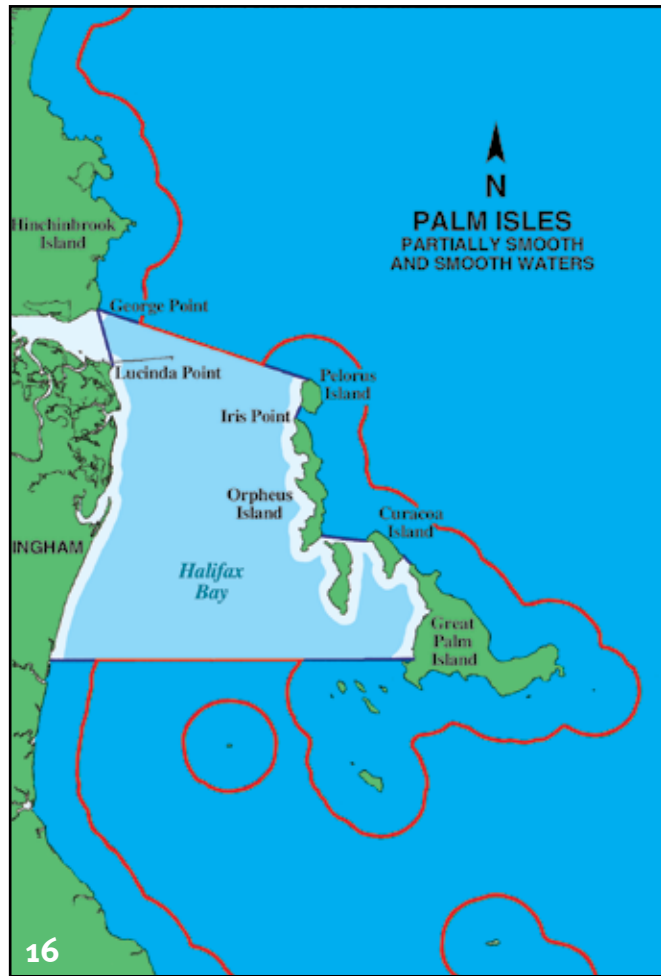

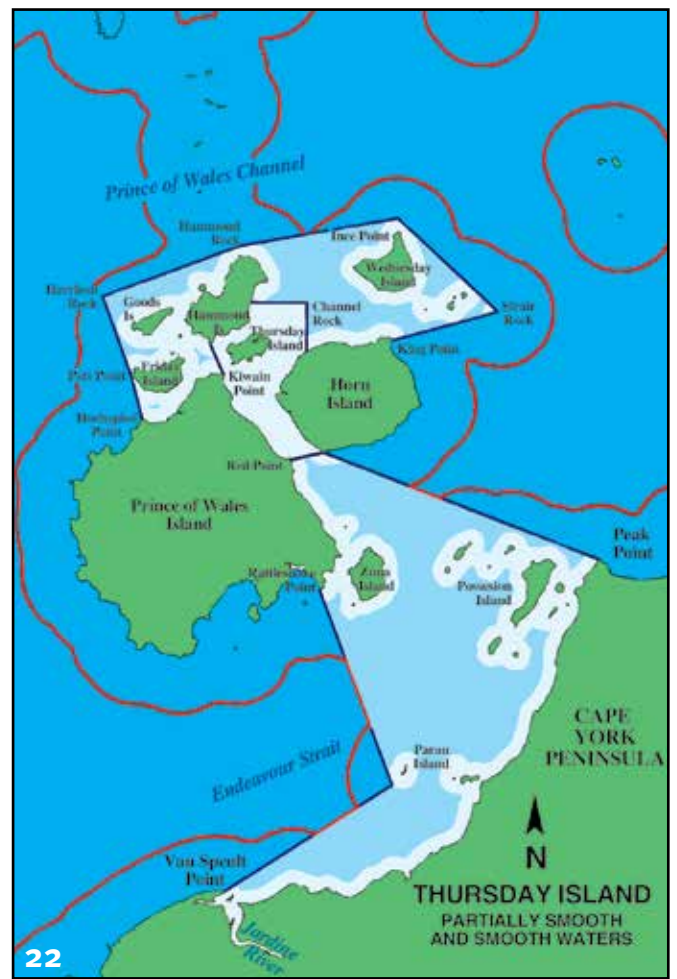
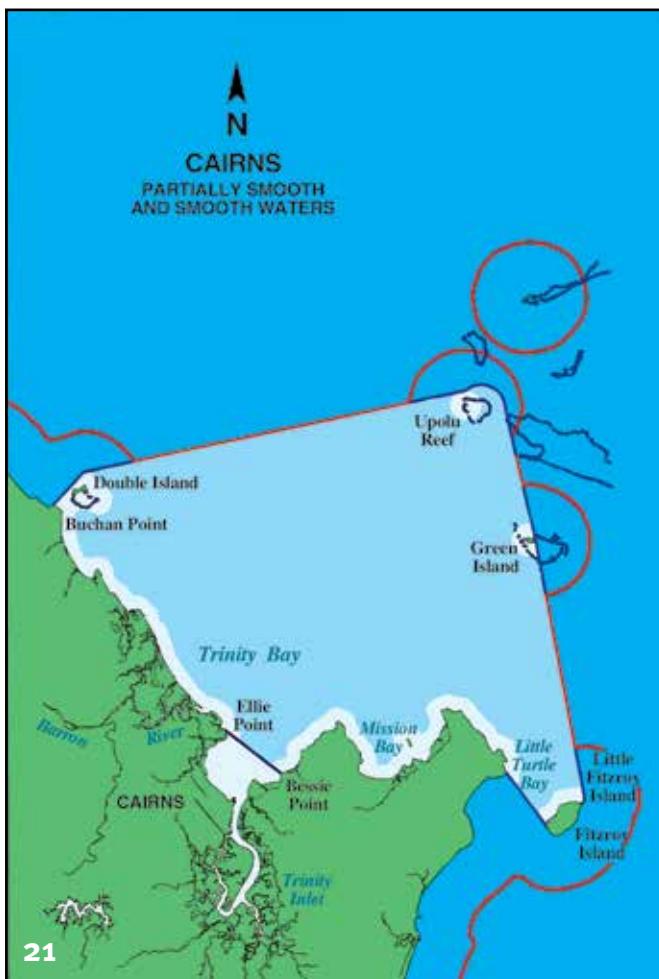
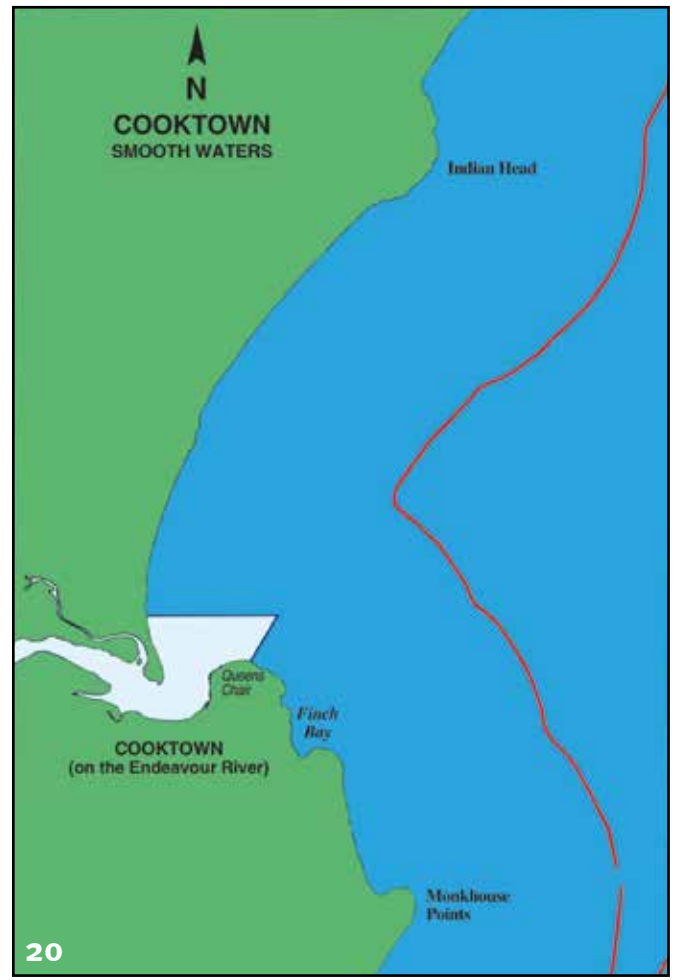

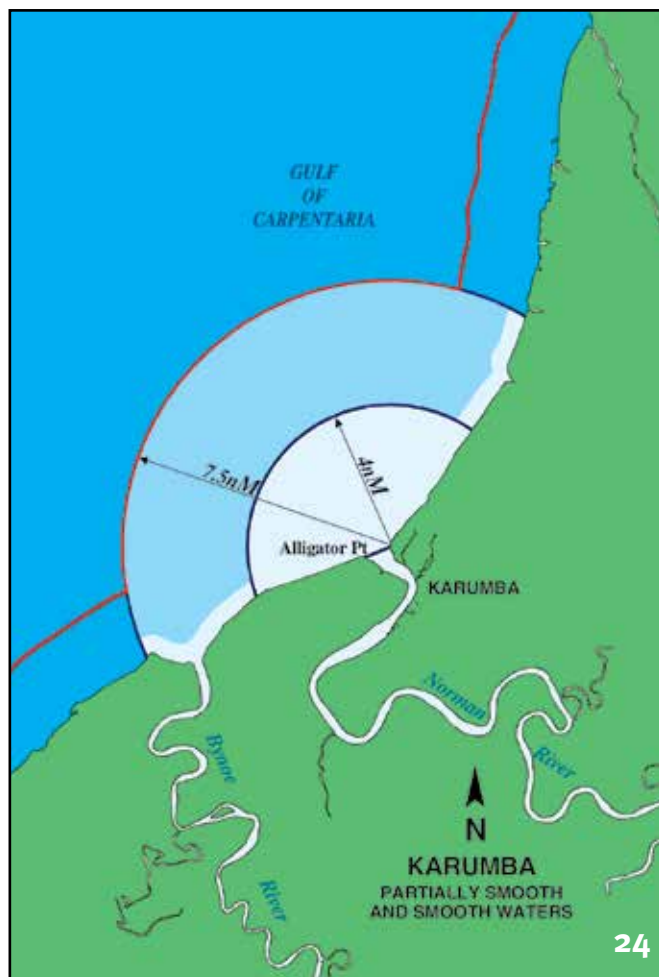

2.8 Safety equipment

Lifejackets are suited to varying conditions and activities

Emergencies can happen quickly out on the water, even when conditions look calm.

In a life-threatening situation, experience has shown often there is not enough time to put a lifejacket on.

It's not a lifesaver unless you're wearing it.

Level 275, 150 or 100



Smooth, partially smooth and open waters

Level 50



Smooth and partially smooth waters

Level 50 special purpose



Smooth waters only

Coastal/SOLAS
Level 275, 150 or 100



Offshore



23

24

Personal equipment

Lifejackets

Lifejackets are the most important piece of safety equipment on any boat. They must comply with the standard and be the right size. They should be kept in an accessible position and not used as cushions and fenders.

The stowage compartment for lifejackets is to be clearly labelled and visible to passengers. Labels must have the word 'lifejacket' in red text on a white background or white text on a red background.

Wearing of lifejackets is now compulsory for everyone aged one year or over in open boats under 4.8 metres while crossing a designated coastal bar. Children under the age of 12 years in open boats under 4.8 metres must wear a lifejacket while underway, this includes when drifting.

Safety can also be enhanced if lifejackets are worn in the following circumstances:

- at the first sign of bad weather
- in an emergency situation
- between sunset and sunrise or during restricted visibility
- when operating in unfamiliar waters
- when operating with a following sea
- when boating alone
- at all times on poor swimmers and children under 12 (compulsory when underway in open boats less than 4.8 m).

Practise putting them on in the dark and in the water—it is harder than you think!

Types of lifejackets

Level 275, 150 or 100—has a flotation collar to keep the head above water. They are in highly visible colours (orange and/or yellow) and have reflective tape to increase visibility at night. They can be used in all waters but are most useful when boating offshore or in rough weather.

Level 50—does not have a collar to keep the head above water. They are manufactured in visible safety colours and are good for waterskiing, PWC (jetskis), sailing boats and dinghies, where the user is in the water only for a short time. They are not designed to maintain a person (especially an unconscious person) in a safe floating position.

Level 50 special purpose—has the same buoyancy as a Level 50 lifejacket although colours are not as visible. It may be a specified buoyancy wetsuit. These are not recommended for general boating use because the colours are less visible in search and rescue operations.

COASTAL and Safety of Life at Sea (SOLAS) lifejackets—are designed to keep the body afloat for long periods of time. They have reflective tape to improve visibility at night and a whistle attached to attract attention. These jackets are mostly carried by commercial boats and should be carried on boats operating long distances from shore.

Lifejackets on children

When choosing a lifejacket for a child (aged one year or more), care must be taken to ensure it fits properly and the child would not slip out when in the water.

Inflatable lifejackets

Inflatable lifejackets are available that are compact and suitable for wearing while being active around the boat. Many are approved as a level 275, 150 or 100 lifejackets, and require their gas cylinder serviced periodically.

One type of inflatable lifejacket, otherwise known as a 'bum bag', is packed in a pouch and hung around the waist. When it is required for a lifejacket to be worn, for example crossing a bar in a boat less than 4.8 metres, these should be unpacked and worn around the neck, ready for inflation.

Lifejacket standards

All approved lifejackets require markings that can be used to identify them as meeting the Australian Standard.

Lifejackets that are manufactured to comply with the Australian Standard require legible markings which include the following:

- manufacturer's name, trade name or trademark
- the words level 275, 150 or 100, level 50, or level 50 special purpose
- manufacturer's model identification, batch identification and year of manufacture
- intended body mass range
- illustrated instructions for donning the lifejacket
- instructions for storage and care
- information relating to replacement or checking of gas cylinders of inflatable lifejackets.



BSI Benchmark



Australian Standard
SAI Global



Global Mark

Signalling equipment

EPIRBs

An EPIRB is a compact, buoyant, self-contained radio transmitter which continuously emits a distinctive radio signal to aircraft and satellites for at least 48 hours when activated. When the signal is detected, the Rescue Coordination Centre initiates a response using available rescue services.

The standard EPIRB is the digital 406 MHz. Analogue 121.5 MHz EPIRBs are no longer monitored by the satellite system.

The 406 MHz has the following features:

- Timeliness—search and rescue (SAR) authorities can be alerted within three minutes by the geostationary satellites and on average within 90 minutes using the orbiting satellites.
- Accurate to approximately 5 kilometres. This is improved to about 120 m with a built-in GPS.
- Identifies the unit in trouble—units must be registered to an international database at the Australian Maritime Safety Authority (AMSA) which records ship details to aid rescue and minimises false alerts.
- Digital transmission—more reliable than the obsolete analogue 121.5 MHz model. Higher powered, more robust, aural/visual monitor (strobe light to assist night rescue) and less interference.

EPIRB registration is issued by the Australian Maritime Safety Authority (AMSA). EPIRB owners must be able to provide marine inspectors with proof of current registration.

With the old 121.5 MHz frequency beacons, approximately 98% of the distress alerts detected in Australia were false alarms. False alerts can be resolved quickly with 406 MHz beacons as they transmit a digital signal that identifies the owner. AusSAR keeps a register of 406 MHz beacon users and can simply make a phone call to determine if there is a genuine emergency or not.

If there is a problem, a 406 MHz beacon will eliminate much of the guesswork in a search by telling AusSAR your name, address and the type of boat, aircraft or vehicle you are in.

It is important to dispose of old EPIRBs correctly. If these beacons are discarded in rubbish tips, they may be activated inadvertently. This may result in an expensive search to determine if there is someone in distress, potentially diverting rescue resources away from a genuine emergency.

Battery World has a disposal system for obsolete EPIRBs. Old beacons may be dropped into any Battery World store and they will ensure the units are disarmed safely and the components recycled responsibly.

You can ensure your lifejackets are compliant with the Australian standards by shopping for jackets bearing the compliance marks of accredited certification bodies.

Some international lifejackets are now also accepted as alternatives to Australian Standards. To obtain a list of all accepted lifejackets, go to the Maritime Safety Queensland website.

Lifejacket standards

For a lifejacket to comply with a particular standard, certain information required under that standard must be displayed.

The current standard for lifejackets is Australian Standard 4758 (AS 4758). This standard has replaced Australian Standard 1512–1996, Australian Standard 1499–1996 and Australian Standard 2260–1996. You do not have to upgrade your current lifejacket under the old standards – they will still be acceptable for use as long as they are in good condition.

AS 4758 has a different rating system than the previous standards.

Here is how they compare:

	Under standard AS 4758
Coastal life jacket	Level 275
	Level 150
PFD type 1	Level 275
	Level 150
	Level 100
PFD type 2	Level 50
PFD type 3	Level 50 special purpose

Activation

Store EPIRBs in an accessible place, away from gear and passengers.

406 MHz EPIRBs come in two different types. One requires manual activation, the other will automatically activate when submerged in water. To activate manually, the antenna must be vertical. The on button is protected by a sliding door, which is fitted with a tamper seal. After three minutes a red light will flash, indicating the EPIRB is transmitting. It should have a clear view to the sky to maximise its signal. Those that activate automatically can also be activated manually and can be used if the ship is in imminent danger but is not sinking.

EPIRBs should be used only as a last resort. First use other communications or signaling equipment, such as marine radio, flares, V-sheet and mobile phone.

Rescue authorities respond to about 7000 activations each year and each one initiates a response. If you accidentally activate an EPIRB, switch it off and call the Rescue Coordination Section on 1800 641 792. If you are out to sea, please advise the police or the local volunteer marine rescue organisation.

Battery replacement

EPIRBs batteries have expiry dates, which should be shown clearly both on the battery and the outside of the beacon.

If your EPIRB's battery is past or near this date, have the unit serviced and the battery replaced by the manufacturer.

When disposing of an EPIRB for any reason, care should be taken to disable the device. Remove the battery so that no inadvertent alarms are raised.



Personal EPIRBs

Personal EPIRBs are designed to be hand held or secured in the pocket of a life jacket, but should not be considered a replacement for EPIRBs required by law.



Approved EPIRBs are designed to float in an upright position once they are in the water. They are physically larger and have ballast at the bottom. Most have a length of cord so it can float beside you. Floating upright causes the aerial to point directly upwards, ensuring easy detection by satellites or rescue craft.

Unless someone physically holds a personal EPIRB or puts it in a pocket, it will tip on its side when in the water, significantly reducing the chance of the signal being detected.

Holding personal EPIRBs by hand can become almost impossible after several hours in the water due to cold and exhaustion, and most life jackets do not have pockets for EPIRBs.

Both types of EPIRBs can have similar battery life and signal strength, but in the event of an emergency, approved EPIRBs are required by law for good reason.

Flares and smoke signals

Flares and smoke signals indicate assistance is required and show your location to a search craft. Use flares when there are other boats or aircraft in the area.

Flares and smoke signals should always be stored in a waterproof container, in a place where they don't receive too much pounding in rough conditions, away from heat sources and readily accessible.



Red hand flare—can be seen up to 6 nm away (10 km).



Orange smoke signal—visible in daytime only up to 2 nm away (about 4 km) on a clear day.

Some flares have raised shapes on the caps so they can be differentiated from each other at night.

To use, take the cap off from both ends, hold flare and use the striker to ignite the flare at the top end. Hold the flare downwind and away from passengers. When finished, dip the flare in the ocean to cool down, as they become very hot.

Flare disposal

Only flares and smoke signals that are within the manufacturer's expiry date can be considered as part of the safety equipment complement for your boat. You can dispose of flares and smoke signals that have passed the manufacturer's expiry date at various locations throughout the state, listed on the Maritime Safety Queensland website.

There are severe penalties for misuse of flares and smoke signals and any offender may also face the costs of labour undertaken, risk incurred, or loss sustained in consequence of the signals.

V-sheet

The V-sheet is a fluorescent orange-red coloured sheet with a large black V printed in the middle. It can be spread over the deck of a boat (or it can be flown as a flag) to indicate distress to searching aircraft and boats that assistance is required. It can also be spread over the hull of a smaller upturned boat and tied to the rails or fittings.



Signalling devices

Signalling devices include a torch, fluorescent light, lantern or cyalume sticks as long as they generate enough light to be seen by other boats and prevent a collision and attract attention. Fluorescent light sticks can be used to generate enough light to attract attention at close range. A buoyant waterproof torch is also valuable for working around the boat at night. Spare bulbs and batteries should be carried.

These signalling devices are not a substitutes for navigation lights. All boats under power should display navigation light(s) at night in accordance with the collision regulations (see page 59).

Marine radio

Marine radios are your lifeline to the shore. They enable you to advise volunteer marine rescue groups of your itinerary, receive weather reports, navigational warnings and most importantly, advise others that you need help. There are three types of radio – 27 MHz, VHF and MH/HF.

Dye markers

Dye marker packs should be attached to flag markers or lifebuoys. They can be opened to create a highly visible yellow stain in the surrounding water. Dye markers are effective by day only. The stain tends to disperse and loses visibility after about 20 minutes.

Other equipment

Depending on the size and type of boat, you may need the following equipment:

Navigation

To navigate you require a chart, compass and a watch. The distance travelled will depend on how fast you are going— $1 \text{ kn} = 1 \text{ nm/hr}$.

Marine charts give detailed information including depths, tides, navigation hazards and anchorages. They are essential when operating in unfamiliar areas or offshore. It is advisable to carry the appropriate chart of the area you will be navigating and to seek advice on local conditions.

With a chart and a compass you can determine your position (of particular importance in identifying your position to rescue craft in an emergency) and find a course back to shore if rain, fog, sea haze or smog obliterate the land from view. Rain, in particular, can easily limit vision to less than 500 m and without a compass it is very easy to become completely lost.



Charts are available through marine chandleries and the Maritime Safety Queensland website. Offshore charts (AUS series) are produced by the Australian Hydrographic Office and are available from chart agencies. The *Beacon to Beacon Directory* provides maps from Tweed Heads to Yeppoon.

Global Positioning Systems (GPS) give an instant latitude and longitude position. GPS technology is ever improving, however, it runs from a battery so never totally rely on electronics. Always carry a chart and compass as backup.

Tidal ranges in some locations can be extreme—your launching spot in the morning could be high and dry when you return in the afternoon. Take tides into consideration when planning your fuel needs and course. Tide details are given on the news, listed in newspapers, on the internet and there are specialised publications like the *Queensland Tide Tables*.

A depth sounder is a useful aid when approaching an anchorage or confirming chart details.

Anchor

Anchors are important safety equipment. Even if you do not plan to use them, anchors are imperative if a boat breaks down as it will keep the boat in the one position or reduce the rate of drift.

The size, weight and design of the anchor should suit your boat. There are five common types of anchors that are used for different purposes: Danforth, plough, reef anchors, drogues and sea anchors. Marine dealers will know the most suitable type and will recommend the length of chain and line.

Regularly check the condition of the chain, shackles and rope. Anchors should be stowed in an easily accessible location with the end of the rope fastened to the boat. Keep the rope neat and tangle-free. Ensure the anchor is very secure while under way.

Fire fighting equipment

Every boat with fuel aboard should carry at least one dry-powder fire extinguisher, mounted in an easily accessible and dry position. Check the fill gauge and shake regularly to stop the powder compacting. Remember, all gear used on boats is subject to corrosion and can deteriorate quickly—check regularly and spray with a water-repellent anti-corrosion agent.



Fire blankets and a strong bucket (with a 2 m lanyard attached) will also help douse a fire.

Fire blankets and extinguishers should be purchased from an authorised dealer who will be able to determine the best type for your needs. Fire extinguishers should be serviced and/or replaced at regular intervals. Storing smaller fire extinguishers in plastic bags will help protect them from salt water.

Bailing equipment

Taking on water increases the risk of swamping or capsizing, requiring a method of emptying the boat quickly and efficiently. A simple bailer—a bucket on the end of a rope tied to the boat—is fine for a small boat. Some people make their own, cutting a section from a plastic container (for example, a 2L milk container), giving a handle and a square base that scoops water more efficiently than a round bucket. A sponge may also be handy for small amounts of water.

Bilge pumps are recommended for boats 5 m and over and range from manually operated to electric. A good hand-operated pump is an excellent addition to your gear list. Check its operation regularly, and keep it well maintained. The bilge pump should be protected by a strainer to prevent choking of the pump suction. Clean bilges reduce the possibility of blocked pumps.

Depending on the size of the ship, at least one solidly constructed metal or plastic bucket with 2 m of rope attached should be carried on any ship. As a safety item, it is useful for both bailing water out and fighting fires.

Check what you are dumping overboard - pollution carries heavy fines!

Oars and paddles



Boats under 6 m in length should carry oars or paddles in case of an emergency. If the boat has fittings for rowlocks carry correct length oars with rowlocks securely attached.

If not, the paddles should be big and strong enough to do the job.

Practise rowing with them to see how difficult it is. A small auxiliary engine with a separate fuel tank may be an alternative.

Liferafts

An inflatable liferaft is recommended for larger boats proceeding to sea. They are the most efficient means of evacuating passengers and crew from a sinking boat.

They come in many sizes, some have provisions and lifesaving equipment and must be stowed in an accessible, quick-release housing.



Navigation lights

Navigation lights must be displayed on boats operating between sunset and sunrise and in restricted visibility. The types of lights required are determined by the boat type and their activity. They indicate the type and length of boat, the direction of travel or if they are anchored (see page 59).

First aid kit

Your kit should contain the basic requirements to cope with common injuries and be packaged in a sturdy, waterproof box. Someone aboard should have some first aid training.

Safety harness

Bluewater sailors need these items of safety equipment. Harnesses should be hooked on when working on deck or on watch and should always be worn at night.

Lifebuoy and throw line

Larger boats may carry one or more lifebuoys (or similar devices) stowed such that they can be quickly thrown overboard in an emergency, particularly when a person falls overboard. They may have attachments including lifebuoy lights and buoyant lines.



A device that may also be of similar use on a small boat is the rescue quoit on a long line attached to the boat. The quoit may be thrown to a person in the water or placed over the arm of a rescue swimmer.

Stow handy, ready for use—these items are useful extras for the well-equipped in-shore boat.

Fresh drinking water

Sufficient water should be carried for everyone on board for the duration of the trip. Extra should be taken in case of an emergency.

Sound signals

An efficient sound signal device like an air horn, can be used to indicate manoeuvres, attract attention and as a fog signal in restricted visibility.

Tool kit

As discussed in Section 2.4, every boat should have a tool kit containing tools and spare parts.

Care of equipment

All safety equipment must meet minimum standards, be in good working order and easily accessible.

Find a home for your gear where it is accessible and easily located during the day or night.

Safety equipment is generally durable and long-lasting. Keep small storable items like flares, V-sheet, EPIRB, torch and other bits and pieces in a sealed waterproof container.

2.9 Weather

Weather is important to safety. Always check and understand the weather before and during boating. If it looks dicey, don't go out—and if it starts to turn, head straight for shelter.

Learn to understand and read weather patterns. Know the wind and the boat's limits.



Sources of weather information

The Bureau of Meteorology issues regular forecasts for small boats operating in coastal waters including expected wind direction and strength, the state of the sea and swell, visibility, and changes expected during the forecast period.

Routine coastal waters forecasts and observations for particular areas within 60 nautical miles of the coast are updated several times daily. Coastal warnings are issued whenever strong winds, gales, storm-force or greater winds are expected, and renewed every six hours. You can access these by a range of methods including:

Broadcast band radio and television

A very useful start but not all these sources focus on the needs of mariners.

Marine radio

27 MHz marine radio

Most limited coast stations are run by volunteer marine rescue groups and provide weather schedules and/or weather information on request over 27 MHz (as well as VHF) marine radio. These stations could be contacted on channel 88 to determine local availability of weather information.

VHF marine radio

Bureau of Meteorology offices in Central and Northern Queensland issue coastal waters warnings, forecasts and observations on VHF. Weather information is available on request through VHF Channel 67 at several locations. Check the Bureau of Meteorology's (BOM) website.

MF/HF Marine Radio

Warnings, forecasts and coastal and offshore weather observations are broadcast from VMC (Charleville) and VMW (Wiluna). Schedules and frequencies are advised on the BOM website.

Telephone

Maritime Safety Queensland's Maritime Weather Service provides weather information from the Bureau of Meteorology at the cost of a local phone call.

All of Queensland	1300 360 426
Marine warnings	1300 360 427
South-east Queensland	1300 360 428

Internet

A full range of weather information is available on the Bureau of Meteorology's website at www.bom.gov.au.

In summary

To get the best possible idea of the weather, put your trust in a combination of the latest professional and local advice, your own local knowledge, and a constant, critical observation of the sea and sky.

Types of weather information

Warnings

Any strong wind, gale, storm or tropical cyclone warnings applying to coastal waters.

Situation/synopsis

A description of the position and movements of highs, lows and frontal systems expected to affect coastal waters in the next 36 hour period.

Forecast

A general description of the expected weather in the forecast period and outlook including:

- wind strength and direction
- height and direction of sea waves and swell
- factors affecting visibility.

Station observations

Details of recorded conditions at various positions along the coast.

Note—in forecasting terminology:

- wind gusts may be up to 40% stronger than the average speed given
- some waves will be higher (up to twice the height) and some will be lower than the average heights given
- sea and swell forecasts do not take into account local influences on waves (currents, tidal flows, depths and coastal landforms).

Weather map (synoptic chart)

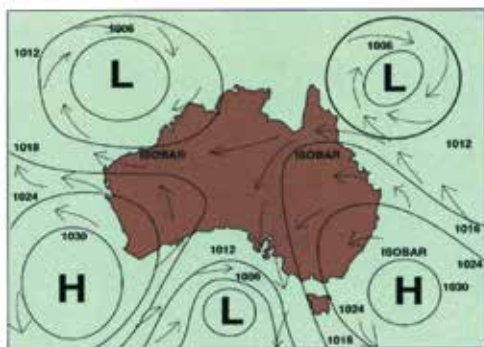

Winds are generated by differences in pressure within the atmosphere. Isobars (lines joining points of equal atmospheric pressure) on a weather map illustrate the pressure systems at sea level at a given time.

The pressure systems tend to move eastwards taking two to three days to cross Australia enabling a loose interpretation of the systems influencing the east coast in the day or two ahead.

A mariner can make judgements about wind strength and direction from a perusal of these charts.

Wind strength

Winds will tend to be strong where the isobar lines are close together (a steep pressure gradient).

Where they are widely spaced, winds will tend to be gentle.

Wind direction

Winds tend to blow out of a high pressure area and rotate anticlockwise around it and tend to produce stable fine conditions.

Winds tend to travel into a low pressure system and rotate clockwise around it and can produce unstable air with the chance of overcast, gusty and at times stormy conditions.

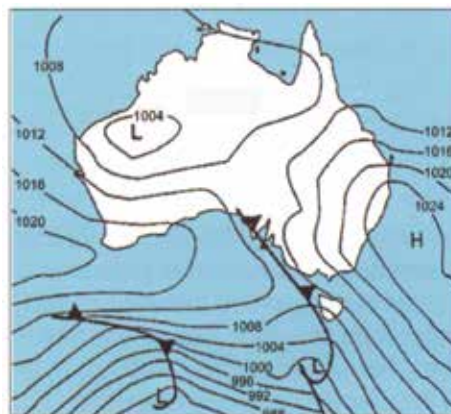

On this typical summer weather map, the east coast of Queensland would be experiencing light winds from the east/south east. Gulf waters would be essentially calm.

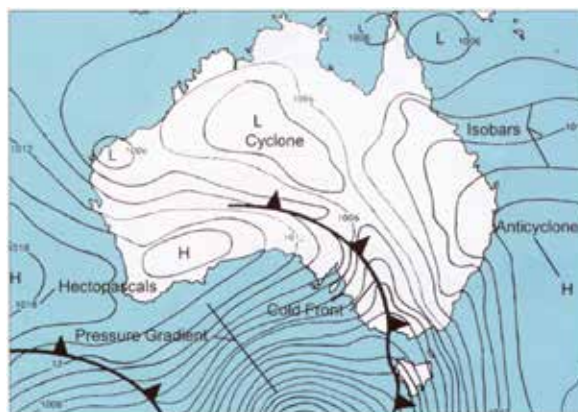

A cold front, such as that shown here moving across South Australia and Victoria, can produce a relative short period of extremely turbulent weather followed by a shift to stronger west/south westerly breezes. They are identifiable by a long band of dark clouds moving quickly from the south west and small boats should seek urgent shelter.

Further information on interpreting a weather map is available from www.bom.gov.au.

Local winds

The sea breeze / land breeze effects along the coast modify synoptic winds.

Land breeze (offshore)

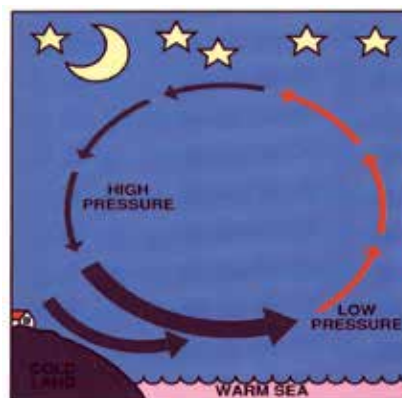

Because of the cooling of the land overnight, winds in the morning tend to be offshore and tend to produce better sea conditions. Be wary of overnight anchorages exposed to the west/south west.

Sea breeze (onshore)

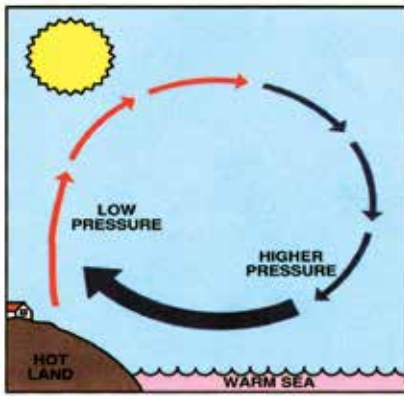

As the land heats up, winds tend to blow onshore in the afternoons and, particularly in summer, may become quite strong. This may also contribute in summer to the development of thunderstorms in late afternoon along the coast.

Winds and waves

To a large extent, wave action sets the performance limitations and capabilities of a small boat. This must be taken into account in buying a boat and, once bought, in selecting types of conditions and operational areas.

The Beaufort Scale

The Beaufort Scale is useful in providing a relationship between wind strength and sea state and wave height. The latter can present a considerable threat to small boats.

Sea waves are created by direct local action of wind on the sea. They have shorter wavelengths and periods than swell waves and are generally steeper. They are measured by length and height.

Swells are created by large weather disturbances operating at a distance. Though smooth and harmless looking, they travel very quickly and can create big breakers in shallowing water. Swell waves are long and smooth and are generally characterised by a wave period (time between consecutive wave crests) greater than 8 seconds.

Beaufort force	Mean winds		Explanatory titles	Open sea	Probable wave heights (metres)
	(km/h)	(knots)			
0	0	0	calm	mirror like	0
1	1–5	1–3	light air	ripples	0.1
2	6–11	4–6	light breeze	small wavelets	0.2–0.3
3	12–19	7–10	gentle breeze	large wavelets	0.6–1.0
4	20–28	10–16	moderate breeze	small waves	1.0–1.5
5	29–38	17–21	fresh breeze	moderate waves	2.0–2.5
6	39–49	22–27	strong breeze	large waves - rough	3.0–4.0
7	50–61	28–33	near gale	very rough - sea heaps up	4.0–5.5
8	62–74	34–40	gale	moderately high waves	5.5–7.0
9	75–88	41–47	strong gale	high waves - crests topple	9.0–12.5

A growing swell can indicate an approaching storm.

Swell is also measured by:

Length	<i>Short</i>	0–100 m
	<i>Average</i>	100–200 m
	<i>Long</i>	over 200 m
And height	<i>Low</i>	0–2 m
	<i>Moderate</i>	2–4 m
	<i>Heavy</i>	over 4 m

Sea waves caused by the local wind are often superimposed on swell moving in from a distance. Interaction between the two can cause unpredictably high waves and add to the dangers for mariners.

In addition to being determined by the strength of the wind, the height of waves also depends on:

- The time the wind has been blowing—conditions will deteriorate quite quickly over time in response to a steady wind (roughly double in size over a 12 hr duration). Take early action to seek shelter.
- The fetch—the further the winds travel across water, the larger the sea waves. Offshore breezes make for smaller waves than onshore breezes. In large bays, the waves will be smaller on the leeward shores (for example, near the south-east shoreline in a south-easterly breeze). Plan your boating areas to take advantage of this.

On the water

Conditions can change quickly and, in rapidly worsening weather, 2 km offshore can be just as dangerous as 20 km therefore:

- Regularly monitor available sources of weather information (marine radio, broadcast band radio and mobile phone can all be available afloat).
- Keep a constant lookout for signs of changing weather:
 - darkening and lowering clouds
 - whitecaps and changing sea state
 - falling barometer.
- Find out the local factors that influence sea conditions (including those on coastal bars).
- If whitecaps are visible offshore, stay in sheltered waters.
- Know where to reach shelter (protected shore, harbour or lee of an island) quickly and have alternative contingency plans.
- If winds are expected to pick up, plan to be upwind of your home shelter. Returning downwind will generally be easier and quicker.
- Be flexible—change your plans (destination and/or route) if necessary and tell whoever holds the voyage plan.
- If conditions deteriorate, put on life jackets.
- As the sea state develops, adjust boat handling to match conditions:
 - adjust course and speed to minimise water spray in the boat and stresses from pounding

- angle across waves to reduce the steepness of waves and limit pitching
- avoid surfing downwind.
- If necessary, ride out the initial onslaught of sudden, short-duration squalls by keeping the bow either directly into the wind and waves or slightly off their direction. The main criterion is to keep a speed sufficient to allow you to steer the boat, but no faster.
- Without power to maintain steerage, a boat will drift side on (beam on) to the sea. In big seas this is dangerous as the boat may easily capsize. A drogue tied onto a suitable rope to the bow will keep the boat pointing into the waves should the engine fail.
- Rough water may substantially increase your fuel consumption so carry extra fuel as a contingency.

2.10 Tides



Tides have a major impact on depths available and access for your boating activities and resulting tidal flows and offshore currents can substantially alter sea conditions.

Learn to consult tidal prediction tables and take into account their impact on boating.



Sources of tide information

Basic tide information is often broadcast on radio and television, included in newspapers and can usually be obtained on marine radio from limited coast stations. However, every boat operator should have available a current set of tide tables such as *Queensland Tide Tables* produced by Maritime Safety Queensland.

This publication provides the times and height of highs and lows for 28 primary ports in Queensland. It also provides conversion information to derive tides at about 250 additional secondary places along the coast.

Tide predictions

Although tides are influenced by astronomical and non-astronomical factors, local tides can be predicted with a high degree of accuracy from analysis of long-term tide records.

The tide predictions provide a forecast of the time and height of high and low water for a particular day at a particular place.

The height of the tide in metres and decimals is reckoned from the lowest astronomical tide. When a low water falls below datum, it is marked with a minus sign (-).

The range of the tide is the difference between the height of 'high water' and the next succeeding or last preceding 'low water'.

The rise of the tide is the height of high water above chart datum.

Causes of tides

Tides are the rising and falling of sea levels that result from the gravitational interaction and motion of the sun, the moon and the earth acting on ocean waters. Tidal patterns are influenced by the shape and depth of oceans and the weather. The combination of factors influencing local tides is complex and varies greatly from one site to another.

Along most of the Queensland coast, there are usually two high waters and two low waters in each day. Tidal ranges (height difference between high and low water levels) vary significantly from about 6 m around Mackay to about 1 m along the south coast and less than 2 m in Cairns.

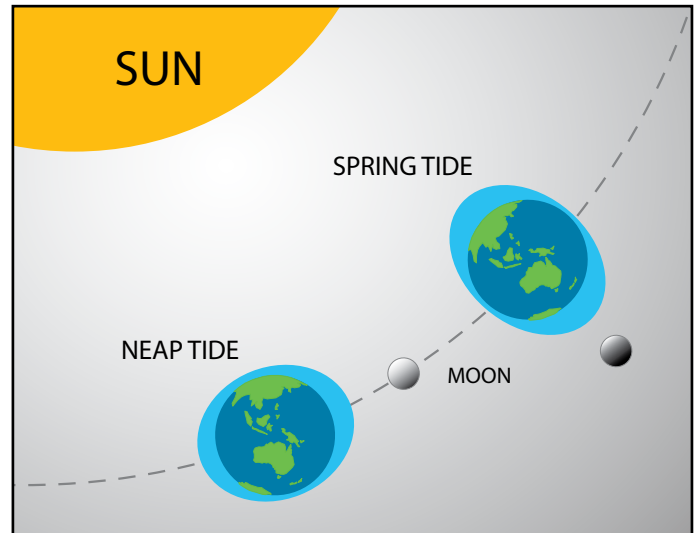

The moon orbiting the earth effects tide times and ranges. Tide times are almost an hour later each day.

During a full moon and new moon phase there is an increase in tidal range and water movement (spring tides). The high tides are very high and the low tides are very low.

During the first quarter and third quarter moon phase there is decreased tidal range and water movement (neap tides). The high tides are low and low tides are high.

Tide levels are measured from a reference water level known as chart datum (usually taken as the lowest astronomical tide [LAT]). This same datum is also used as the reference water level for the depth soundings (and drying heights) shown on most marine charts.

Hence, depth at any place will be a combination of the chart sounding plus the level of the tide.

Reading tide tables

Tide tables — like those shown below — provide detailed predictions of the times and heights of high and low waters at standard ports for every day of the year. The precise position is usually named and given a latitude and longitude. The time is given in the standard time for the area in a 24 hr clock. The depth of the tide is given in metres—the smaller number indicates low tide and the higher number indicates high tide (1).

MARCH				APRIL			
Time	m	Time	m	Time	m	Time	m
1	0543 0.22	16	0529 1.10	1	0028 5.74	16	0609 1.50
	1145 6.33		1126 5.28		0650 1.03		1151 4.41
WE	1819 0.29	TH	1745 1.01	SA	1239 4.87	SU	1800 1.15
			2345 5.03		1854 0.87		
2	0013 5.55	17	0556 1.26	2	0111 5.44	17	0016 5.16
	0626 0.45		1150 5.03		0737 1.50		0644 1.72
TH	1226 5.96	FR	1807 1.10	SU	1322 4.26	MO	1223 4.11
	1856 0.48				1930 1.34		1829 1.36
3	0056 5.45	18	0010 4.98	3	0200 5.06	18	0053 4.99
	0709 0.85		0623 1.49		0835 1.94		0728 1.95
FR	1306 5.40	SA	1214 4.72	MO	1420 3.71	TU	1306 3.80
	1932 0.80		1830 1.26		2017 1.84		1908 1.62

Secondary places (2) are those for which detailed predictions are not listed. The times and heights of high and low waters can be obtained by applying corrections to the predictions of a nearby standard port. These are listed in the back of the Queensland Tide Tables.

To calculate the time, add or subtract the time difference (3) as given in the tide table for the required secondary port to the predicted time of high and low tide for the standard port. The time variations are found in columns 1 and 2.

To calculate the height of the high or low water, multiply that of the standard port by the ratio listed in column 9 (4) then add or subtract (+ or -) the figure in column 10 (5).

Watching the tides

Tidal ranges in some locations can be extreme—the morning launching spot could be high and dry in the afternoon.

Bar crossings

Tides (height and direction of flow) can impact heavily on the state of the waves in coastal bars. Most bars are at their safest before high tide when the flow is still inwards (flooding) and depths are towards their greatest. The peak ebb flow (midway between high and the next low) will generally produce the worst conditions. More information on bar crossings is on page 64.



Fuel consumption

Local tidal effects such as wind against tide or tidal races in narrow channels can create hazardous sea conditions. Pushing hard against an unfavourable tide slows speed and increases fuel consumption.

Course planning

Tidal rips, overfalls, and the speed and direction of tidal streams and offshore currents are indicated on charts.

Overhead clearances

On Maritime Safety Queensland charts, overhead clearances are generally given above a water level known as Highest Astronomical Tide (HAT). In the case of electrical power lines, an additional safety margin is built in.

Note:

- the point of maximum clearance may not coincide with the deepest part of a channel
- clearance height may reduce during king tides or floods
- extra caution is required when launching/retrieving boats with a mast on shore—keep a lookout for overhead power lines.

Place	Semidiurnal Tidal Planes 2006										Ratio	Cons	HAT		
	Latitude		Longitude		Time Difference		MHWS	MHWN	MLWN	MLWS				AHD	MSL
	South	East	HW	LW	3	4									
Gold Coast Seaway	27	57	153	25	Standard Port	1.41	1.15	0.49	0.23	0.760	0.85	1.00	0.00	1.89	
North Coast New South Wales -															
Ballina (Richmond River)	28	52	153	35	+0.06 +0.06	1.4	1.1	0.5	0.2	0.79	0.86	1.00	0.00	1.9	
Brunswick Heads	28	32	153	37	+0.07 +0.07	1.5	1.2	0.5	0.2	0.86	0.75	1.00	0.00	2.0	
Kingscliff	28	16	153	35	+0.09 +0.09	1.3	1.1	0.4	0.2	0.75	0.86	1.00	0.00	1.9	
Tweed River Breakwater	28	10	153	33	-0.04 +0.00	1.46	1.24	0.65	0.41	0.86	0.86	0.92	+0.04	1.89	

In coastal areas, tides are accompanied by changing horizontal movements of water or tidal streams. Although there is interaction between the two phenomena, tidal streams are distinct from ocean currents.

Meteorological effects on tides

Meteorological conditions which differ from the average will cause corresponding differences between the predicted and the actual tide. Variations from predicted tide heights are mainly caused by unusually high or low barometric pressure or by strong prolonged winds. Low-pressure systems tend to raise sea levels and high-pressure systems tend to lower them. In general, it can be said that wind will raise the sea level in the direction towards which it is blowing.

Section 2 activities

Activity 1

A trip plan is important for a safe day on the water. Prepare a list of tasks in the table below under the headings 'what to do' and 'how to do it'.

What to do	How to do it
Example: tell someone where you are going	Leave a note on the fridge stating destination and estimated time of return and emergency contact numbers like Water Police.

Activity 2

Most boating incidents occur due to poor trip preparation. In the table below list problems or emergencies that could happen to you on the water. Also list the equipment you would need to have on board to prevent the situation.

Type of problem	Equipment to cope with problem
Example: engine breakdown—drifting towards rocks	An anchor to secure the boat, a V-sheet or flares to attract attention, a marine radio to call for help.

Activity 3

Should you refuel portable tanks on the boat?

Yes or no _____

Activity 4

Using the secondary port information on page 42, calculate the high and lows tides for Brunswick Heads on March 17th and 18th.

Activity 5

The preparation of your boat is of utmost importance; if you don't do your pre-departure checks it may let you down. List the main tasks and checks for your boat, its machinery and equipment before each boating trip.

Activity 6

Routine maintenance must be carried out on a regular basis. List the tasks you would perform on the following areas of your boat.

Hull _____

Engine _____

Steering _____

Controls _____

Electrical _____

Batteries _____

Fuel system _____

Safety gear _____

Activity 7

All good boaters will carry a tool box and spares on board. Make a list of tools and spares you think you would carry on your boat.

3.1 Factors influencing manoeuvring

As in all operations, the handling of boats in close quarters varies depending on:

- external factors
 - wind strength and direction
 - tidal flow strength and direction
- the characteristics of the boat
 - underwater profile
 - windage
 - displacement and shape
 - inboard or outboard engines
 - single-screw or twin-screw
 - the size and configuration of the rudder(s)
 - the size and efficiency of the propeller(s).

However, there are several common factors influencing the success, or otherwise, of all close-quarter operations. The impact of each of the following influences must be thoroughly understood, bearing in mind that they may interact with each other differently in varying conditions.

Wind

Wind can move a boat forcibly and it makes a major difference to mooring and close-quarter tactics as to whether the wind is 'blowing you on' or 'keeping you off'.

However, of often greater importance is the turning effect the wind imposes on a boat. Most (not all) boats tend to drop their bows away from the wind when stationary or almost stationary. When going astern at slow speeds, most sterns tend to seek the wind. The uneven distribution of windage above the waterline and lateral resistance below it cause these effects. Many small boats have greater windage and less lateral resistance (less boat in the water) in the forward sections.

The third effect of wind is leeway—the angle between the boat's heading and its track through the water. This effect is at its greatest at slow speed and helm offsets may have to be made in close-quarter manoeuvring.

Tidal flows

The entire body of water in which the boat is floating moves because of tidal flow. The boat, accordingly, will be moved with the flow and adjustments will be necessary to counter this.

This flow will also affect stopping (and starting) distances in relation to fixed objects such as docks, jetties, mooring buoys and poles. It is much easier to bring a boat to a stop next to a fixed object when the tidal flow is counter to a boat's heading.

When inboard engine boats manoeuvre against the tide (stemming the tide), rudder efficiency is increased as it needs a flow across it to operate effectively. When stemming the tide, the rudder will experience a flow across it and steerage will be maintained, even when the boat is stationary in relation to a fixed object. With the tidal flow coming from astern, steerage will be lost as soon as the boat is moving at the same speed as the flow. This is a lesser issue for steerage systems not relying on a rudder (for example, outboard propulsion).

A strong tidal flow can also assist close-quarter manoeuvring in terms of a sheer effect on the hull (and rudder) and is used to help move a boat sideways.

Transverse thrust

The force from a propeller driving a boat forwards or backwards is known as 'axial thrust'. Transverse thrust is a sideways force that is also generated by the action of a propeller and is commonly known as 'paddlewheel effect'.

Most propellers are 'right-handed' meaning they rotate clockwise in forward gear when viewed from astern. Such propellers tend to paddle the stern to starboard when going ahead and to port when going astern. The bow will appear to be tending in the opposite direction. 'Left handed' propellers will move the stern (and bow) in the opposite directions.

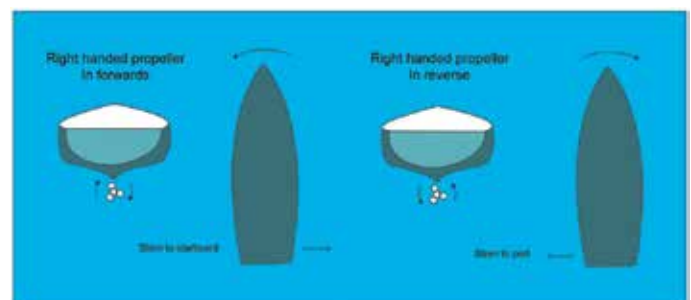

When moving ahead, transverse thrust will not be a major consideration as the rudder, across which the propeller is throwing a stream of water (axial thrust), will generally override it. In reverse, particularly at slow speeds, the rudder does not have a propeller-induced stream flowing across it and transverse thrust may dominate the steering effect. When operating in reverse, there may be no point in trying to counter transverse thrust with the rudder until the boat has significant 'way on'.

Transverse thrust can be particularly useful in close quarters manoeuvring of single-screw boats but its direction and effect must be correctly anticipated. Remember to focus on its effect on the reverse segment of close quarters manoeuvres.

Examples of transverse thrust (single-screw, right-handed propeller):

- Turning circle (tactical diameter)

A boat with a right-handed propeller will have a smaller tactical diameter if the turn ahead is to port (transverse thrust tends to move stern to starboard).

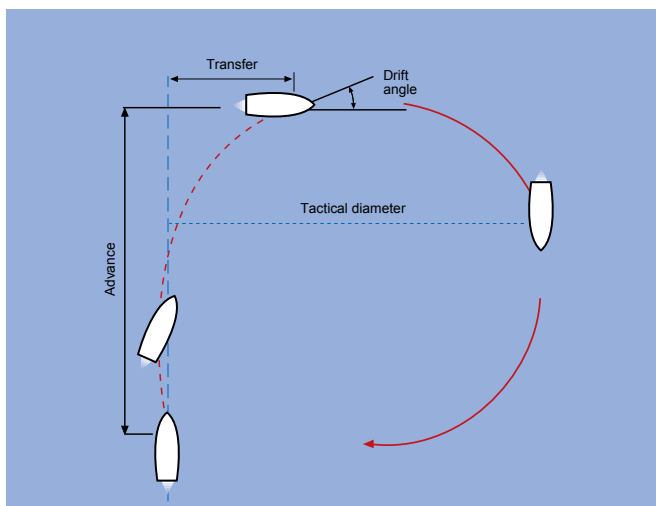

- Three-point turn

To gain maximum advantage of transverse thrust during the reverse leg of a three-point turn, the initial leg must be a turn to starboard.

Note: if the wind works against a three-point turn, dropping a bow anchor may assist.

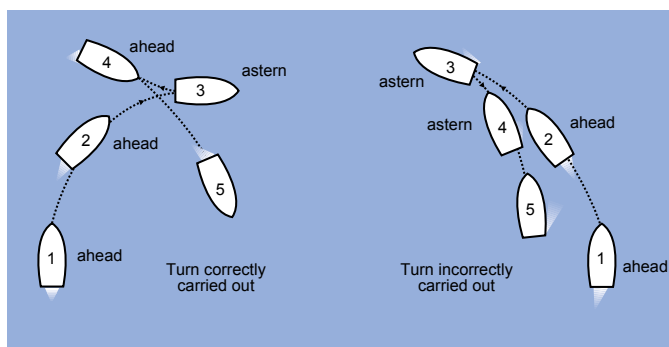

- Coming alongside

With a right-handed propeller, it will generally be easier to come alongside port side to. When a bow line is secured and reverse propulsion engages the stern will 'walk' in alongside.

- Picking up a mooring buoy

When approaching, keep the buoy marginally on the starboard bow because, when reverse is engaged to stop, the bow will tend to swing to starboard.

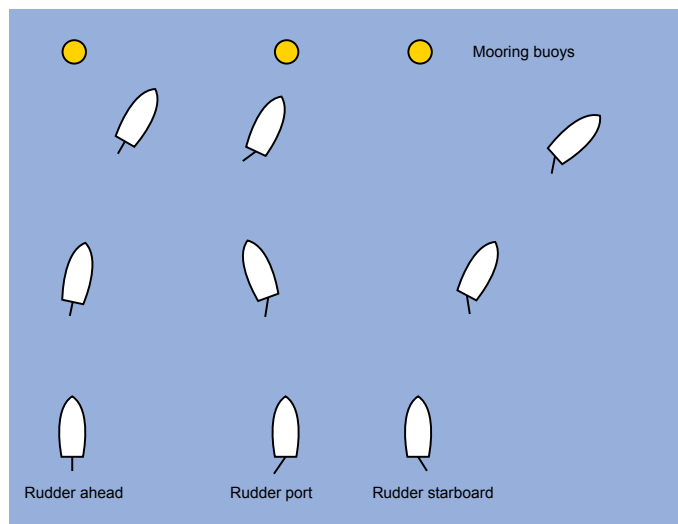

Twin-screw boats

Mostly on twin-screw boats the propellers will be counter-rotating with the starboard right-handed and the port left-handed. This ensures the transverse thrust effects work in with the intentions of canting engines (splitting one forwards, one reverse to turn around short). Outwards-rotating propellers allow the boat to turn very efficiently and they are generally easy to manoeuvre. Inward-rotating propellers result in a boat that is more difficult to turn short around but, used properly, may assist a boat to 'walk' sideways when needed.

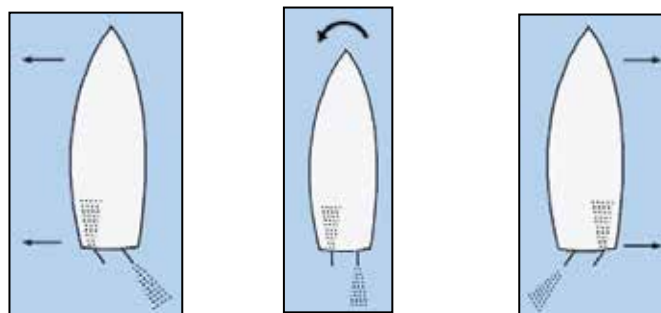

Pivot points

A boat is turned by shifting the stern sideways under the influence of a rudder (or, in the case of an outboard, by turning the direction of axial thrust). When going ahead, a boat has 'rear wheel steering' just like a forklift.

Because of this, the pivot point within the boat, and around which the boat turns, is located well forward of amidships. Three important considerations arise out of this for close-quarter manoeuvring.

1. The bow cannot be turned unless there is room for the stern to move in the opposite direction. (It is usually not feasible, for example, to steer a boat forwards away from a dock.)
2. To move the bow sideways will require a much larger movement of the stern in the opposite direction. For example, there is often insufficient stern room to correct a misplaced bow when entering a confined berth.
3. When turning in forwards, the stern of a boat will swing much more widely than the bow.

In reverse, the pivot point is usually slightly aft of amidships. Because of this, the bow will follow the stern quite well in reverse and it may often be easier to 'reverse park' in tight situations.

Lags in helm and throttle response

A boat does not respond instantly to the wheel or throttles—rather they give instructions that will be followed after a lag. The duration of these lags will vary among different boats and they need to be anticipated in close-quarter manoeuvres.

The lag in helm response is known as 'advance'—a segment of a turn in which a boat travels forward after a helm instruction and before the boat moves off its course line.

Practise steering manoeuvres at idling speed to understand the handling characteristics in different conditions.

3.2 Launching and retrieving

Launching

A systematic approach will enable successful launching of a small boat from a trailer. Courtesy to other ramp users is fundamental.

1. Most preparations should be undertaken prior to launching—not at the ramp:
 - putting the bungs in
 - checking all safety gear
 - checking the state of the batteries
 - checking fuel and oil.

Before backing the boat down the ramp:

- remove tie-down straps and trailer lights (disconnect trailer wiring)
- secure lines to bow and stern to control the boat when it floats clear of the trailer
- if launching a trailer-sailer, check for overhead wires before rigging or moving the boat
- rig any remaining gear such as radio aerial or transom-mounted echo sounder transducers.

Always walk carefully down a boat ramp you've never tried before—it may drop off or be slippery.

2. Drive to the ramp and back the boat and trailer down the ramp. Practice should be conducted in quiet carparks or home driveways, not at a busy boat ramp. If boating from various launching sites, it is worthwhile attaching a towball to the front of the vehicle.
3. Back in far enough to float the stern, but try to keep the tow vehicle's wheels out of the water. The distance the boat is backed into the water will depend on the incline of the beach or ramp. If the trailer is of the 'break-back' type you will not need to back it in as far as other trailers, but ensure there is enough water for the boat to float in as it is pushed off the rollers at a steeper angle.

4. Make sure you have attached a bow line to the boat, then release the winch and disconnect the winch line while holding onto the bow line. Launch the boat slowly.
5. Move the boat to an area away from the ramp to load additional equipment and passengers.

It's easy to forget the bung—but if you do, don't panic. Get the boat going and when it is moving fast enough, the water will drain away, and the bung can then be put in by one of the crew.

Remember the speed limit within 30 m of a boat ramp is 6 knots.

Retrieving



The steps for retrieving the boat are essentially the reverse of launching:

- Back the trailer into the water, again keeping the tyres of the tow vehicle at the water edge, not in the water. Pull out the winch cable and hook to the rear of the trailer.
- Manoeuvre the boat carefully onto the submerged trailer (ropes secured at both ends let the crew hold the boat aligned), attach the winch cable and shut off the engine prior to raising it.
- Winch the boat onto the trailer and secure it.
- Drive the trailer and boat out of the ramp for cleanup, reloading, securing equipment and safety check.
- Remove the drain plug to allow water to drain from the bilge.

There is a variety of trailer products on the market to assist in launching and retrieving. See your local marine dealer.

3.3 Berthing and unberthing

Manoeuvring alongside jetties and other boats in a seaman-like fashion avoids potential damage.

Tied up alongside

A small boat may need only a bow line and a stern line to be securely tied up alongside a jetty or pontoon. If the berth is not floating, these lines will have to be lengthened to allow for the rise and fall of the tide.

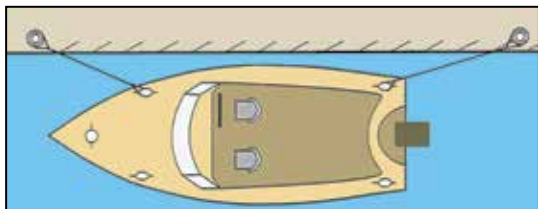

A larger boat should add a bow spring (runs aft from the bow of the boat) and a stern spring (runs forward from the stern of the boat) to ensure its security.

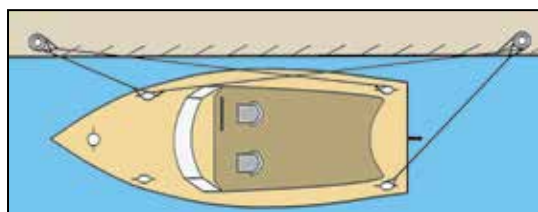

Leaving a jetty or pontoon

Because of the nature of boat steerage, it is not reasonable to drive ahead and steer away from a berth. To get the bow out, the stern must have room to move in.

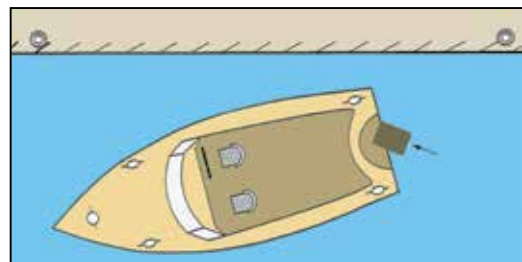

A very small boat may be manually pushed away from the berth after forward and aft lines are let go. Provided the boat moves well clear, it could then be driven ahead and slowly steered away from the berth. This may not be possible when the wind or tidal flow is keeping the boat on its berth.

An outboard engine boat can (generally) more easily reverse away from a berth. Forward is not engaged until the boat is well away from its berth.

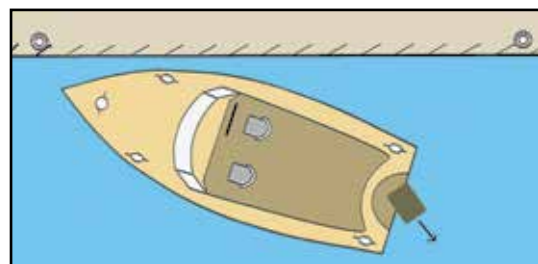

This relies on being able to redirect the reverse thrust of the outboard, an option not available on an inboard engine boat.

The optimum methods for inboard boats to leave the berth involve the use of spring lines where the berth bollards are temporarily doubled up so they can be recovered on board as the boat departs. Two methods of doing this are shown below.

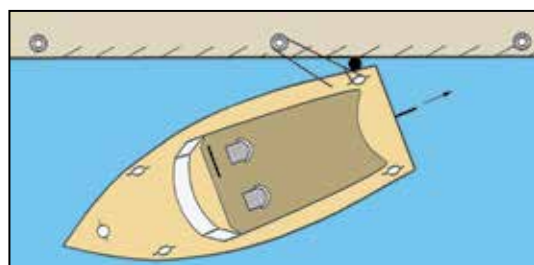
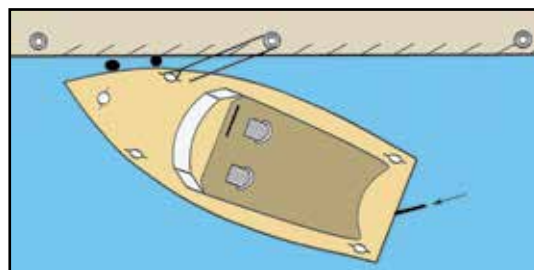

The better method will be influenced by the nature of the boat (ease of using fenders, overhangs forward and so forth) and the prevailing conditions of wind and tidal flow. These methods will also work effectively on outboard engine boats.

Coming alongside a jetty or pontoon

Where possible, a small boat may approach the berth at a fine angle, stopping alongside a dock bollard and placing a stern line on the bollard. By driving gently ahead the boat will be drawn alongside the berth and can be held there while other lines are secured.

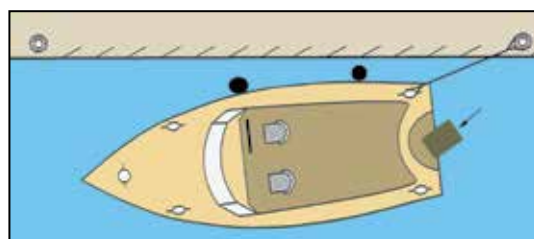

If the wind is blowing strongly off the berth, the boat may need to reverse into the bollard to secure the stern line and then motor ahead.

An alternative, suitable for inboard and outboard engine boats, is to approach the berth at a slightly broader angle and attach a bow spring. By gentle motoring ahead, using rudder or outboard to bring the stern in, the boat will seek the dock and remain alongside while other lines are secured.

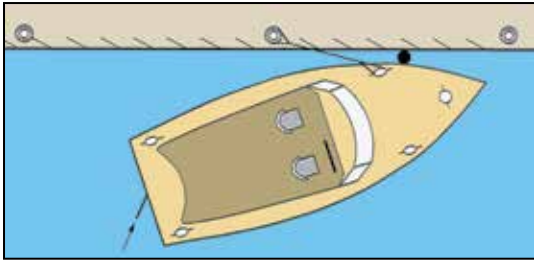

A third technique is favoured for inboard engine boats. After attaching a bow line, reverse propulsion uses transverse thrust of the prop to bring the stern alongside. Assuming a right-handed propeller, port side alongside will be favoured for berthing using this technique.

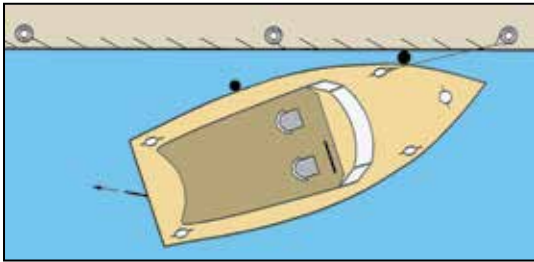

Skippers should avoid, as far as practicable, travelling in the same direction as a tidal stream or current when approaching a berth. This requires not only headway to be checked, but also sternway to be gained against the flow.

Berthing head to stream enables steerageway to be maintained and the tidal flow to be used to advantage in checking relative headway.

Twin engine boats

All the above manoeuvres can be achieved with twin-screw boats. Control during turning is enhanced by splitting engines (one forward and one in reverse). Remember to steer to the engine that is in forwards.

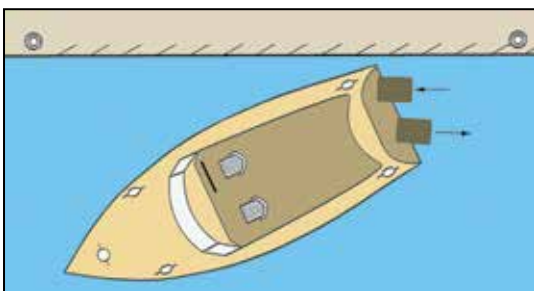

3.4 Attaching to a mooring

It might seem as simple as just grabbing or letting go a rope or two, but there's a right and wrong way to do it. Plan each step ahead.

To pick up a mooring:

- First observe other moored boats—their positions indicate wind and/or tidal flow. Different types of boats may lie in the opposite direction to the wind and current.
- The small pick-up buoy is also an indicator of drift direction.
- Approach from downwind or down-tide, using the stronger of the two as a brake.

- Come up slowly and don't over-run the mooring buoy—it risks fouling the propeller on mooring lines.
- Use a boat hook to capture the pick-up buoy. Secure line or chain to a bow cleat.

To leave a mooring:

- Warm up the engine and check for other boats nearby. If sailing, prepare the sails.
- If there is heavy strain on the mooring, use the motor or sails to come up to the mooring. Release the chain or rope from the bow cleat.
- Drift back to clear the buoy before moving away, avoiding lines in the water.

Note:

Most moorings belong to someone or are administered by a local agent/authority. Penalties apply for unauthorised use.



3.5 To anchor

An anchor is used when you want to stop and fish, swim, have lunch or stay overnight.

It is also an important item of safety equipment. Recommended requirements are highlighted in the minimum safety equipment table (page 25). Even if you do not plan to use it, an anchor is imperative if a boat breaks down. An anchor will keep the boat in the one location or reduce the rate of drift until help arrives.

When at anchor, remember changes in wind and sea conditions can affect the holding power of ground tackle, compromising the safety of the boat.

Anchors must be of a type that will work in the relevant seabed and with enough line to suit the depths in which you usually operate.

Other than for an emergency, boats must not anchor in channels, near navigation beacons or important notices on the shore such as cable crossing signs.

Types of anchors

There are types of anchors used for different applications:

A **Danforth** anchor is most commonly recommended for, and used by, small craft. The Danforth is a small light anchor with excellent holding power in mud and sand and can be easily handled in a small boat. Reefs should be avoided as the flukes may wedge in between rocks, causing the retrieval of the anchor to be difficult.



Danforth (sand)

CQR or plough anchors are the most commonly used by larger, heavier boats, but can be used in small craft. CQR or plough anchors also have good holding power in sand and mud but should not be used on reefs.

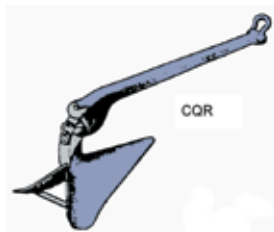

Reef or grapnel anchors are designed to hold on coral or rocks. Other types of anchors will lodge under coral and that's where they will remain. The prongs on a reef anchor are meant to straighten out when excessive load is applied and can then be bent back into position. They also create less damage to the coral.

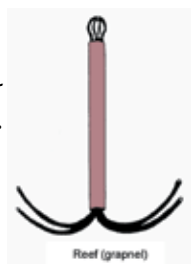

In coral reef areas it is better to anchor on sand where a Danforth or plough anchor is more suitable. Do not anchor on coral unless in an emergency.

A **sea anchor** or **drogue** is used in heavy seas to slow the drift and keep the bow of the boat into the wind and the waves. This will also provide more comfortable conditions when drifting in choppy seas.

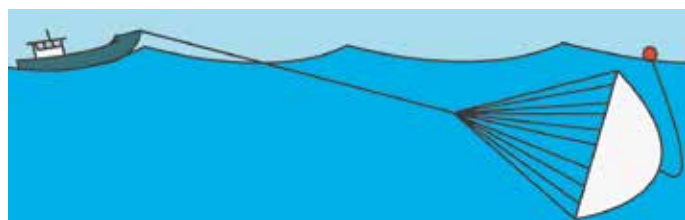

If you plan to go boating offshore or on an extended trip, a sea anchor is a valuable piece of equipment.

Anchor lines

Anchors also must have something to attach them to the boat. This is called the anchor rode and may consist of line, chain or a combination of both. The whole system of gear including anchor, rope and shackles is called ground tackle.

Anchor lines are important. Don't use an anchor line that floats such as a polypropylene. It can hinder the anchor from digging in and holding and is also prone to being cut off by boat propellers. Nylon and silver rope are both suitable material for anchor lines. Nylon is best known for its strength and stretching ability plus being more resistant to abrasion. Silver rope has less tensile strength.

There should always be a good length of chain (at least 2–3 metres) between the anchor and the anchor line. The purpose of the chain is to keep the stock or shank of the anchor parallel to the seabed that then allows the flukes of the anchor to gain maximum penetration into the seabed. The chain also helps prevent the anchor line chafing on the bottom. Generally the bigger the boat, the more chain you require.

The length of the anchor line may need to exceed five times the depth of water in which you normally operate. If you mark off the rope at regular intervals with coloured twine, you'll know how much rope to release so that the anchor sets correctly.

The scope

Scope means the ratio of the length of anchor line let out to the depth of water in the place you are anchoring.

It is essential to use the proper length of anchor line to hold the ship in all conditions. To calculate how much line to let out, allow for a ratio of 5 to 1. If conditions are extreme, increase the ratio to 8 to 1. The flatter the pull on the anchor, then the better it will hold. The ability of the anchor to hold the ship will also vary with the nature of the seabed.

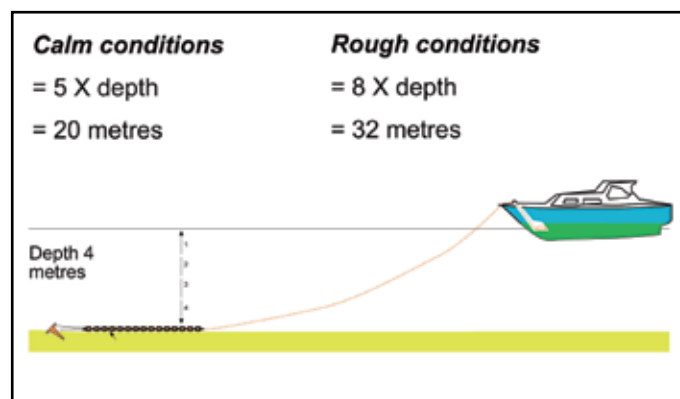

Anchoring

Keep the anchor, its chain and rope tidy—many boats have a chain locker or well. A plastic crate, bin or open bag keeps things neat. Leave the end out (or feed it through a hole in the crate or bin) to tie to the boat, then lay the rope down coil-by-coil, then the chain and anchor. Ensure the end is secured to the boat.

Charts or local knowledge will tell you where there is good holding ground—beware of submarine cables and other moorings.

When anchoring, lower the anchor to the bottom—don't pick a bundle of anchor chain and line and throw it over hoping it will untangle. Always lay your anchor line out—let it touch bottom and let the boat go astern until sufficient line is paid out.

Don't be tempted to anchor by the stern. Anchoring by the stern causes the stern of the ship to sit lower in the water. Any wave actions or even the wash of other ships can cause water to flow over the stern. Always anchor by the bow.

Ensure you take into account the rise and fall of the tide when selecting a long-stay anchorage.



Like anything else, there's a proper way to anchor:

- Select an area that offers maximum shelter from wind, current, boat traffic and so forth.



Be aware that the boat will swing downwind of current from the anchor.

- Consider how your boat will lie in relation to others. Pick a spot with swinging room in all directions.
- Determine depth and bottom conditions and calculate the amount of rope you will put out.
- Lay out the amount of rope you will need on deck in such a manner it will follow the anchor into the water smoothly without tangling. Ensure its end is secured to the boat.
- Motor slowly into the wind or tide to just ahead of your chosen spot.
- Wait until you start to drift backwards, then lower the anchor, checking the marks on the rope.
- When it touches bottom, slowly pay out the required scope (gentle reverse propulsion may assist), then secure the rope to a cleat.
- Motor gently back against the anchor to dig it in and ensure it is holding.
- While still in reverse, observe a transit between two fixed features to be sure the anchor isn't dragging. This can also be determined by observing the angle of the cable away from the boat and by placing fingers on top of the rope to feel for any vibration that would accompany the dragging of an anchor over the seabed.
- Check frequently to make sure you are not drifting.
- Don't forget to show the correct lights at night.



Raising the anchor

Warm up the engine and motor slowly along the line of the anchor rope, bringing in the rope and feeding it into the bin or locker. Don't over-run the rope.

In small boats always try to handle the anchor from the cockpit, not the foredeck.

When the boat is directly above the anchor, a good pull or, with the line secured on a cleat, a short push ahead under power should release it from the seabed. Once free, raise the anchor to the waterline. Clean if necessary and let the rope dry before stowing away.

If the anchor becomes caught, do not move the boat over the top of the anchor in an attempt to dislodge it as it may cause the boat to overturn. If you cannot dislodge the anchor, it is safest to cut it off.

A handy hint is to wear gloves when hauling in the anchor.

Section 3 activities

Activity 1

List some factors that affect the manoeuvring of a boat.

Activity 2

The diagrams below show two different windage situations. Out of the two which one would be easier to berth your boat alongside the jetty and why?

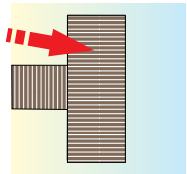

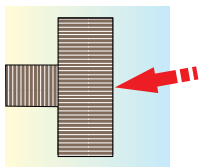

Activity 3

The diagrams below show two different tidal situations, out of the two which one would be easier to berth your boat alongside the jetty and why?

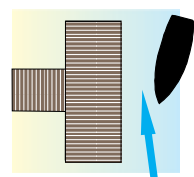

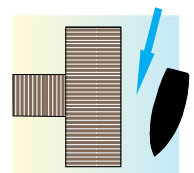

Activity 4

Propellers are either left or right handed, named by the direction they rotate in forward propulsion, in the following two pictures name the propellers.

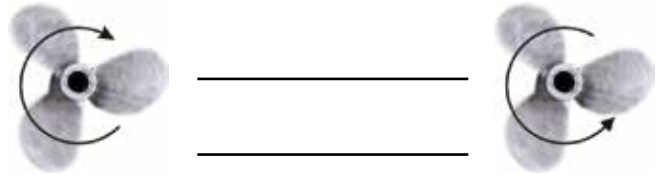

Activity 5

Transverse thrust has a tendency to walk the stern of your boat in a certain direction depending on whether your propeller is left or right-handed. Which way will the stern walk on these two boats when in reverse?

Right-handed

Left-handed

Activity 6

With a right-handed propeller, it would be easier to berth alongside a jetty with:

A port side to jetty

B starboard side to jetty

Activity 7

List the main steps involved in launching a boat from a trailer.

Activity 8

What considerations should be made before anchoring a boat?

Activity 9







If you wished to anchor in 10 m of water, how much anchor line should be used in average weather conditions?

4.1 International code of signals

Phonetic alphabet, morse code and signal flags (single letter signals)

May be made by any method of signalling.

For those marked* see note below.

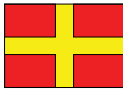
A ALPHA ..-		I have a diver down; keep well clear at slow speed.	O OSCAR - - - -		Man overboard.
B* BRAVO - - . . .		I am taking in, or discharging, or carrying dangerous goods.	P PAPA . - - - .		IN HARBOUR: About to sail. FISHING VESSELS AT SEA: Nets fast on an obstruction.
C* CHARLIE - - . . .		Yes (affirmative or "The significance of the previous group should be read in the affirmative").	Q QUEBEC - - - - .		My vessel is "Healthy" and I request free pratique.
D* DELTA - - .		Keep clear of me; I am manoeuvring with difficulty.	R ROMEO . - .		No single international meaning allocated.
E* ECHO . -		I am altering my course to starboard.	S* SIERRA . . .		My engines are going astern.
F FOXTROT . . . - .		I am disabled; communicate with me.	T* TANGO -		Keep clear of me; I am engaged in pair trawling.
G* GOLF - - . .		I require a pilot. FISHING VESSELS: I am hauling nets.	U UNIFORM . . -		You are running into danger.
H* HOTEL		I have a pilot on board.	V VICTOR . . . -		I require assistance.
I* INDIA . .		I am altering my course to port.	W WHISKEY . - - -		I require medical assistance.
J JULIETT . - - - -		I am on fire and have dangerous cargo on board; keep well clear of me.	X X-RAY - - . . .		Stop carrying out your intentions and watch for my signals.
K KILO - . .		I wish to communicate with you.	Y YANKEE - . . - -		I am dragging my anchor.
L LIMA . - . . .		You should stop your vessel instantly.	Z* ZULU - . .		I require a tug. FISHING VESSELS: I am shooting nets.
M MIKE - -		My vessel is stopped and making no way through the water.		An international distress signal.	
N NOVEMBER - .		No (negative or "The significance of the previous group should be read in the negative").		Proceed at slow speed when passing.	

Note: signals of letters marked * when made by sound may only be made in compliance with the requirements of Rules 34 and 35, excepting that sound signals 'G' and 'Z' may continue to be used by fishing vessels fishing in close proximity to other fishing vessels.

Multiple letter hoists

A great many messages can be sent by combining multiple hoists of code flags. For interpretation of multiple hoists, mariners generally need to consult the code of signals. Three important double letter hoists are given below:

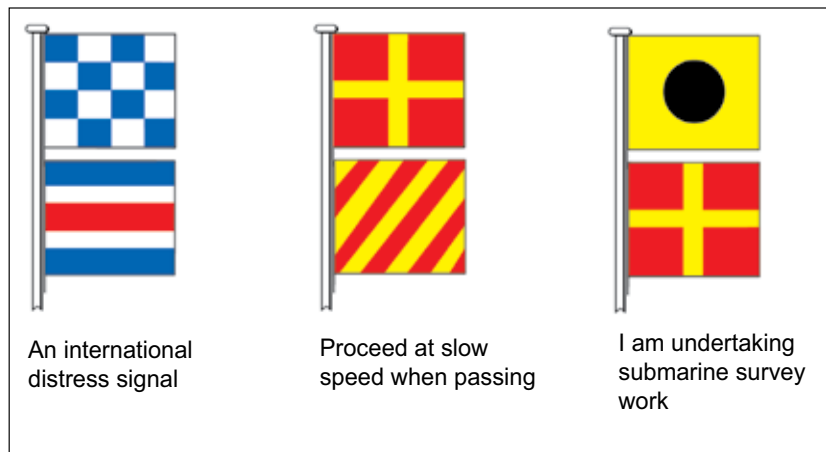

Number pennants

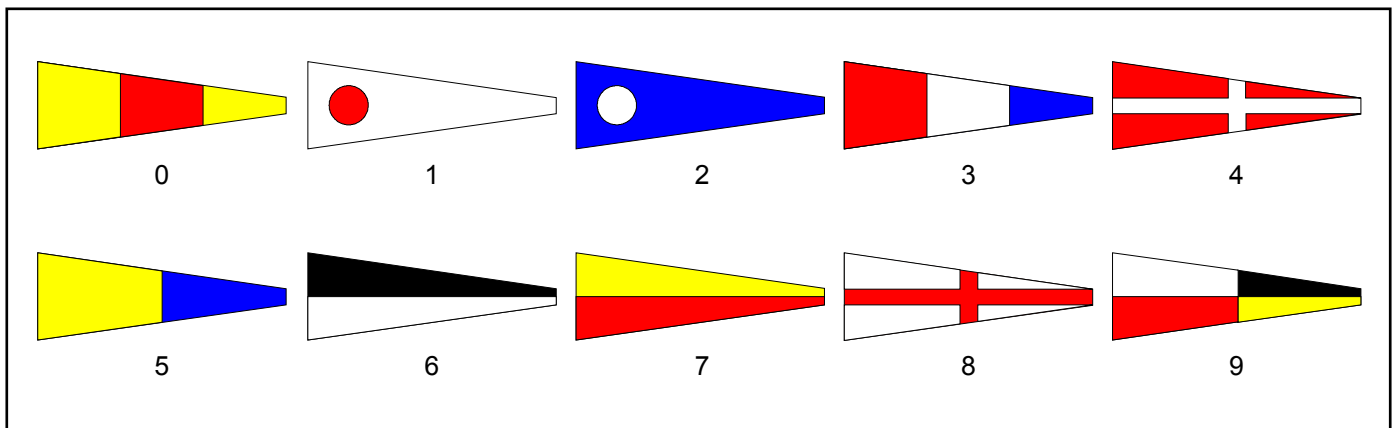

Substitute pennants

Substitutes are used to repeat an alphabetic or numeric pennant.

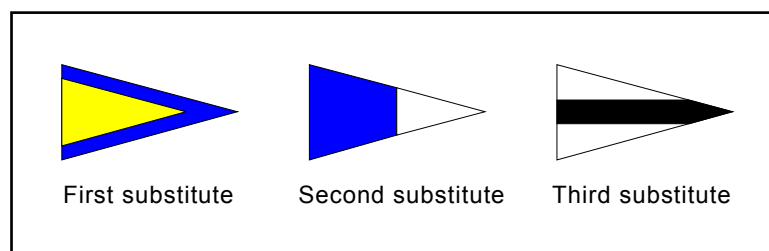

Code or answering pennant

This is used to tell the sender the message has been received and understood.

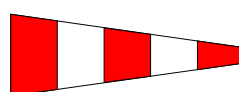

Queensland legislation

The IRPCS is brought into effect in Queensland by the *Transport Operations (Marine Safety) Act 1994* and *Regulation 2016*. The legislation also imposes special local Rules, the most notable of which relate to speed and wash limits.

4.2 IALA buoyage system

A system of buoys, marks and lights, known as the International Association of Marine Aids to Navigation and Lighthouse Authorities (IALA) Buoyage System 'A', is used to assist safe navigation. These are the equivalent of road signs on highways. Study a chart, as well as the buoys themselves, to familiarise yourself with their meanings.

Each type of mark has a unique combination of colour, shape, topmark and light. You must be able to recognise these and pass them safely on the correct side.

Lateral marks

Port and starboard marks are referred to as lateral marks. They indicate the port and starboard hand sides of navigable waters (channels).

When a port and starboard mark are placed near to each other, travel between them.

Often lateral marks are not placed in pairs where the safe side to pass is generally determined by the direction of travel to or from the sea.

STARBOARD

Lateral marks

When lit exhibits

Beacons

Buoys

Light sequence

Photo example

PORT

Lateral marks

When lit exhibits

Beacons

Buoys

Light sequence

Photo example

When going upstream (away from the sea):

- keep red (port hand marks) on the left-hand side (to port)
- keep green (starboard hand marks) on the right-hand side (to starboard).



When going downstream (towards the sea):

- keep red (port hand marks) on your right-hand side (to starboard)
- keep green (starboard hand marks) on your left-hand side (to port).



Local direction of buoyage

Where there is doubt, the direction of buoyage is indicated on charts by the symbol.

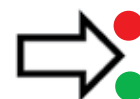

Light sequence

By night a port buoy shows a red light and a starboard buoy shows a green light. Any rhythm may be used.

Cardinal marks

A cardinal mark indicates where the safest water may be found and is used in conjunction with the compass. It may indicate the deepest water in the area, the safe side on which to pass a danger or may draw attention to a feature in a channel such as a bend, junction or an end of a shoal.

You should pass on the eastern side of an east cardinal mark, on the southern side of a south cardinal, on the western side of a west cardinal and on the northern side of a north cardinal.

CARDINAL MARKS

When lit exhibits.

Photo example

NORTH SOUTH EAST WEST

By day, the colour scheme can be remembered by noting that the black segment is positioned where the cones point:

- North—the top marks point up
- East—the top marks point outward
- South—top marks point down
- West—top marks point inwards.



Light sequence

Cardinal marks, when lighted, all display a white light. To aid memory, associate the number of flashes with a clock face: three flashes indicate east, six flashes indicate south, nine flashes indicate west, and 12 flashes indicate north. North flashes continually. To ensure that no confusion occurs between east, south and west cardinal marks, a long flash immediately follows the six flashes of the south mark.

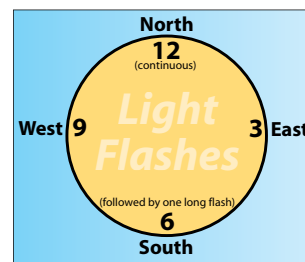

Special marks

This indicates a special area or feature such as traffic separation, spoil ground, cable or pipelines including outfall pipes and groynes. They can also define a channel within a channel, for example, a channel for deep draught boats in a wide estuary where the limits of the channel for normal navigation are marked by red and green lateral buoys.

They will also be found at the intersection of two channels where the use of a lateral or cardinal mark may not be appropriate.

As a general rule, consult a chart to see which side to pass.

Special marks can be used as lateral or safe water marks by using can, cone or sphere-shaped buoys.

SPECIAL MARKS

When lit exhibits

Light sequence

Photo examples

Light sequence

At night the light is yellow and the rhythm may be any other than those used for the white light of a cardinal, isolated danger and safe water marks.

Isolated danger mark

This indicates an isolated danger (for example rocks, reef, shoal or wreck) with navigable water all around it—but don't pass too close. The chart should be consulted to determine the extent of the danger.

ISOLATED DANGER MARK

When lit exhibits

Light sequence

Photo example

Light sequence

At night a white flashing light shows a group of two flashes. The characteristics may be best remembered by associating two flashes with two spheres as the topmarks.

Safe water mark

This mark indicates there is navigable water all round the mark, for example division of large shipping channels or landfall buoy. In Queensland, they are used to mark the seaward beginning of fairways entering major ports.

SAFE WATER MARK

When lit exhibits

Photo example

Light sequence

At night a white light shows a single long flash every 10 seconds.

Other navigation aids

Leads

Leads are often used to guide boats into a port or through sections of a waterway. It is essential to consult the chart for relevant leads and other navigation aids before entering unfamiliar waters.

Commonly they are triangular in shape, the front beacon having its apex upwards and the rear beacon inverted.

Many new leading beacons carry no top mark and can be distinguished by fixed white day lights.

At night, major leads are lit. Increasingly, blue is a favoured light colour for leads where there is a great deal of background lighting.

LEADS

Line of leads

Front lead

Back lead

Channel leads may exhibit a light of any colour

Photo example

Fixed blue lights are also commonly used to mark the centre of the channel on overhead bridges.

By moving your boat to a position so that both leads are lined up, you will generally be in the centre of the channel.



Given leads are usually in larger channels, open them up a little to starboard to keep to the side of the channel. Leads show the centre of the channel which is not consistent with the rule advising boats to travel as far to the starboard side of a channel as is safe and practicable. This is especially important at night.

IALA buoyage system in charts

The buoyage system is a silent traffic conducting system on the waterways 24 hours a day, 7 days a week. Before heading out, particularly on unfamiliar water, it is wise to prepare for your trip by studying relevant maps or charts to determine the best course to a destination, landmarks to look out for and any potential hazards to avoid. This requires a sound knowledge of the symbols used on charts to denote the IALA buoyage system.

The map below is taken from the Maritime Safety Queensland publication the *Beacon to Beacon Directory* and shows a stretch of water on the northern fringe of the Gold Coast. It shows a selection of navigation aids.

Please note, the map has been adapted for illustration purposes.

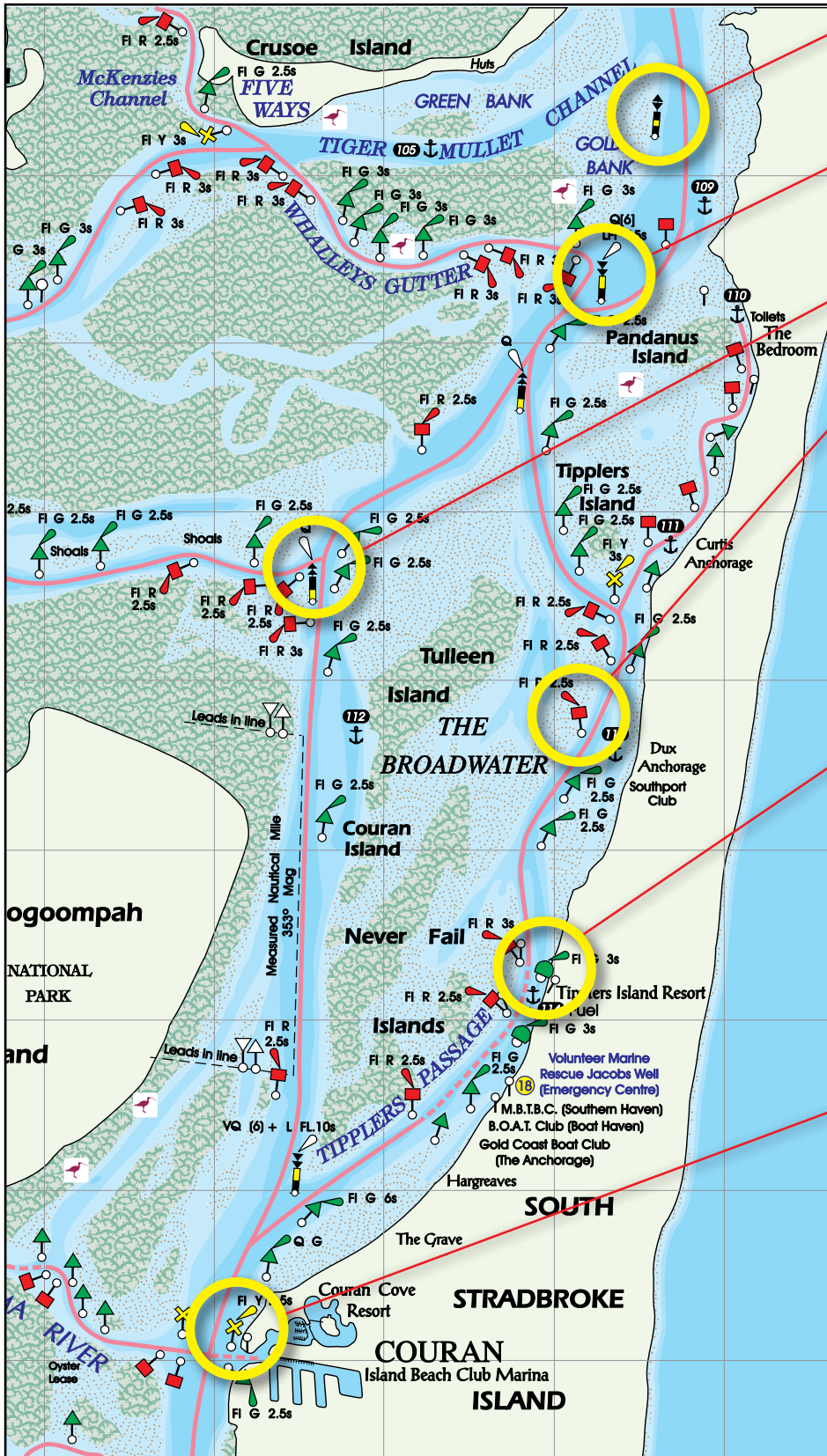

East cardinal mark: Indicates the end of a shoal and that the safest water is on the eastern side of the mark.

South cardinal mark: Indicates a bend in the channel and that the safest water is on the south side of the mark.

North cardinal mark: Indicates the end of a shoal and the safest water is to the north of the mark.

Port lateral mark: Indicates the navigable channel. When travelling upstream (away from sea) keep on the left-hand side. When travelling downstream, keep on the right-hand side. In this case, the Gold Coast Seaway to the south is regarded as the closest entry point to the sea, so therefore keep the port lateral marker to the left when travelling north.

Starboard lateral mark: Indicates the navigable channel. When travelling upstream (away from sea) keep on the right-hand side. When travelling downstream, keep on the left-hand side. In this case, the Gold Coast Seaway to the south is regarded as the closest entry point to the sea, so therefore keep the starboard lateral marker to the right when travelling north.

Special mark: A special mark can indicate several characteristics. In this case the mark is located at the intersection of two channels—the main channel through the broadwater and the channel leading to Couran Cove Resort. Only by consulting a chart or map can you accurately determine which side of the mark to pass. A special mark can also indicate the presence of a pipeline or groynne.

Directional and sector lights

Directional and sector lights are also installed to assist navigation in inshore waters.

A directional light may show only through a very small arc (less than 60°) and serves a similar purpose to leading lights.

Sector lights normally display arcs of different coloured lights in particular sectors to warn mariners of hazards and advise clear channels.



Advisory signs

Advisory signs are installed to advise on matters of importance to navigational safety including:

- Anchoring is prohibited.
- Submarine cable crossing—anchoring is prohibited within 200 m of submarine cables. If an anchor becomes snagged near one of these signs it should not be retrieved—cut the anchor line.
- Speed limits.



4.3 Rules of the road

The 'International Regulations for Preventing Collisions at Sea' (commonly referred to as the ColRegs) are the traffic laws of the sea. They give clear indication about passing, approaching, giving way and overtaking to avoid collisions with other boats. They apply equally to all boats afloat.

All boat operators must thoroughly understand and apply the rules in all situations.

Boat operators must do whatever is necessary to avoid a collision. Actions must be clear and deliberate so other operators can see your intentions. Never assume the skipper of another boat will observe the rules—always be prepared to take action to avoid a collision.

Significant penalties apply for failure to observe these rules.

Lookout

A good lookout, through sight and sound, must be kept at all times. Be aware of other boats, especially in bad weather, restricted visibility and in darkness.

Safe speed

Travel at a safe speed at which you can manoeuvre to avoid collisions. This will vary depending on prevailing conditions including visibility, traffic density, proximity to hazards, depth, manoeuvrability and background lighting.

Always keep a safe distance from other boats so you can stop or manoeuvre to avoid any sudden danger. The faster the speed, the greater the safe distance must be.

Assessing risk of collision and taking action

Use all means available to assess whether other boats pose a risk of collision. One early indicator is to see whether the bearing of a closing boat is virtually steady. If it is, a risk of collision exists and early positive action (changing course and/or speed) can be taken to eliminate the risk.

Channels

When navigating in narrow channels, all boats should travel on the starboard side or right hand side of the channel and pass oncoming boats on their port side.

If plenty of distance separates two passing boats, there is no need to deliberately alter course to pass to the right of the other boat. The rule is simply there to remove doubt in the event of a close situation.

Avoid anchoring in channels, especially near markers.

Small boats (including sailing boats) should keep clear of large boats that have limited room to manoeuvre in channels or are constrained by their draught.

Giving way

Power boats

Head on

When meeting head on, both boats are required to alter course to starboard (right), never to the port (left). Any turn should be large enough to be obvious to the other boat.

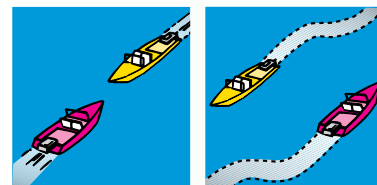

Crossing

When two boats are crossing, the boat on your right is the **stand-on** vessel. As the **give-way** vessel you should keep clear, alter course or slow down to pass astern of the other boat.

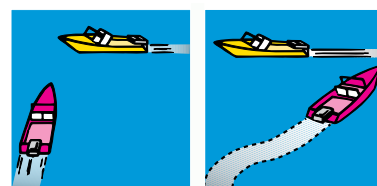

If you are the stand-on vessel, be predictable—keep your course and speed. If the other boat does not give way, you must take appropriate action to avoid a collision; bearing in mind this does not relieve the obligation of the other vessel to take action.

Overtaking

If you are overtaking a boat, you can do so to either side of the boat you wish to pass. However, you must keep well clear of the boat you are overtaking. This applies to both sail and power boats.

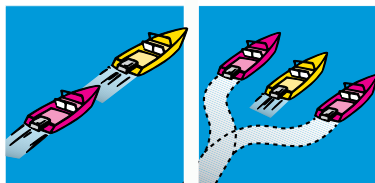

In narrow channels you must be particularly careful when overtaking. In all instances, make sure you do not cut in front of the boat you have overtaken.

Sailing boats

Wind on different sides

When each sailing boat has the wind on a different side, the boat with wind on the port side shall keep out of the way of the other.

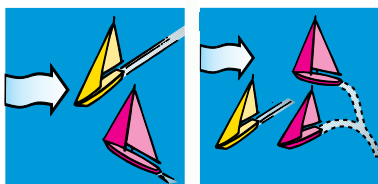

If a sailing boat with the wind on port side sees a sailing boat to windward and cannot determine with certainty whether the other sailing boat has the wind on the port or starboard side, it must keep out of the way.

Wind on the same sides

When both sailing boats have the wind on the same side, the boat to windward shall keep out of the way of the boat to leeward.

NOTE: The windward side is the side opposite to that on which the mainsail is carried or, in the case of a square rigged boat, the side opposite to that on which the largest fore and aft sail is carried.

Power and sail

A power boat generally gives way to sail unless the sailing boat is in the process of overtaking it.

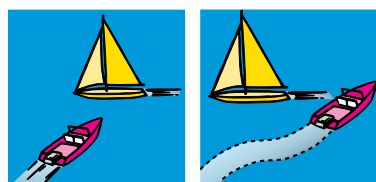

However, don't expect large, less manoeuvrable boats under power to give way. All small craft should give large boats a wide berth.

Special rights

Power-driven boats must give way to:

- sailing boats (except if they are large with limited manoeuvrability)
- boats engaged in commercial fishing and trawling
- large boats constrained by their draught in channels

- boats restricted in their ability to manoeuvre because of their work
- boats unable to manoeuvre because of exceptional circumstances (not under command).

These boats are recognisable during the day by their day marks and at night by their lights.

Diver below

This flag indicates the boat has a diver below. It should be placed to ensure all-round visibility. Reduce speed and remember you must not operate your boat within 30 m of a diver in the water if this flag is displayed.

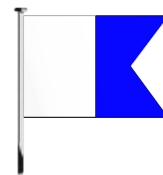

During night diving, a boat must show the international signal for a 'vessel restricted in its ability to manoeuvre'. These are three lights shown here.



Restricted visibility

Use common sense and slow your boat or stop, and be ready to take immediate action. Be extremely cautious when operating in restricted visibility.

4.4 Sound signals

Most recreational boats (under 12 m) do not use sound signals; however, larger boats use them. Be aware of signals and what action to take when sounded. Sound signals may be accompanied by light signals. The more common signals used are:

- one short blast—I am altering course to starboard (right)
- two short blasts—I am altering course to port (left)
- three short blasts—I am operating engines astern (reversing or stopping)
- five (or more) short blasts—I am alerting the other boat—I am unsure of your intentions.

These signals may be supplemented by light signals.

All boats should use sound fog signals in restricted visibility to alert others of their position. The most common fog signals, sounded at intervals not exceeding two minutes, include:

- one long blast—power boat under way, making way
- two long blasts—power boat under way, not making way through water
- one long, two short blasts—sailing, fishing, working boats making way.

If necessary to attract the attention of another boat use any light or sound signals which cannot be taken for any signal authorised elsewhere. Alternatively a white hand flare or a beam of light directed at the danger may be used. Do not shine a light directly into the eyes of another skipper.

4.5 Navigation lights

By law, boats operating from sunset to sunrise, whether at anchor or under way, must display the correct lighting. A boat is 'under way' when it is not at anchor, moored, made fast to the shore or aground.

Navigation lights must also be used in daylight hours during periods of restricted visibility or in other circumstances when it is deemed necessary.

Lights must be placed and displayed appropriate to the size and class of your boat. These lights tell other boat operators about the boat and what it is doing—whether it is at anchor, under sail or motoring.

Navigation lights must be positioned so they are not obscured by the boat's superstructure or interfered with by the deck lights. They should be fitted by the manufacturer or an authorised person.

The masthead and/or all round white light must be fitted (if practical) on the centre line (bow to stern) of the boat.

When operating at night, carry replacement bulbs.

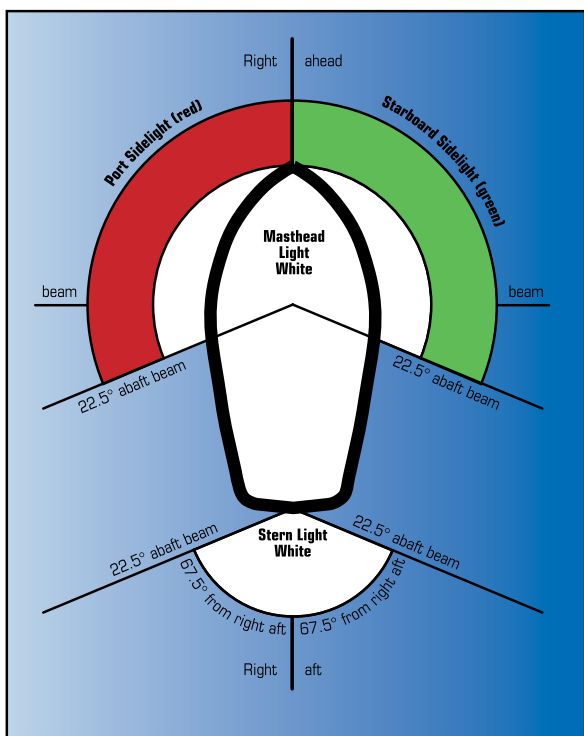

Minimum required lights

Boats under way

Power boats

- Less than 7 m in length with a maximum speed not exceeding 7 kn—a white light visible all round and, if possible, separate or combined sidelights.
- Less than 12 m in length:
 - a) separate or combined sidelights, a masthead light and a stern light or
 - b) separate or combined sidelights and an all round white light.
- Power boats more than 12 m in length but less than 20 m in length:
 - a) a masthead light, separate sidelights and stern light or
 - b) a masthead light, combined sidelights and stern light.

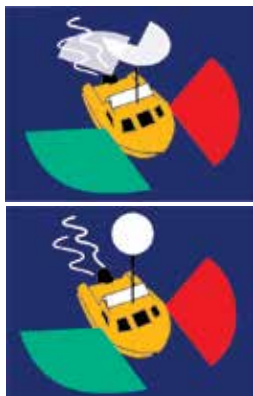

Note:

- Larger boats may have two masthead lights—the higher masthead light towards the stern.
- Boats drifting are still 'under way' and must show the same navigation lights as if they were still making way.

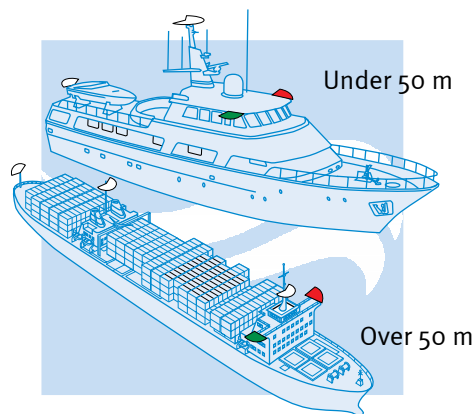

Sailing boats

- While being motor driven (even with sails up)—lights applicable to power-driven boats.
- Less than 7 m in length—the lights required for sailing boats over 7 m in length. If not, a torch or lantern showing a white light ready to display in order to avoid a collision.
- More than 7 m in length and less than 20 m in length:
 - a) combined lantern at or near the top of the mast that incorporates sidelights and stern light or
 - b) separate sidelights and stern light.
- More than 20 m in length—sidelights and stern light and may carry the optional red and green all round lights (they must not carry a combined lantern).
- Any length, which is fitted with sidelights and a stern light (but not a combined lantern) may, in addition, carry two all round lights in a vertical line at or near the top of the mast. The upper light shall be red and lower green.

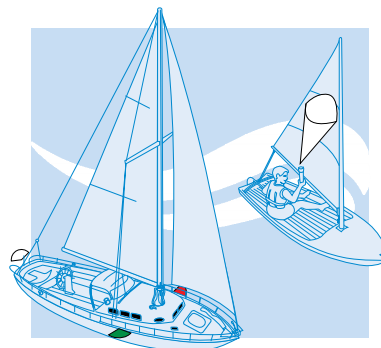

Non-powered boats

Boats being rowed—torch or lantern showing a white light ready to display in order to avoid a collision.

Ships engaged in rowing activities (training or competition) on the Brisbane River need to be fitted with an all-round, white, flashing light if they operate between the hours of sunset and sunrise.

Boats at anchor

Less than 50 m in length at anchor—an all round white light placed where it may best be seen.

Anchor lights must always be shown from sunset to sunrise. If you are at anchor or in a busy area, then show additional lights (not navigation lights) to ensure you are seen and keep a good watch.

Boats over 50 m should have two anchor lights—the higher one towards the bow.

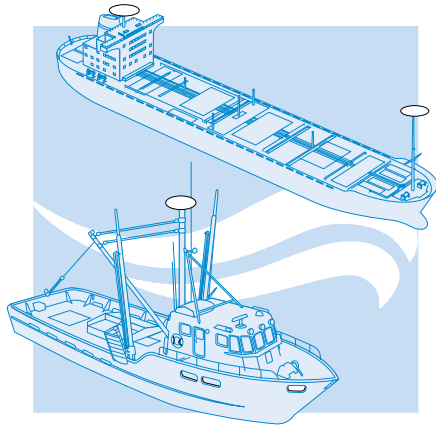

Boats to avoid

There are many other combinations of lights (used at night) and daymarks (used during the day) indicating the activity that the boat is engaged in, like fishing, dredging, not under command. The table below summarises the most common types.

A simple rule of thumb for a small power boat is to stay clear of any boats exhibiting additional lights.

Vessel	Day shapes	'Signature lights'
Not under command *	●	●● Replaces masthead light(s)
Restricted in ability to manoeuvre *	◆	●●●
Constrained by draft	▬	●●●
Engaged in fishing *	▲	●●●
Engaged in trawling *	▲	●●
Sailing		No masthead light
Power-driven		Masthead light
* displays sidelights and stern light only when making way		
Towing	◆	● * ● ** Up to 200 m
		● * ● ** Over 200 m
* replaces one masthead light (same arcs as masthead)		
** replaces one masthead light (same arcs as masthead) stern		
At anchor	●	●
Aground	●●●	●●●

Some of the more important boats to keep clear of include:

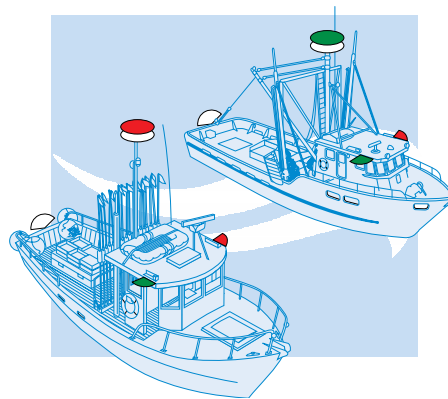

- boats engaged in commercial fishing and trawling

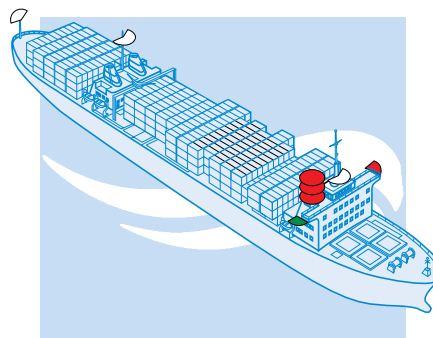

- large boats constrained by their draught in channels

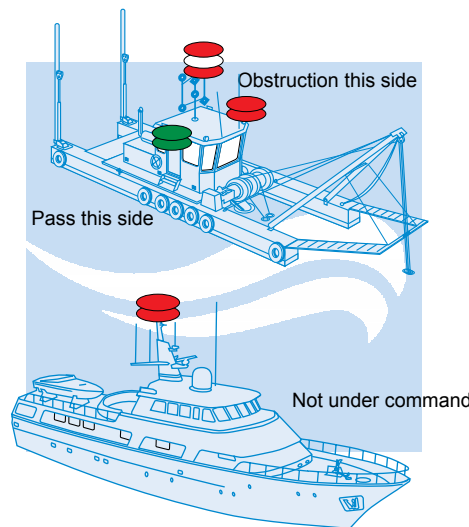

- boats restricted in their ability to manoeuvre because of their work, or because of exceptional circumstances (not under command)

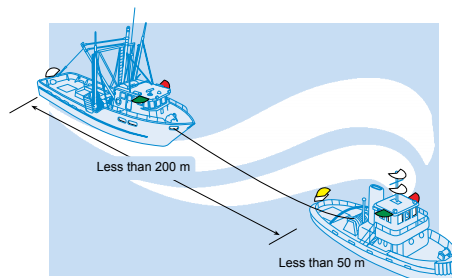

- boats towing another boat.

Cross-river vehicular ferries using wires or chains can be a particular hazard at night. Slow down to 6 knots or less when within 100 m of a ferry and sound a long blast before passing astern. Preferably wait until it has reached the shore to avoid becoming entangled in the wires. Generally, in Queensland, the ferry will display a flashing red light while cables obstruct the passage.

Navigation at night

Navigating your recreational boat at night can be quite an enjoyable experience. It can also be very dangerous if not approached properly.

Night navigation requires skill and concentration and should not be taken lightly. Perceptions change on the water after sunset. While on your boat at night, your depth perception decreases and distances and sizes of shores and navigational objects can look different. Waves are harder to see and judge and reflections in your boat's windshield can be confusing. Your night vision can be drastically reduced by bridge and city lights. All of these factors should be taken into consideration when navigating your boat at night.

Before navigating at night for the first time, it is a good practice to take someone with you that has night navigation experience. Always ensure that all your electronics are in good working condition and invest in a good quality spotlight. Remember that landmarks and navigational aids are going to look different at night and you will need your spotlight to double check buoy colours and numbers while underway. Always make sure that all of your navigation lights are operating and are not blocked from view by flags or other obstructions attached to your vessel.

When using your spotlight, you should take whatever steps you can to prevent from shining your spotlight into the wheelhouse of other boats. You can easily ruin another boater's night vision with your spotlight. Similarly, be prepared to look away from other vessel's spotlights should that skipper shine his light into your wheelhouse. Only turn your spotlight on for the amount of time you need it to light what you are looking at. Never leave your spotlight on continuously while underway as it can distract boaters that are a fair distance away.

When using your electronics, it is a good idea to turn down the brilliancy of their backlights. Your eyes will not have to adjust as drastically between looking at the waters ahead of you and looking at your electronics if you keep them as dim as possible. Also, remember, that after a few hours of looking at an electronic chart or GPS screen, you can very easily become fatigued and develop a headache. Don't hesitate to take a break and let someone else steer occasionally to help cut down on fatigue.

Unless you are involved in an emergency, there is no reason to navigate at full speed in the darkness. Navigate with caution and give yourself more time to react at night. Keep a very sharp lookout for unlit buoys and obstructions. All these objects can appear much smaller at night and can be dangerous and cause damage to you and or your boat.

When navigating in the vicinity of other boats in the dark, watch all the surrounding boats closely to ensure that they are not on a collision course with you. If a nearby boat appears to be on a collision course, take appropriate action, slow down or stop and if possible try to make yourself more visible. Turning your spotlight on without shining it directly on a nearby boater more often than not attracts just enough attention to alert the other boater of your presence. Remember; try not to hamper the other boater's night vision.

Use extra diligence in ensuring that your passengers and crew do not fall overboard at night. Locating a person in the water at night is very difficult and your chances of recovering that person are very slim. Keep less experienced passengers seated and don't let anyone wander onto open decks alone or unnecessarily. Always wear your life jackets and insist that everyone on-board your boat does as well.

All of these factors should be kept in mind when navigating at night. Remember that night navigation requires considerable focus and concentration and should not be taken lightly. Learning to navigate your boat safely at night can add a whole world of enjoyment to your boating career. Failure to learn proper night navigation techniques, however, can quickly land you in the middle of a very bad situation.

4.6 Navigating

Safe navigation is the most fundamental element of safe seamanship. Understanding the buoyage system and collision regulations are essential when travelling in complex and busy waterways. At sea, where there are no visual indicators, it is easy to lose all sense of direction. Navigation equipment like charts, compass, radar and satellite position systems are needed to keep safe and on course, particularly in restricted visibility.

At the most basic, a chart, watch and compass will enable you to plot a course. By noting the compass direction while heading out, you can tell the distance travelled by the speed of the boat and the time taken—a boat travelling at one knot will take one hour to travel one nautical mile.

More detailed instruction in navigation is beyond the scope of the BoatSafe course. Enquire at your local Coast Guard, Volunteer Marine Rescue or TAFE if you want to develop higher level knowledge and skills in this area.

Compass

A compass is a must on every boat. There are two types—a magnetic compass that points to the magnetic north and the gyrocompass which points to the true north. Most recreational boaters will have a magnetic compass which will have a magnetic variation. This is an error caused by the earth's magnetic field not being lined up with the true north (the axis of the earth's rotation). Magnetic variation may be east or west and may change from year to year. The change to be



applied may be calculated from information also supplied in the compass roses or isogonal lines. For example:

Magnetic variation (1995)	9° 43' E
9 years @2.5' (increasing)	23'+
Magnetic variation (2004)	10° 06E

Magnetic variation in Queensland varies from about 5° E in the Torres Strait to about 12° E at Point Danger.



The compass rose shown above demonstrates the variation between true north (shown as 'o' on black scale) and magnetic north for 2007 (shown with red arrow).

Global Positioning Systems (GPSs)

GPSs are commonly found on recreational boats, and while a good navigation aid, they should not be relied upon (like any other electronic equipment dependent on battery power). A GPS is able to provide a latitude and longitude, updated almost continuously. This can then be plotted on a chart and should be verified with a compass.



There have been a number of navigational incidents, where boats have run aground and into obstructions, attributed to people using GPS data alone. Some positions given by GPS will need to be adjusted due to differing datum (see cautionary advice on charts). As with all fixes, the GPS position should be checked against something else.

A GPS is not a substitute for sound watchkeeping and navigational practices and should be used only in conjunction with other aids to navigation.

Consider the following when using GPS and/or chart plotters:

- Masters should still maintain a proper lookout while the vessel is underway to identify any approaching hazards.

- Zoom to the largest available accurate chart scale. If the zoom recommended exceeds the accuracy scale limit then a warning message is displayed on the screen.
- It is advisable to switch the unit on and select the correct chart datum before departing. GPS units require time to initialize, and the master needs time to assess the accuracy of the position information prior to starting the voyage.
- The accuracy of GPS units can be compromised by power failures or poor electrical connections.
- Always ensure your electronic charts are updated with supplier upgrades.
- When going to a waypoint in a straight line, check what is in between your boat's initial location and the waypoint.

Before using your new GPS, you are obligated to familiarize yourself with the strengths and weaknesses of the equipment. As a starting point, it is recommended that GPS users undertake navigation and GPS courses currently offered by both Volunteer Marine Rescue (VMR) and the Australian Volunteer Coast Guard.

4.7 Local rules



In many areas of Queensland, our rivers, bays and harbours are under considerable pressure from high use by recreational boating enthusiasts. This handbook outlines most rules and regulations governing waterway activities across the state, but some local rules may apply to sewage, PWC use, speed limits, anchoring and other activities. Information about local rules can be obtained from local maritime authorities or signage. The Beacon to Beacon Directory (from the 7th issue) also provides this information.

Most importantly, there is no substitute for care, courtesy and commonsense. Be considerate to other members of the community—people on shore as well as those on the water.

Speed limits

Many boating areas have maximum speed limits which are enforceable. For safety reasons, it may be necessary to stay well below these limits depending on the conditions.

Before boating in unfamiliar areas find out if there are any speed restrictions through the local marine authority and obey speed restriction signs. The following restrictions apply to boats other than PWC throughout Queensland whether signs are present or not. For speed limits for PWC see page 91.



You must not operate your boat at more than 6 knots:

- within 30 m of
 - boats anchored, moored, made fast to the shore or aground
 - a jetty, wharf, pontoon or boat ramp
- within 30 m of people in the water
- in harbours and marinas.

Boats must stay at least 30 m from a diver in the water where a float or structure is showing a Code A flag.



Learn how to judge distance, for example 30 m is ten times longer than a 3 m boat and five times longer than a 6 m boat.

Even at slow speeds your boat will create a wash. Look behind at your wash and be aware of the effect this can have on other boats, people in the water, or the shore. Travelling at the speed shown on a speed restriction sign does not guarantee you are not creating excessive wash.

Mooring areas

Special mooring areas are located around Queensland with some marked on boating safety charts (shown below as 'Small Craft Anchorage'). Be aware of moored boats at all times, especially at night. When navigating near, in or through a mooring area drive slowly and keep wash to a minimum and keep a lookout for people in the water, small dinghies, and trailing ropes.



4.8 Bar crossings

Queensland has many dangerous bars where crossings should only be attempted by experienced boaters. Local knowledge, experience, the right kind of boat and good weather and boating conditions are critical factors for a safe crossing.

It is compulsory for all people to wear a lifejacket when crossing designated coastal bars in open boats less than 4.8 m.

Before crossing a bar:

- observe the wave patterns and conditions
- learn what you can from local operators or volunteer marine rescue groups
- find out if any leads or beacons are in place to assist with navigation
- cross with an experienced operator before attempting it by yourself
- ensure the boat is seaworthy and capable of taking impact from waves.



When this is done and you decide to cross the bar, the following precautions should be taken:

- prepare the boat by
 - checking the steering, bilge, hatches and drains
 - check all lifesaving equipment and ensure it is ready for an emergency
 - clear decks and secure all lines
 - secure movable items
 - ensure watertight integrity
 - check and test the engines, steering and controls
 - ensure the engines are drawing fuel from a full tank
- check the tides—best one hour before high and worst in mid-ebb
- get an up to date weather report for the time of departure and expected time of return
- report your intentions by radio to a volunteer marine rescue group and advise once you are clear of the bar
- have all people on board wear a personal flotation device.

Do not attempt a crossing in heavy swell and strong winds or on a run-out tide. Be prepared to cancel or delay the crossing.



Going out

The skill of crossing a bar is to know the best water by judging the wave pattern, crossing at the calmest point and manoeuvring the boat around breaking waves. Look for the deepest water or channel; going aground on a bar can be disastrous.

Tactics may vary between displacement boats (slow) and high-speed planing boats. Be patient and watch the sets of swells before choosing the best time to go. Once committed, keep going—attempting to turn around in front of an incoming wave can be disastrous. Do not hit the waves at high speed; take them as close to head on as possible. Some bars have waves breaking across the whole entrance and finding a way through may be difficult. Be prepared to take a wave head on and take water over the bow if you find yourself in a position where there is no alternative.

The boat must meet the incoming wave energy. Do not hit waves at high speed and do not allow waves to break onto your boat.

Some general principles may include:

- look for lulls and select a line of least wave activity
- where possible, cross on an incoming tide when the wave is running with the tide
- keep the boat generally bow on as the waves approach and do not let the boat turn sideways to a breaking wave
- head up into the waves and bear away quickly on their backs
- accelerate where possible, but avoid getting airborne
- head for saddles which occur between peaking waves about to break
- navigate quickly clear of the bar
- take back leads and marks to locate the entrance for the return trip.

Coming in

When coming in, speed boats (capable of at least 18 kn) should travel at the same speed as the waves. The aim is to travel in on the back of a wave, staying ahead of the waves breaking behind the boat. Again, watch for patterns and deeper areas:

- approaching from the sea, increase power to maintain speed within the sets of the waves
- position the boat on the back of the wave—do not surf down the face of the wave
- adjust the boat's speed to match the speed of the waves but do not attempt to overtake the waves.

Displacement boats may have to come in very slowly to avoid surfing and broaching-to (getting caught side on to a wave). In extreme conditions, the very difficult but vital decision not to come in may have to be made. It may well be safer to stand off in deeper water until conditions improve or to seek alternative shelter.

4.9 Navigating near shipping channels

Interaction between large ships and small craft is rapidly increasing in Queensland coast waters.

For example, trading through the Port of Brisbane is growing with an expected 7000 shipping movements annually. That's almost one every hour.

Ships can approach quickly and silently. It can take only 15 minutes from the time a ship is spotted on the horizon by a small boat to the potential time of impact.

At night, judgement of distance over water is more difficult. Ships do not have brakes and can take up to two nautical miles (about 37 football field lengths) to come to a complete stop.

Where possible, keep clear of ship navigation areas (major shipping routes, pilot boarding grounds, channels, swing basins and berths).

If you must navigate in a shipping channel, you must keep to the outer edge of that channel and must maintain an all-round visual watch including monitoring VHF radio channel 12/16 for the local traffic movement information.

If you need to cross a channel, always transit at right angles directly across a channel, behind a large ship, when it is clear and safe to travel.



Large ships at maximum draft have minimal under keel clearance and can only manoeuvre within the designated shipping channel. Please ensure to give these ships adequate room to navigate.



Large ships with the bridge at the stern will have a large blind spot for several hundred metres in front of the bow. The blind spot extends much further forward if deck cargo or containers are carried.

When in a swing basin or along side a berth, ships are accompanied by tugs and other vessels. Keep well clear.

Between sunset and sunrise, including periods of restricted daytime visibility, always show correct navigation lights when at anchor or under way.

Despite the fact that they attract fish, avoid anchoring or tying-up near a navigation aid (buoy or channel marker) in a designated shipping lane.

4.10 Waterskiing rules

Waterskiing involves the towing of a person or persons behind a boat (on skis, bare feet, inflatable toys, boards or a parasail). The owner or master is responsible for ensuring that the waterway is safe for skiing. Check for sufficient depth of water, width to make turns safely and any hazards.

Know the following waterski rules:

- When waterskiing stay at least 30 m away from people in the water, anchored or moored ships, boat ramps, jetties and pontoons. Travelling too close to boat ramps can impede the safe launch and recovery of other boats. Keep as far as possible from banks and shorelines.
- When skiing in rivers and creeks boats should travel in an anticlockwise pattern. In a few locations, local customs and conditions may dictate the direction of travel—always check before skiing.

Suggested water-ski signals



1. Start—nod the head.



2. Faster—open palm facing up motion upwards or nod head if both hands are in use.



3. Slower—open palm facing down motion downwards or shake head if both hands are in use.



5. Speed OK—arm upraised with thumb and forefinger making an 'O'—OK signal.



4. Speed required—use the number of fingers for km required. Therefore 23—first two fingers then three fingers.



6. Turns—palm vertical, curving motion of hand in direction required.



7. Whip off—point in direction and then give quick circular motions with hand.



8. Stop—hand up with fingers outstretched policeman style.



9. Back to dock—point, with downward swing of the arm.



10. Cut motor—finger drawn across throat in cutting motion.



11. OK after fall—after a fall, skier should clasp hands over head if unhurt, until seen by the boat driver.



- Skiers must wear a level 50, level 50 special purpose or level 100 lifejacket, or a wetsuit which has built-in buoyancy.
- A capable observer who is 13 years or more must be on board and should be watching the skier at all times.
- Obey the rules of the road at sea at all times.
- The operator of the towing boat must hold a valid marine licence.
- The operator must keep a proper lookout at all times and should not be watching the skier.
- The tip of the ski should be showing above the water before the towing boat is under way.
- The observer has to relay any signals from the skier to the operator and should alert the operator as soon as they see the skier fall.
- After a fall, a skier should clasp hands over their head until seen by the towing boat operator. Immediate action must be taken by the operator and observer if there is no signal from the fallen skier.
- A fallen skier getting into a boat should leave their skis in the water and swim towards the boat.
- The operator should stop the engine a safe distance away from the skier before collecting the skier.
- Skiers should enter a boat over the stern whenever possible.

4.11 Alcohol and drug obligations

Have a sensible attitude to alcohol on the water. The same alcohol limit, under 0.05, applies on boats as it does on the road. Breath testing may be conducted by the Queensland Water Police on the water, at boat ramps and in marinas as part of routine boat checks.

The master is responsible for the safe handling of the boat even if another person is actually driving the boat. It is therefore, the master's responsibility to stay below the 0.05 limit at all times and to ensure that any person driving the boat is also under the limit.

There are heavy penalties for persons convicted of operating the boat while under the influence of alcohol or a drug, ranging from monetary penalties to imprisonment and the marine driver's licence may be suspended or cancelled.

The signals above are suggestions only - organise between yourselves what you are going to use.

A master may be convicted of being in charge of a boat under the influence of liquor or a drug even though someone else is actually driving the boat—just like an instructor would be liable if under the influence while the driver, on a learner’s permit, is sober. This emphasises that the master is at all times responsible for the safety of the boat and all people on board.

Being under the influence of a drug does not refer only to illegal substances. Prescription medications may also pose problems, particularly if mixed with even a small amount of alcohol. Seasickness preventatives, hayfever and other allergy preparations can induce drowsiness and make you easily confused. Always check with a doctor or your pharmacist about the possible side effects of any medications or preparations you are taking before going boating.

The effects of alcohol are enhanced while on the water due to the sun, wind, waves and constant motion. It can erode sense of balance, fade vision, impair judgement, and adversely affect coordination, all of which reduce ability to safely handle a boat. Reflexes and response times to emergencies are slowed and swimming ability deteriorates considerably. If in the water, body heat is lost much faster and exhaustion, vomiting and choking are more prevalent.

4.12 Enforcement officers

Maritime Safety Queensland, Queensland Boating and Fisheries Patrol and Water Police enforce marine safety regulations. They regularly check commercial and recreational boat users for licences, registration, safety equipment and safe behaviour on the water.

The Water Police are responsible for crime prevention on the water and facilitate search and rescue activities in conjunction with the National Rescue and Coordination Centre in Canberra.

Note: all noise complaints must be directed to the Department of Environment and Heritage Protection.

All vessel-sourced marine pollution should be reported to Maritime Safety Queensland.



4.13 Marine incident reporting

All marine incidents must be reported to a shipping inspector within 48 hours by completing and lodging the approved ‘marine incident report’ form.

Reportable incidents include:

- the loss of a person from a boat
- the death of, or grievous bodily harm to, a person caused by a boat’s operations
- the loss or presumed loss or abandonment of a boat
- a collision with a boat
- the stranding of a boat
- material damage to a boat
- material damage caused by a boat’s operations
- danger to a person caused by a boat’s operations
- danger of serious damage to a boat
- danger of serious damage to a structure caused by a boat’s operations.



Common marine incidents include collisions with other boats, buoys, jetties and pontoons, fires, falls within a boat and persons overboard.

Incidents involving injuries to people must always be reported even if the boat does not sustain any material damage.

If in doubt about reporting the incident, contact a shipping inspector (Water Police, Queensland Boating and Fisheries Patrol or Marine Officers) for clarification.

Marine incident report forms are available from Maritime Safety Queensland, enforcement agencies and online at <www.msq.qld.gov.au>.

Why reporting is important

The reporting of marine incidents is not only a statutory requirement, it is also vital to Maritime Safety Queensland. The information collected assists in the development of safety standards, education, and on-water compliance programs that benefit all waterways users.

In addition, reporting a marine incident may assist you if you decide to make insurance claims on any damage. Most insurance companies will not honour claims if the marine incident has not been officially reported. They may also require that you provide them with a copy of the lodged marine incident report form.

How to report marine incidents

A marine incident must be reported to a shipping inspector within 48 hours of the incident, unless you have a reasonable excuse for not doing so within this timeframe.

Shipping inspectors include Marine Officers (located at Maritime Safety Queensland offices and bases), Queensland Water Police officers and Queensland Boating and Fisheries Patrol officers.

The report must be made on the approved form (marine incident report form F3071). These forms are available from shipping inspectors, Department of Transport and Main Roads customer service centres or the Maritime Safety Queensland website.

This form is used to report all incidents, no matter what type of ship is involved.

The form may be completed with the assistance of a shipping inspector to ensure the information is accurate, unbiased and as reliable as possible. It is important that the form is filled in completely, with the incident described in as much detail as possible. The shipping inspector who receives the form will check to ensure it has been correctly completed in full detail.

If a marine incident involves the loss or presumed loss or abandonment of a ship, the owner must report the marine incident. For all other incident types the master is responsible for reporting the marine incident. If the initial report is not made in the approved form, the owner or master must make a further report to a shipping inspector in the approved form as soon as possible. Each marine incident reported will be investigated by a shipping inspector and the results fed back to the person reporting the incident.

The investigation may be as simple as a thorough examination of the marine incident report form and a decision that no further action is required, or it may require an investigation complete with interviews, statements, surveyors' reports and the preparation of a prosecution brief.

It is an offence not to report a marine incident and can result in a maximum penalty of 40 penalty units for an individual and 200 penalty units for a company.*



* As at 19 January 2017, the value of a penalty unit in Queensland is \$121.90. Refer to the *Penalties and Sentences Regulation 2015*.

Incidents involving more than one boat

If you are involved in an incident involving more than one boat it is a legal requirement (in addition to reporting) to:

- render any possible assistance without endangering passengers or crew
- stay at the scene of the incident to ensure the safety of all involved
- give details of the owner of the boat to the operator of any other boat involved
- assist any injured person(s)
- assist the owner with any damaged property.

Assisting persons in distress

All boaters have a legal obligation to assist persons in distress unless:

- they are unable
- assistance is not required
- the circumstances are unreasonable (unsafe) for the boat.

If an accident occurs nearby, it is a legal requirement to assist where possible, provided it does not seriously endanger your boat or passengers.

4.14 Pollution

Small commercial and recreational boats conducting everyday activities like refuelling, fishing or emptying bilges cause much of the pollution we see in waters, harbours and marinas.

Sensible environmental practices when using and maintaining our boats will go a long way to preserving the aquatic environment for future generations.



The Department of Environment and Heritage Protection (EHP) is the lead agency for environmental management within Queensland, however, Maritime Safety Queensland is responsible under the *Transport Operations (Marine Pollution) Act 1995*, for managing the prevention and minimisation of marine pollution from ships, out to three nautical miles from the territorial sea baseline (Queensland coastal waters).

Waters beyond these limits are subject to the *Protection of the Sea (Prevention of Pollution from Ships) Act 1983 (Cwth)*. The penalties for breaching Queensland pollution regulations can be up to 5000 penalty units for an individual and up to 100 000 penalty units for companies.

Garbage

Garbage includes all kinds of victual, domestic and operational waste, including plastics, generated during the normal operation of the boat. Marine animals and sea birds often mistake plastic material for food and often end up dying a slow and painful death from starvation or strangulation. Garbage generated on board must be disposed of ashore. Garbage does not include fresh fish and parts of fresh fish, or the release of small amounts of food wastes for the special purpose of fish feeding.

The general rule is no discharge of garbage overboard. It should be stowed on board and disposed of responsibly once you are back on shore.

No plastics (synthetic ropes, fishing lines, nets or bags) should ever be thrown overboard.



Some tips for minimising pollution from garbage include:

- Avoid taking plastics on board (use crockery or disposable plates and cutlery).
- Carry food in reusable airtight containers and leave plastic wrappers at home.
- Store garbage in a strong garbage bag or container.
- Don't throw tangled fishing line overboard and pick up any discarded line you see.
- Don't throw anything overboard, including cigarette butts.

Oil and chemicals

Unfortunately some boat operators deliberately or accidentally discharge oil and chemicals into our waterways through refuelling, boat maintenance and bilge discharges.

Owners and operators must ensure no oil or chemicals are discharged from the ship into the sea. They are toxic to marine and human life.

Oil products on boats include:

- petrol
- diesel
- two-stroke oil
- motor oil
- gearbox oil
- hydraulic oil.

Chemical products on boats include:

- cooling system additives
- cleaning agents
- degreasers
- acids and paints.

All boat operators need to manage the use and disposal of oil and chemicals kept on board properly.

Some suggestions to reduce accidental pollution include:

- Always check the capacity of fuel tanks before refuelling.
- When refuelling, insert the nozzle into the filler before starting the pump. Always turn the pump off and ensure that the flow has stopped before removing the nozzle.
- Watch the breathers for signs of blow-back or overflow.
- Do not overfill your fuel tank (leave 2% for expansion).
- If you overfill your fuel tank, wipe the spill up with a rag. Do not hose the fuel into the water.
- Plug scuppers and block freeing ports during refuelling.
- Fit bilge filters.
- Always supervise the operation of bilge pumps. Keep an eye on the discharge when pumping to make sure no oil or chemicals get pumped out with the water.
- Review the installation of your bilge pump's float switch to stop oil accidentally discharging with bilge water.
- If you use degreasers and detergents, including biodegradable products to clean your bilges, make sure the residue is not discharged into waterways.
- Use absorbents to clean waste oil from your bilge and always dispose of the absorbents appropriately.
- Make sure your boat and its engines are in good working order—regularly check seals, gaskets, hoses and connections for leaks and drips.
- Repair oil and fuel leaks when first noticed.
- For everyday deck scrubbing use clean water—use chemicals only for severe staining.
- Read product information before you decide on any chemical cleaner. If it is toxic to humans, it is not good for marine life either.
- Use phosphate-free biodegradable detergents.
- Wipe cooking utensils and plates clean with a paper towel before washing up.
- Carry absorbent material on board to clean up any accidental spills.
- When possible, remove your boat from the water and clean where debris can be captured and disposed of properly.
- When your boat is being scraped or sanded, use a vacuum sander or place a drop sheet underneath to catch paint scrapings and dust. Dispose of these residues carefully.

- When painting your boat's hull, use the right paint for the job and be sure to follow the application instructions carefully. Check with a marine painting professional to determine if there are alternatives and choose the most environmentally friendly product(s).

Sewage

The discharge of sewage from boats reduces water quality, poses a human health risk and decreases visual aesthetics of waterways. The table on page 71 outlines current discharge restrictions.

For further information on sewage management including maps showing permitted and prohibited discharge areas, please refer to the Maritime Safety Queensland website.

Boat owners and operators must adopt sewage management measures if sewage is likely to be generated on board. This could be as simple as using a portable toilet, installing a holding tank or a sewage treatment system on board your boat.

Please refer to Transport Operations (Marine Pollution) Regulation 2008 - Schedule 3, Section 44.

Noise

Be considerate about noise as it is amplified on the water, making engine noise and music appear louder. For the enjoyment of everyone, noise should not be offensive.

Factors to be taken into account include:

- character of the noise
- quality of the noise
- noise level
- effect the noise has on activities
- time of the noise event
- waterside land use
- number of people affected.

Noise also disturbs wildlife. Care should be taken to reduce noise in the vicinity of waterbirds and other animals.

As a general guideline, for recreational ships (including personal watercraft), the maximum noise level for engines is 85 dB(A) at 30 m. Complaints regarding noise should be directed to the Department of Environment and Heritage Protection or the respective local government authority (Council).

Reporting

All marine pollution incidents must be reported to the local Regional Harbour Master's office detailing:

- when and where the pollution occurred
- what type of substance was discharged
- the extent of the pollution
- the name, size and type of boat
- any other relevant information.

4. 15 Marine animals and habitats

Take care when anchoring. Sub-marine habitats, such as seagrass and corals, can be severely damaged by anchors. Seagrass beds are important fish habitats and help bind the sea floor and improve water quality.

Note the following:

- try to anchor in sand away from coral and seagrass
- use a reef pick with heavy plastic tubing over the anchor chain
- motor up when hauling in the anchor.

Where there are no approved moorings, anchoring limits may apply in some marine park areas to prevent damage to seagrass, coral and bottom-dwelling animals and to manage pollution and boat numbers.

Marine parks may also encompass areas to protect endangered and vulnerable animals (for example turtles and dugongs) from boat injuries and disturbance.



When boating in these areas:

- go slow in a non-planing or displacement mode
- operate your boat in a way to avoid hitting a turtle or a dugong and maintain a good lookout
- do not drive your boat across shallow, weedy areas, as boat propellers may damage seagrass.

Recreational boaters should not approach closer than 100m to whales or dolphins. When within 300 m of a whale or dolphin you should:

- maintain a constant speed not exceeding five knots
- avoid sudden changes in direction
- not approach a whale or dolphin head on
- not be in the path of a whale or dolphin
- not separate a whale or dolphin from its group
- not come between a mother and her young.

Heritage wrecks

Any ship that sank more than 75 years ago is protected by state and commonwealth regulations. Protected zones have been declared around some particularly fragile and historic shipwrecks and these are shown on nautical charts. It is an offence to enter a protected zone.

It is also an offence to damage, disturb or interfere with any historic shipwreck. This includes anchoring on it or removing objects from the wreck.

Transfer of exotic weeds

Introduced and trans-located species can have a devastating effect on the local marine eco-system. Prevent the spread of exotic aquatic weeds such as caulerpa taxifolia. Remove all plant fragments from trailers, propellers, anchors, ropes, chains and fishing tackle. Collect all pieces in a plastic bag, seal it and put the bag in a bin.

	SHIP-SOURCED SEWAGE
Prohibited discharge	<p>Prohibited discharge waters</p> <p>No discharge of treated and untreated sewage in the following waters:</p> <ul style="list-style-type: none"> • a boat harbour • a canal • a marina • a designated area including: <ul style="list-style-type: none"> – a marine national park zone described in the Marine Parks (Moreton Bay) Zoning Plan 2008 – a marine national park zone, under the Marine Parks (Great Sandy) Zoning Plan 2006, located near Burkitt’s Reef, Hoffman’s Rocks or Barolin Rock, adjacent to the Woongarra Coast – an area within the Great Barrier Reef Coast Marine Park mentioned in schedule 8A of the Transport Operations (Marine Pollution) Regulation 2008. <p>Declared ships (class 1 commercially registered passenger carrying ships) fitted with a fixed toilet must have a sewage holding device if operating in areas where discharge is not permitted.</p>
Untreated sewage	<p>Nil discharge waters:</p> <p>In those waterways where discharge of sewage is permitted, sewage discharged from all boats with a fixed toilet must first pass through a macerator.</p> <p>Smooth waters (includes rivers, creeks and designated smooth waters):</p> <ul style="list-style-type: none"> – nil discharge (all ships). <p>Hervey Bay and Northern Moreton Bay waters:</p> <p>For a declared ship:</p> <ul style="list-style-type: none"> – nil discharge. <p>For all other ships:</p> <ul style="list-style-type: none"> – nil discharge within 1 nm (1852 m) from reefs, aquaculture fisheries resources and the mean low water mark of the mainland. – if 16 or more persons on board, nil discharge. <p>Open waters:</p> <ul style="list-style-type: none"> – for all ships—nil discharge within 1 nm of aquaculture fisheries resources – for ships with 7 to 15 persons on board—nil discharge within 1 nm of a reef, the mean low water mark of an island or the mainland – for ships with 16 or more persons on board—nil discharge in open waters.
Treated sewage	<p>In those waterways where discharge of sewage is permitted, sewage discharged from all ships with a fixed toilet must first pass through a macerator.</p> <p>Smooth, Hervey Bay and Northern Moreton Bay and open waters</p> <p>Treated sewage can be discharged subject to the following restrictions:</p> <p>Grade C treated sewage</p> <p>Nil discharge within 1/2 nm (926 m) of:</p> <ul style="list-style-type: none"> – a person in the water – aquaculture resources – a reef. <p>Grade B treated sewage</p> <p>Nil discharge within 700 m of:</p> <ul style="list-style-type: none"> – a person in the water – aquaculture resources – a reef. <p>Grade A treated sewage</p> <p>No restrictions other than prohibited discharge waters.</p> <p>Declared ships (class 1 commercial ships) must have a sewage holding device suitable for the number of persons and duration of journey in those waters if operating in any waters where discharge is not permitted.</p>
	<p>Declared ships are required to have a shipboard sewage management plan on board with particulars described at section 49 of the <i>Transport Operations (Marine Pollution) Regulation 2008</i> and to keep sewage disposal records when discharged to a sewage disposal facility.</p> <p>All ships with a treatment system are required to have system documentation and manuals on board for operating and maintaining the system.</p>

Section 4 activities

Activity 1

When going upstream (away from the ocean), which side of the boat should you keep the port lateral mark?

- A pass with it on your port side
- B pass with it on your starboard side

Activity 2

How is the buoyage direction marked on a chart?

Activity 3

If you see a mark that is yellow and black in colour and it has two black cones pointing inwards, what is it and what side do you pass it?

Activity 4

If you see a north cardinal mark and you are unsure which way north is, how could you work it out?

Activity 5

List five things a special mark could be used for.

1

2

3

4

5

Activity 6

How should you keep a proper lookout?

Activity 7

Circle the boat required to give way in the following pictures

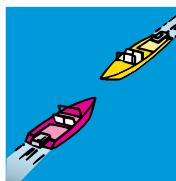

Head on

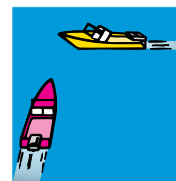

Crossing

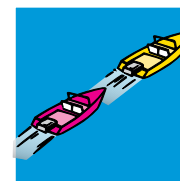

Overtaking

Activity 8

Which boats have special rights over power boats?

Activity 9

By law, when must navigation lights be displayed?

Activity 10

A speed limit of 6 knots or less within 30 m applies to:

Activity 11

What is your responsibility in relation to the wash your boat creates?

Activity 12

What is the legal alcohol limit on the water?

Activity 13

Within what time must you report the incident, and who should you report to?

Activity 14

When operating your boat near shipping channels which radio channels should you monitor for up-to-date information on local traffic movement of larger ships?

Most emergencies afloat can be avoided by good seamanship. However accidents can happen, so be prepared to handle them.

Marine safety regulations provide safety equipment requirements and advice designed to keep boats safe and prepared to handle emergency situations.

Below are a number of basic steps to employ in an emergency situation:

- do not panic, remain as calm as possible
- consider the weather conditions and how they may affect the capabilities of the boat
- have safety equipment ready and life jackets on
- attract attention from any passing ship or persons on land, if close by, either by waving or by using a flare if the situation becomes desperate
- check to make sure there is no danger of fire or explosion
- if hull is holed, block entry with any suitable material that will slow down the entry of water
- if you have a V-sheet, place it on top of the boat and secure properly
- if you have a VHF radio, use it to call for help.

5.1 Engine failure

Even the best-maintained engine can fail, so it is important to learn the basics of engine repair—practise troubleshooting problems and carrying out emergency repairs. Always carry essential tools.

Before attempting to carry out any running repairs while on the water use an anchor to check drift and face the bow into the sea to help to keep water off the engine. Work under a waterproof cover large enough to keep spray off the engine as a wet ignition can often frustrate attempts to restart an engine.

Learn to distinguish the sound of an engine not running normally.

It is good practice to carry an auxiliary motor maintained in good operational order and ready for immediate use if required.

5.2 Abandoning the boat

- Make sure that everyone is wearing a lifejacket before going over the side.
- Send a distress call if the boat has a radio.
- Send off distress flares only if they are likely to be seen.
- Activate your EPIRB if carried.
- Unless there is an uncontrollable fire, don't leave your boat. Most boats involved in accidents don't sink and

can be seen better than a person in the water. A partially submerged boat can also be used for support.

- Restrain any impulse to swim ashore. Distances over water usually appear shorter than they actually are. It is always safer to stay with the boat unless you are sure that land is within swimming distance.
- Huddle together to reduce heat loss. Avoid excessive physical activity, such as swimming, that will increase body heat loss.

5.3 Fire

Fire prevention can be achieved through good housekeeping. It is essential to know how to fight a fire and have the correct equipment on board but never having to fight fire is a far better course of action.

Good housekeeping includes:

- have the correct fire extinguishers on your boat, know how to use them, maintain them and locate them in accessible areas—not near the source of a potential fire
- keep the bilge and engine room clean and free of rags, newspapers and other combustible materials
- regularly check that engine rooms and batteries are properly ventilated
- use only appliances such as stoves and heaters that are approved for marine use
- never use cigarette lighters or matches while searching in lockers, use a battery powered torch
- check fuel systems at regular intervals for leaks and spillage
- any spare fuel should be carried in approved containers
- check the electrical system regularly for faults and keep all components as clean as possible.

Common causes of fires among smaller boats include:

- engine backfiring in air laden with combustible vapour
- hot exhaust pipe igniting adjacent combustible materials
- on inboard powered boats, fuel lines can leak or rupture and spray fuel over hot exhausts
- spontaneous combustion of oil rags in badly ventilated compartments
- a spark caused by static electricity during refuelling
- fuel vapours collecting in the bilge due to spillage while refuelling
- leaking LPG which is heavier than air and will find the lowest point in the boat, usually the bilge
- short-circuiting and overloading of the electrical system
- smoking in bed.



Remember, to avoid potential fire hazards—all fuel systems, electrical systems and LPG systems should be correctly designed, installed and maintained by qualified persons.

When refuelling your boat:

- turn off all engines, motors, fans, heating devices, electrical equipment and LPG appliances
- don't smoke or allow naked flames on or in the vicinity of your boat
- fuel spilled, either accidentally or from overflowing the fuel tanks, produces vapours which can enter the bilge and may be ignited by a spark—often from the boat's electrical system
- have a fire extinguisher handy
- wipe up all spills
- leave room in tanks for fuel expansion
- check bilges for leakage and fuel odours—ventilate until fuel odour is gone, before starting engines
- never refill portable fuel tanks in the boat—take them ashore for filling and wipe off any spillage before replacing them aboard.



Fuel related fires could also start when a boat is cruising. These fires generally result when some component of the fuel system starts to leak and vapours trapped in the ship's bilge are ignited. Regularly inspect and maintain fuel systems and avoid using temporary or 'stop gap' solutions to fix leaks.

Electrical installation

Fires and explosions aboard small boats are frequently caused by short circuits or overloading. To ensure protection from these hazards, have all electrical installation and maintenance carried out by a qualified marine electrician.

Fighting the fire

- Raise the alarm (to others on board and to rescue organisations).
- Manoeuvre the boat to operate with the least wind effect (generally down wind).
- If within an enclosed or confined space, close all the hatches, vents and ports to reduce oxygen.



- If a burning object can be safely moved, get it over the side quickly.
- Shut off fuel lines and gas lines as soon as possible as flexible fuel lines may collapse and add to the fire.
- Try to extinguish the fire with fire fighting appliances and remember to direct the extinguisher into the heart of the fire, not the flames.
- Maintain a watch on the area once the fire has been extinguished to monitor any reflashes.
- If the boat needs to be abandoned, do not motor alongside another boat. Do not leave the boat on the leeward (downwind side) as the boat may drift onto you or any fuel may spread in the water.
- Consider isolating the battery and shutting down the generator if the fire is in that location. Dependant on the location, power to run fire fighting and communication equipment may be advantageous.

Helping another boat on fire

Be extremely cautious approaching boats on fire and keep to the windward side. Most fires on small boats originate from fuel, heating appliances, stoves, leaking gas or fat. Fuel and gas fires spread very quickly. Even a minor spill can create a rapid spread of flames.

Theory of fire

There are four elements of fire. If these elements are brought together in sufficient quantities, then a fire will occur.

The elements are:

1. fuel
2. heat
3. air (oxygen)
4. chemical reaction.

Removing these elements will extinguish the fire:

1. removal of **fuel**—starving
2. removal of **heat**—cooling
3. removal of **oxygen**—smothering.

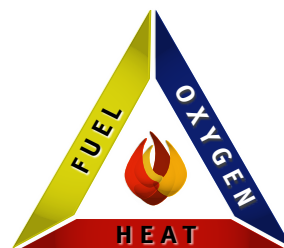

Fire triangle - remove one and you stop the fire

LPG

LPG is the most dangerous substance on boats if not handled correctly. Leakages cause suffocation and explosions.

LPG is stored in cylinders under pressure as a liquid. When the cylinder valve is opened, some of the liquid boils off as a gas vapour. When ignited, LPG can be used to fuel a number of appliances including stoves, refrigerators and water heaters.

In the event of an accidental gas leak, stop all motors, close all cylinder valves, turn off all appliances and ventilate the boat. Do not operate any electrical switches until the air is clear.

In the event of fire, LPG cylinders should be removed from the heat source. If this is not possible, keep the cylinder cool by spraying water on it.

If flames are threatening to engulf a gas cylinder, the boat should be evacuated.

Safe gas practice includes:

- Turn off all appliances and close the cylinder valve before you leave the boat.
- Display 'no smoking' and 'turn off the gas' signs below.
- Check that appliance cocks are closed before opening the cylinder valve.
- Develop a routine of turning off the gas at the cylinder before turning off at the appliance when finished. This lets the appliance burn out and reduces pressure in the pipeline.
- Keep areas around appliances clean (especially of grease or fat) and free of flammable materials.
- Know the smell of LPG.
- Make a periodic check of appliances, lines, connections and joins using soapy water applied with a paintbrush—bubbles indicate leaks. Never use a match to check for leaks.
- Install a gas detector.

5.4 Capsize

Capsize is a major contributor to boating fatalities, so make sure your boat is appropriate for the conditions and has built-in flotation (preferably level flotation).

A boat will capsize from either one or a combination of the following:

- Overloading slows the boat down and reduces the amount of freeboard (area above the waterline). A low freeboard increases the possibility of swamping the boat or taking on water, slowing the boat even more.
- Improper weight distribution can make the boat even more unstable. You must locate persons and equipment in order to balance the boat and keep water out.
- Waves can be a major factor in capsizing, especially if they are unexpected. Anticipate all waves and aim the bow into them. Always check the weather before and during boating.

Should your boat capsize, take a head count to make sure everyone is there, check for injuries and stay with the boat.

If you can, turn the boat upright and bail it out. Once most of the water is out, climb back in. Or, if close to shore, just climb in the boat and paddle. It will be exhausting but at least you will be safely ashore.



Never swim away from a capsized boat.

Small dinghy-type boats have sufficient flotation to keep afloat if upturned. To right an upturned boat, grab the keel and roll the boat toward you. As the boat starts to turn, grab hold of the gunwale and continue to roll the boat until it is right side up.

You then have an opportunity to bail the ship out.

When reboarding a boat at any time, board over the stern where the freeboard is lower and the ship is most stable. Never board or attempt to board over the side.

Refer to the abandoning the boat section on page 73.

5.5 Person overboard

Most boating fatalities happen when people fall overboard, even in calm waters close to shore. When people fall overboard, the worst thing to do is jump in after them. The potential drownings immediately double.

Person overboard procedure

Fast action and constant observation is the priority.

- Whoever first sees or hears someone go overboard must alert the master and not lose sight of the person until alongside.
- Turn the bow of the boat quickly toward the side the person went overboard and stop the boat. Turning toward the person will push the stern and propeller away.
- Immediately throw a life-saving device toward the person to give assistance with keeping afloat. At night, turn on and throw over a floating torch near the victim. Use another available light to illuminate the area.
- Quickly establish your position either by reference to shore marks or by a GPS position. An accurate position will be essential if the search requires outside assistance.

Victims may be hurt, cold and exhausted. If they cannot help themselves, it is difficult to get them back into the boat and you may need some sort of apparatus (for example a rope ladder or a loop of rope) to assist.

Do not go into the water to assist the person unless absolutely necessary. If the victim is unable to board or needs further assistance and someone must go into the water, make sure that person has a lifejacket on and is attached to the boat with a line.

5.6 Grounding

Grounding can cause material damage to the boat (hull and propellers), environmental damage to the sea floor and injury to occupants through sudden jarring.

To avoid running aground:

- Know how to read the beacons marking the channel. If in doubt slow down until you are sure of the channel ahead.
- Familiarise yourself with the area at low tide. This will give you a better perspective of where navigable water is.
- Talk to more experienced boat owners about what to look for that means shallow water. For example: ripples on the surface, surface formations changing suddenly, different water colour.
- Wear polarised sunglasses which highlight shallow areas.
- Use a chart and an echo sounder to read depths.
- Don't guess the depth of water, test it at slow speed.

If you go aground in a displacement hull boat or a yacht, there is a risk of the boat 'falling over' if the boat goes high and dry with the outgoing tide. In most cases, the boat will rise and float again on the high tide. However, if the boat's freeboard is low, water can enter the boat and sink it as the tide rises.

Hardwood planks can be propped under the gunwales to hold the boat upright in the event of being beached high and dry, especially yachts which will not balance on their keel.

5.7 Personal survival

Lifejackets

Most boating deaths occur in incidents involving small boats, and more than 80% of drowning victims were not wearing a lifejacket. Everyone on board small boats should wear an approved lifejacket that fits properly and is suitable for the type of boating.

The various types of lifejacket are listed in the safety equipment section (page 33).

Hypothermia

Boaters have a greater exposure to the elements than most. Boating in the cooler weather means a higher risk of developing hypothermia from wind-chill, capsized and damp and wet clothes.

Hypothermia or exposure is the effect of severe heat loss from the body, particularly from the core organs. Immersion in cold water causes the body to lose heat up to 25 times faster than normal and the shock of sudden immersion in cold water can be a serious threat to people who are older, unfit or under stress from falling overboard or abandoning ship. Cold winds on wet clothing and exposure to the elements for long periods can also result in hypothermia.

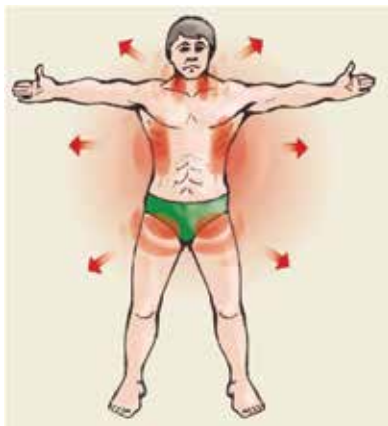

Various techniques can maximise survival time in the water. The main ones are:

- HELP (heat escape lessening posture) minimises the main areas of heat loss—the head, sides of the chest and the groin.
- Treading water is a well-known technique requiring continuous movement of the arms and legs. If not wearing a life jacket, try to hold on to a buoyant object to maintain the head above water.



- Huddle is where persons in the water, by huddling closely together so that chests and arms are protected, can increase survival time by up to 50% by reducing the rate at which the body loses heat.



5.8 First aid

First aid training

Coping with accidents and emergencies at sea needs a cool head and clear thinking. Expert assistance will probably not be at hand so skippers and crew of small boats need to have the basic first aid skills required to respond with knowledge and confidence. Red Cross, St John Ambulance, Queensland Ambulance and other providers conduct regular courses in first aid—the skills they teach could save a life.

Keep an appropriate first aid kit on board, with equipment to provide initial treatment for common injuries. You can make up your own in a suitable, strong waterproof container, or buy one ready-packed from a first aid provider.



If first aid is required at sea, make sure the boat is under proper control and seek medical assistance as necessary.

Signs and symptoms of hypothermia

Immersion in cold water can quickly affect the brain creating a dangerous situation as the person may not realise they are in danger. Hypothermia can be difficult to recognise because it is often mistaken for drowsiness. However, the following signs and symptoms will help you make an assessment:

- intense shivering (mild hypothermia)
- no shivering (severe hypothermia)
- quiet, difficult to rouse, may be unconscious
- pale, cold skin
- slow pulse, can be irregular
- slow, shallow respirations
- blurred, or double vision
- slurred speech
- confusion
- increasing drowsiness and lack of coordination.

Treatment for hypothermia

Aim to reduce any further heat loss and try to commence rewarming slowly by:

- Putting the patient in shelter, protected from wind and rain
- Minimising movement and disturbance
- Preventing further heat loss by removing wet clothing in a stable environment, and warming the person gradually by wrapping in an aluminium 'space blanket', layers of dry clothes, blankets, newspaper or a sleeping bag. Never put the person close to a fire or in a hot bath
- Dry the patient if wet
- Using your own body heat to warm the patient. Huddle together or share a sleeping bag. Pass warm breaths across patient's mouth and nose
- Gently warming the area of high heat loss, that is, head and neck, sides of chest, armpits, and groin. Do not warm, rub or massage limbs
- Giving warm, sweet drinks (never alcohol) if conscious.

Commence resuscitation if necessary and organise transportation of the victim to medical aid without delay. Their survival could depend on it.

Heat exhaustion

The danger signs of heat exhaustion include faintness, giddiness, headache, nausea and cramps. The patient may appear pale and clammy, with excessive sweating, rapid breathing and pulse.

With further dehydration, the skin becomes hot and dry.

- Move the patient to the shade, lying them down
- Remove unnecessary clothing and sponge torso with cool water
- If possible, improvise a fan for cooling the skin
- Call for help - dial triple zero (000)
- Give frequent drinks of water.

Unconsciousness

Once an emergency has occurred, check to ensure the scene around the unconscious person is safe of hazards and there is no risk to yourself, bystanders and the casualty.

Check the casualty for a response by touching the casualty's shoulders and asking in a loud voice if they are alright.

If the casualty responds:

- place them in a safe and comfortable position and call for help.

If the casualty does not respond:

- shout or send for help - call triple zero (000)
- check the airway is open and clear of any obstructions
- check if unresponsive, not breathing normally or not moving
- look, listen and feel for breathing – if in any doubt, treat as if the casualty is not breathing.

Shake the victim firmly but gently and try to get a response to a loud call.

If there is no response, check for signs of life:

- Airway—make sure the nose and mouth are clear
- Breathing—loosen upper clothing and observe chest movement. Feel and listen for breath from the nose and mouth.

If breathing:

- gently roll them onto their side
- observe and reassess consciousness
- monitor vital signs regularly (pulse and breathing).

If breathing is absent begin resuscitation immediately:

- start compressions
- kneel beside the casualty
- place hands interlocked in the centre of the casualty's chest
- press straight down on the sternum (1/3 of the depth of the chest)
- give 30 compressions (at a rate of 100/minute)
- give two breaths
- continue cycle of 30 compressions then two breaths until person regains breathing or help arrives.

Continue observing for signs of life:

- If the patient can breathe alone, turn on their side. Vomiting may occur, and choking if lying on the back
- Ensure help is on the way
- Continue resuscitation until recovery occurs or medical aid arrives.

Cardiopulmonary Resuscitation (CPR)

If there is no breathing and no signs of life, begin CPR (see chart page 79).

Poisonous stings

Many sea creatures are venomous. Avoid handling creatures in rock pools and washed ashore on beaches, and do not swim where jellyfish are prevalent.

In tropical waters, box jellyfish and irukandji can give dangerous, even fatal stings. Box jellyfish (*right*) cause immediate onset of pain and symptoms. Irukandji symptoms can be delayed from five to 60 minutes. Flood the area with household vinegar and observe the casualty's breathing. Seek urgent medical assistance and be ready to resuscitate.



The blue-ringed octopus and cone shell spine have potentially fatal toxins which can cause paralysis affecting the person's breathing within minutes. If bitten on a limb, use a wide bandage to apply firm pressure over the whole limb, then immobilise it with a splint. If necessary, apply resuscitation and seek urgent medical assistance.

Seasickness

There are several ways to prevent or minimise seasickness:

- Avoid alcohol and heavy, rich foods before and during the trip.
- Focus on the horizon, not on the water.
- Stay in the fresh air on deck, away from fumes.
- Keep occupied.
- Nibble on a dry biscuit, chew barley sugar or dried fruit. Ginger is also considered a good anti-seasickness remedy.
- Use medication before the trip (but be aware that some seasickness treatments can make you drowsy or have other unpleasant side effects).

If all else fails, the only cure for seasickness is to sit under a tree.

Bleeding

A small cut can be treated easily by washing with a disinfectant solution and closing with a suitable dressing. Pressure applied directly to the wound is the most effective way to stop bleeding. Elevation of the injured part will also help to control bleeding.

To treat life threatening bleeding:

- Call for help
- Expose wound
- Apply direct pressure over wound with a clean or sterile pad
- Lie the casualty down and raise the injured part above heart level if possible
- Apply a dressing and firm bandage, checking circulation to the limb every 30 minutes
- Treat for shock and monitor consciousness, pulse and breathing

If unable to stop the bleeding:

- Consider a constrictive bandage
- Remove clothing from part or limb
- Apply bandage (minimum 5 cm that is not too elastic) firmly to whole limb and tighten until bleeding stops
- Do not cover bandage to ensure it remains easily seen.

Burns

Treating burns should be done in such a manner as to relieve pain, prevent infection and prevent or treat for shock.

Gently and quickly cool the burned skin for up to 20 minutes with clean, fresh water. Resist using other substances, including sea water. Also consider:

- covering the area with clean, non-stick sterile dressing
- removing tight clothing and objects such as jewellery
- removing contaminated or smouldering clothing unless it is sticking to skin
- treating for shock if a severe burn
- flushing chemicals from skin, paying special attention to eyes
- do not break blisters
- avoid lotions, antiseptics and creams
- avoid excessive cooling which results in shivering
- seek medical advice.

Sun exposure

To treat sunburn, apply a cool, moist compress to the affected area but do not break any blisters. Give the patient plenty of fluids and seek medical attention quickly.

Shock

Untreated, shock can cause death from a collapse of the cardiovascular system carrying oxygen to the body's vital organs. The signs of shock may include cold, clammy skin, profuse sweating—a pale colour, bluish lips, rapid pulse, and laboured or rapid breathing.

To treat shock, lie the victim on his/her back and cover with blankets or clothing to keep warm. Elevate the feet about 30 cm higher than the head. Do not give the victim anything to eat or drink. Keep the victim comfortable until help arrives.

Broken bones

A broken bone injury should be immobilised to prevent further injury. Stop bleeding, if there is any, treat for shock and seek medical attention.

Call triple zero (000) in an emergency

ask for ambulance, stay with the person and resuscitate



1 Check for Danger

Ensure safety for yourself, bystanders and casualty.
If safe, remove casualty from water as soon as possible.



2 Check Response

Can you hear me?
Open your eyes.
What's your name?
Squeeze my hand.



3 Send for help NOW call triple zero (000)

Phone for an ambulance.
Remain calm while answering the questions:
- exact location of the incident
- phone number you are calling from
- what has occurred.
Follow the instructions from the ambulance service.



4 Clear Airway

If water or vomit is present in mouth, roll casualty on side, tilt face downwards and clear mouth with your fingers.



5 Check for normal Breathing

Look and feel for rising and falling chest.
Listen and feel for breath sounds.
If the patient is not breathing normally, commence resuscitation.



6 Start Compressions

Adults – place heel of hand in centre of chest. Place other hand on top of first.
Children 1 – 8 years – place heel of hand in centre of chest.
Infants <1 year – place 2 fingers in centre of chest. Compress 1/3 depth of chest. Compress 30 times.

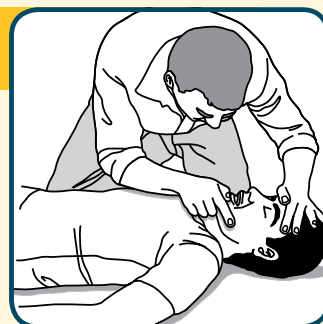

7 Position the airway

Adults and children – tilt head backward. Place one hand on the forehead and use the other hand to lift the chin.
Infants <1 year – do not tilt head. Place one hand on the forehead and use the other hand to support the chin.



8 Start breaths

Adults and children – seal nose and give 2 breaths into mouth.
Infants <1 year – give 2 breaths into mouth and nose. Watch for chest to rise.



9 Repeat breaths & compressions

Repeat 30 chest compressions and 2 breaths.
Continue until ambulance arrives or person regains consciousness or it becomes impossible for you to continue.



10 Attach a Defibrillator as soon as available. Follow the prompts

If injured person shows signs of recovery, roll onto side and check if they are breathing. Reassure the person and bystanders.

Section 5 activities

Activity 1

Prepare emergency response checklists applicable to your own boat for each of the following situations—make sure you include steps that are applicable only to your own boat.

Example:

Abandoning the boat

- Ensure all persons are wearing lifejackets.
- Make appropriate call on the marine radio, to notify rescue authorities of the situation.
- Light a flare if you know it will be seen.
- Activate EPIRB if necessary.
- Assemble all safety equipment that may be needed or useful.
- Keep everyone together and calm.
- Stay with the boat and huddle together. Swim only if close to the shore.

Fire on board

Disabled boat

Person overboard

Activity 2

A person on board your boat has fallen into the cold water and, when retrieved, you believe the person is suffering from hypothermia. What are the main principles in administering first aid to the victim?

Activity 3

List some of the signs a person might show if suffering from heat exhaustion.

1 _____

2 _____

3 _____

4 _____

5 _____

6 _____

Activity 4

What first aid steps would you take for heat exhaustion?

Activity 5

A person on board your boat has fallen unconscious. What do you do?

6.1 Distress signals

There are many widely recognised signals used to indicate distress, including:

- a continuous sounding with any fog-signalling apparatus
- a signal ••• - - - ••• (SOS) in the Morse code
- a mayday call on marine radio
- a red rocket parachute flare or hand flare at night
- an orange smoke signal during day time
- slowly and repeatedly raising and lowering arms
- EPIRB signals
- V-sheet
- dye marker during day time.

The use or exhibition of any of these signals except for the purpose of indicating distress and need of assistance is prohibited. Misuse of them may put the lives of others at risk and is illegal.

6.2 Marine radio



A marine radio transceiver is a vital safety aid, especially for boats travelling offshore. It provides a means of advising marine rescue groups of your itinerary and keeping in contact with them and other boats nearby, checking the weather and receiving navigational warnings. In an emergency, marine radio is your best means of summoning help.

Licences and certificates

Under federal regulations, operators of VHF and MF/HF radios are required to hold an operating certificate; the normal certificate for recreational operators is the Marine Radio Operators Certificate of Proficiency (MROCP). Many Coast Guard and Volunteer Marine Rescue (VMR) stations provide this course or may advise where a local course is available. Operators of 27 MHz equipment are not required to hold a certificate but are strongly encouraged to obtain one. Station (equipment) licences are no longer required for 27 MHz or VHF radios but are still necessary for MF/HF long range radio equipment.



Equipment

Marine radios are essential, and in most cases the only method of communicating with other boats, marine rescue groups and to receive navigational warnings and weather updates. When selecting or using a marine radio there are many factors for you to consider, including:

- the area of operations
- location of local marine rescue groups
- the number of boats in the same area
- your budget
- size and type of boat.

There are four main types of marine communications equipment.

1. VHF – this is the preferred radio for short range communications. All large boats and an increasing number of smaller boats monitor channel 16.

Areas with large boating populations have marine rescue stations monitoring channel 16 and 67 on a 24 hour/7 day basis. Weather information is regularly broadcast on channel 67. Channel 16 is for emergencies or initial calls and should not be used for routine messages or ‘chat’. Most areas throughout Queensland have a local ‘chat’ frequency or a common use rebroadcast frequency.

The local marine rescue station can advise on this practice.



2. 27MHz – these are relatively cheap, easy to operate transceivers and are common in small boats. Their range is essentially ‘line-of-sight’ and they may be subject to interference noise.

Although better than no radio, you should check that a limited coast station is in your immediate vicinity before relying on this equipment for your safety. Most marine rescue groups monitor channel 88 but larger boats at sea do not listen to this radio.

3. HF – these radios have a greater communication range if travelling long distances from shore although they are reliant on atmospheric conditions and to some extent on hull material. They can be difficult to operate without training and practice.

All states and territories operate 24 hour/7 day monitoring on the frequencies 4125, 6215 and 8291 kHz from 'Coast Radio' stations Cairns, Gladstone, Sydney, Melbourne, Adelaide, Hobart, Perth, Port Hedland and Darwin. Queensland HF services cover coastal waters to a minimum of 200 nm seaward from sites located at Cairns (call sign: coast radio Cairns) and Gladstone (call sign: coast radio Gladstone). Weather broadcasts are made on frequency 8176 kHz. Navigational warnings are also broadcast on this frequency at the scheduled times.

All operators should be competent in the operation of radios, know the frequencies dedicated to distress and safety and be able to properly format and transmit distress and safety messages.

4. *Satellite equipment* – although relatively expensive, the range of satellite equipment and telephones provide excellent coverage and are the preferred long range communications device. Training and operator certification are necessary before operating this type of equipment. As the long term future of HF monitoring by coast stations is uncertain, investment in this type of equipment is recommended for boats on off shore voyages.

Over 40 volunteer rescue stations from VMR Point Danger (south) to VMR St Paul's (north) monitor 24 MHz, VHF and HF frequencies. Their hours of operation, frequencies monitored and contact phone numbers are available on the Maritime Safety Queensland website under the 'safety' link.

Operating procedures

Standard radio procedures are used internationally.

Routine calls—logging on and off



Queensland has a large number of volunteer marine stations who, as limited coast stations, provide an invaluable service to the boating public. Boats are strongly encouraged to log on/off with their local station and update changes to location and intentions. Recent fatalities in Queensland highlight the disadvantages of not using this service.

When making a routine call to another vessel or limited coast station, state clearly:

- the boat/group you are calling—(spoken three times if communications are difficult)
- this is — name of your boat—(spoken three times if necessary)
- await a reply/response
- message
- over.

Distress calls

The distress call 'mayday' may be used only if the boat is threatened by grave and imminent danger and immediate assistance is required. For example, the boat is sinking or on fire. This distress call has absolute priority over all other transmissions and may only be transmitted on the authority of the skipper or the person responsible for the safety of the boat. Calls are made on distress frequencies (VHF 16, 27.88 MHz or HF 4125, 6215, 8291 kHz).

Call procedure:

- mayday mayday mayday.
- this is—name and radio call sign of boat in distress—spoken three times.
- mayday
- name and radio call sign of boat
- details of boat's position
- nature of distress and assistance required
- other information including number of people on board, boat description and intentions.

Urgency calls

The urgency call should be used when use of the distress call cannot be justified but a very urgent message concerning the safety of the boat or the safety of a person needs to be transmitted. For example, your boat is disabled and drifting onto a lee shore or a crew member is seriously ill. An urgency call can only be made on the authority of the skipper or person responsible for the safety of the boat. Distress call frequencies (above) may be used for these calls.

Call procedure:

- pan pan, pan pan, pan pan
- hello all stations hello all stations hello all stations
- this is—name and radio call sign of boat—spoken three times
- details of the boat's position
- details of assistance required and other information.

Safety calls

The safety call should be used if you wish to broadcast an important navigational warning to other stations. For example, you have sighted a large floating object that could damage the hull of a boat.

A safety call is more likely to be made by a coast station or a limited coast station operated by a marine rescue group and may include important weather warnings such as severe thunderstorm, gale and cyclone warnings.

Call procedure:

- say-cure-e-tay say-cure-e-tay say-cure-e-tay
- hello all stations hello all stations hello all stations
- this is—name and radio call sign of boat or shore station—spoken three times
- details of the warning.

Initial safety call to all stations can be made on a distress frequency. However, this should be changed to a working frequency for the broadcast of the safety message.

Radio problem checklist

Equipment:

- Is the correct frequency/channel selected?
- Is the volume (AF gain) adjusted correctly?
- Is the squelch adjusted correctly?
- Is the RF gain set to maximum sensitivity?
- Power supply—is the battery fully charged?
- Antenna—are the leads and whip intact, not corroded, have proper earthing and connections in good order?

Procedure:

- Time—is the other station keeping a listening watch?
- Is a silence period in force?
- HF—is the set tuned to the right frequency for the ship's position and time of day?
- Sked times—is the other station busy with a routine broadcast?

If these checks have been completed and there is still no response, another channel or frequency should be tried. Delays may arise because shore station operators are busy on other circuits or handling emergency communications.

In all circumstances, listen before transmitting.

Phonetic alphabet

A—ALPHA	N—NOVEMBER
B—BRAVO	O—OSCAR
C—CHARLIE	P—PAPA
D—DELTA	Q—QUEBEC
E—ECHO	R—ROMEO
F—FOXTROT	S—SIERRA
G—GOLF	T—TANGO
H—HOTEL	U—UNIFORM
I—INDIA	V—VICTOR
J—JULIET	W—WHISKY
K—KILO	X—X-RAY
L—LIMA	Y—YANKEE
M—MIKE	Z—ZULU



6.3 Mobile phones

Although commonly carried on boats, mobile phones can only be considered as a 'back up' device. They should not be seen as a substitute for emergency radio communications because:

- The cellular system does not provide for distress priority alerting.
- Mobile phones may be out of range, have low batteries or become water-damaged.
- Marine radios are used to broadcast so all parties involved in an incident can listen. Mobile phones only call point to point. If you don't know a number, you can't call for assistance even if the boat is in sight.
- Rescue organisations cannot use a radio direction finder to trace a mobile telephone call.
- Few volunteer rescue boats are equipped with mobile phones, resulting in delays (and misinterpretation) while calls are relayed from shore.

In an emergency the most vital link between the rescuers and the rescued is radio communications.

Section 6 activities

Activity 1

What type of marine radios require operator's licences?

Activity 2

List six distress signals you could use to notify others of an emergency situation.

- 1 _____
- 2 _____
- 3 _____
- 4 _____
- 5 _____
- 6 _____

Activity 3

What are the distress calling channels for each of the three radios?

- VHF _____
- HF _____
- 27 MHz _____

Activity 4

For what typical reason would you use:

The international distress call (Mayday)?

The international urgency call (Pan Pan)?

The international safety call (Saycureetay)?

Activity 5

Write out what you would say in a routine call to a volunteer marine rescue group requesting a tow.

Activity 6

List the four main reasons you believe a mobile phone should not be used as a substitute for a marine radio.

- 1 _____
- 2 _____
- 3 _____
- 4 _____

Personal watercraft (PWC) are small, high-powered inboard jet-driven boats, capable of high speeds and radical manoeuvres. The risk of a marine incident or injury to riders, passengers and other water users is dramatically increased due to these factors, particularly if the rider is unaware of the unique characteristics of PWC and is unskilled in their use.

7.1 Licensing

It is compulsory for all PWC operators to hold a personal watercraft licence (PWCL), a separate licence from the recreational marine driver licence (RMDL).

To obtain a PWCL applicants must first hold an RMDL or commercial marine qualification as a master. There is no minimum time required to hold an RMDL before obtaining a PWCL.

All PWCL applicants must undertake a competency-based training program (BoatSafe) for personal watercraft operations before being eligible for a licence.

If you move from interstate, you are required to obtain a PWCL unless you hold an equivalent PWCL issued by another state. Short-term visitors can use their boat licence equivalent, if that is all that is required to operate a PWC in their home state.

You can operate a PWC without a licence only if accompanied by a licensed operator who is able to take immediate control of the craft if required.

A PWC hired from a licensed PWC hirer can sometimes be ridden without a licence under their special restrictions which must be stated before the hirer operates the PWC.

7.2 Preparation

Language



storage for safety equipment and valuables

Types of PWC

There are two main types of PWC:



Performance-orientated PWC (stand-up): Featuring a hinged, adjustable steering column, the rider stands or kneels on a platform at the stern of the boat. These are often used for racing, and require skill and balance to operate. They can accommodate only one rider.



Cruising PWC (sit-astride): The most popular type, accommodating up to four people.

Propulsion

PWC can use either a two-stroke (similar to many outboard motors) or a four-stroke engine (similar to a car engine). The engine drives a powerful water pump which sucks up water from the bottom of the craft through an intake grate. The water passes through an impeller, a type of propeller fitted into a surrounding 'tunnel', which pressurises the water and forces it out a jet nozzle (below) at the rear of the craft.



This jet of pressurised water propels and steers the craft when the throttle is engaged. Some newer PWC include 'off-throttle steering technology' which offers the craft limited manoeuvrability when the throttle is off.

Registration

All PWC must be registered (see p. 16). PWC registration symbols must be:

- displayed on both sides
- at least 100 mm high
- legible from 30 m
- clearly visible in a contrasting colour to your craft
- easily seen while your craft is under way.

The registration label must be displayed on the port side of your craft, near the registration symbols.



7.3 Pre-departure checks

Routine maintenance

Like any other boat, before taking your PWC out on the water, read and understand the owner's manual. Take the time to become familiar with all aspects of your craft.

In the event of breakdown PWC have no alternative propulsion such as oars or sail. It is therefore critical to inspect and maintain the craft to minimise the risk of engine or steering failure. Consult the manufacturer or dealer for a maintenance schedule.



Before launching:

- check inside and under the hull to make sure there are no cracks and excessive wear and tear on the craft, including water leaks
- secure bungs (shown right)
- check steering and throttle for correct operation
- check battery fluid level and charge condition



- check if there is adequate fuel and oil for usage
- check spark plugs and electrical systems for evidence of wear and tear or potential for electrical sparks
- ensure that the intake grate is free of foreign objects
- ensure all compartments and seats are secure.

Check with the manufacturer's user manual to find out if they advise starting the engine before the PWC is launched into the water, and for how long the engine should run.

Fuel

Where possible, fuel your PWC on land rather than on the water to minimise the risk of polluting the waterways and to ensure the PWC is stable. Be responsible by regularly maintaining your fuel system, not overfilling your fuel tank, watching the breathers and using absorbent material to collect fuel overflow. Be sure to refuel in an open, ventilated area where there are no naked flames. Do not over-tighten the fuel cap.



Safety equipment

PWC operators and passengers must wear a lifejacket at all times. The type of lifejacket and other safety equipment for PWC is dependent on where you are travelling. The table, on the next page, outlines the minimum equipment requirement set by legislation, and recommended equipment to satisfy the general safety obligation.

Water limit maps starting on page 26 indicate the three designated water types along the Queensland coast. Consider your entire trip, including areas through which you are only traversing when equipping your PWC.

See page 33 for a description of level 50 and level 50 special purpose lifejackets.

Carry the minimum safety equipment, but to enhance safety, confidence and enjoyment consider carrying safety equipment to cater for the unexpected. For example, consider the following equipment: tow rope, spare bungs, spare lanyard, helmet, gloves and booties.

Lanyard

PWC have either an ignition safety switch (kill switch) or a self-circling feature if the operator falls off.

Most cruising PWC come equipped with an emergency ignition safety switch. This is a safety device which is designed to shut the engine down if the operator is thrown from the proper operating position.

Safety equipment requirements for personal watercraft

Smooth waters	Partially smooth waters	Beyond partially smooth waters
Must carry the following equipment		
Lifejacket	Lifejacket	Lifejacket
Signalling device if operating at night (for example torch, lantern)	Signalling device if operating at night (for example torch, lantern)	Signalling device if operating at night (for example torch, lantern)
	V-sheet *	V-sheet *
	Flares (two red hand-held and two orange smoke) *	Flares (two red hand-held and two orange smoke) *
		EPIRB (406 MHz) ^
Should carry the following equipment		
	Anchor °	Anchor °
	Drinking water	Drinking water
	Chart	Chart
	Compass	Compass
	Handheld electronic navigation device (if not equipped with chart or compass)	Handheld electronic navigation device (if not equipped with chart or compass)

* Does not apply to a PWC that is operating in an approved aquatic event or within 0.5 nm from land.

^ Only applies when more than 2 nm from land or beyond partially smooth waters.

° It is recommended the type and weight of anchor and the length and thickness of the cable should be appropriate for the type and weight of the PWC, the weather and sea conditions and the nature of the seabed.

Note: Pole skis unable to carry the additional safety equipment listed above will be limited to smooth waters, aquatic events or within half a nautical mile from the coast.



The safety switch works by attaching a lanyard between the operator and the switch. It is attached either to the operator's lifejacket (above left) or their wrist (above right). If the lanyard is removed from the switch, then the engine will shut off.

If the operator is thrown from the operating position of a PWC with a self-circling safety feature, the engine will begin running at idle speed while the PWC slowly circles. The operator can then reboard. Be sure that the idle speed is always set correctly, and don't swim after the circling PWC – it will come back to the fall-off position.

Upon reboarding, be sure to re-attach the lanyard or the engine will not start. Always ensure that the lanyard is attached to the licensed operator who is in immediate control of the PWC.

The PWC licence holder is to wear the 'kill switch' safety lanyard, when the PWC is being operated by a learner driver.

Test the lanyard is working before departing on your journey.

Post-operation checks

Check with the manufacturer's user manual or dealer regarding recommended post-operation checks and maintenance. The success of your next trip and durability of your craft will depend on how you treat it after use.

7.4 Manoeuvring

Trailer launching and retrieval

As with other boats, PWC are commonly transferred to the water, launched and retrieved via a trailer (see page 46).

It is possible to launch the PWC by either pushing it from the trailer manually, or if the stern is in sufficient water, applying the reverse lever to manoeuvre the PWC from the trailer under power.

A bow line needs to be attached if the PWC is pushed off manually.

Launching

When launching from a river bank or sand bar, make sure the craft is well clear of other water users such as swimmers, and no swimmers are in the path of the PWC once it has started. Be aware that a PWC puts out a water jet stream up to three metres which can cause injury to persons bathing.

Point the bow of the craft to the centre of the waterway or away from shore into knee deep water (where sand will not be sucked into the intake grate). Rock the craft from side-to-side to free the craft of sand and debris. Attach the lanyard and turn the ignition on.

PWC do not have a neutral gear. Once you start the motor, the craft will move forward. Maintain six knots or below until 60 m from the shore.

Landing

Always allow plenty of room for stopping. Boats do not have brakes! From full speed, PWC can travel up to 80 m after the throttle is released and engine stopped. Practise stopping in the middle of a waterway to find out the stopping characteristics of the PWC, and how much water you will require to land the craft without damage.

The reverse lever (see control at slow speed and reverse) can assist in landing. Those craft without a reverse lever can require a greater stopping distance.

If landing on a beach or sandy shore, turning the engine off before entering shallow water prevents the engine sucking up sand through the intake grate and damaging the impeller.

When beaching the PWC the speed should be not more than six knots within 60 m of shore. A safe PWC operator would travel slower if the area has hazards such as rocks and concrete boat ramps.



Steerage

PWC are jet-driven and do not normally have a conventional rudder. Rather, they have a steering nozzle at the back of the craft which is controlled by the handlebar. This nozzle directs the stream of pressurised water from left to the right. When the steering control is turned right, the steering nozzle is turned right. The force of the water leaving the nozzle pushes the back of the boat to the left, which causes the PWC to turn right.

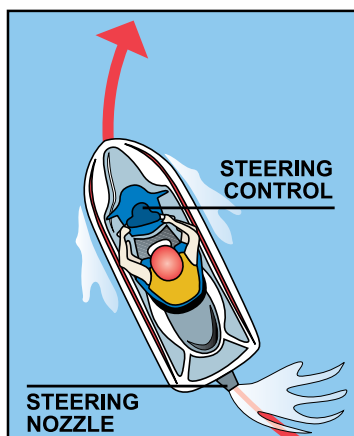

Water conditions (rough, smooth, currents), the rider's body movement, and the number of passengers will all cause the PWC's steering to respond differently.

Most importantly, a PWC must always be under power to maintain control. When the engine is idling or shut-off during operation, all steering control is lost. The PWC will continue in the direction it was headed no matter which way the steering control is turned (some PWC have a limited 'off-throttle' steering control).



This connection between steerage and power is the most critical aspect to understand about operating a PWC and cannot be over-emphasised. Many accidents have occurred when a PWC operator has collided with objects or people after turning off the engine or reducing power.

When confronted with an obstacle, many people's reflex action is to take their thumb off the throttle; however, to take evasive action it is important to retain power and turn to either side. Practise turning at high speed in an open area without other boating traffic.

Safe PWC operators always keep a proper lookout, anticipate hazards and know their boat's capabilities.

Control at slow speed and reverse

Most cruising-style PWC are very stable when stationary or when travelling at slow speed in smooth water. Stand-up craft at slow speed require more coordination and balance on the part of the rider.

The three categories below will help understand how a PWC behaves at different speeds:

Trolling is idle speed when little or no throttle is used. The bow of the PWC is down in the water and there is no wake.



Sub-planing is medium speed. The bow of the PWC is out of the water, but the stern is forced deeper in the water which creates a larger wake.





Planing is a faster speed where the bow and the stern of the PWC are level. The entire craft is skimming on top of the water, which creates a minimal wake.

When trolling or sub-planing, tighter manoeuvring and cornering are possible by ‘feathering’ the throttle (applying the throttle with short, sharp actions) while steering.

Most new model PWC have a reverse thrust to assist low-speed manoeuvring. This is usually operated by a lever on the side of the cowling, which repositions a ‘reverse bucket’ over the jet nozzle, forcing the pressurised water jet to be redirected toward the front of the PWC. This makes the craft move backwards, with the steering assembly determining the direction.

It is important to understand that the reverse lever does not redirect the jet nozzle itself, but repositions the reverse bucket (shown right), redirecting the pressurised water jet. Therefore, the reverse lever should only be applied when the engine is in a slow idle. Doing so at higher speed can damage your craft. Avoid using the reverse lever as a brake.



Once the reverse lever is in place, more speed can then be applied, but most PWC travel at vastly slower speeds in reverse.

The reverse lever (shown being applied below) is useful to assist in manoeuvring a PWC next to other stationary craft, structures such as jetties, when landing, or if picking a person out of the water.



Control at speed

PWC are designed for speed. Turning a PWC at a higher speed is like turning a motorcycle. Reduce speed slightly, turn the handlebars and shift your weight toward the direction of the turn. Apply sufficient throttle to complete the turn. The higher the thrust, the sharper the turn will be. Insufficient or no throttle may cause the PWC to turn slowly or not turn at all, while excessive throttle may cause the PWC to ‘spin out’, causing operator and/or passengers to be thrown from the PWC, or causing possible injury.



Rough water operations

Operating a PWC at high speed in rough conditions, such as in choppy conditions, affects the steering, power and balance of the craft. If, after hitting a small wave, the craft becomes airborne, steering and power will momentarily stop. This will effectively reduce the straight line speed of the craft.

The amount of fuel on board (the average PWC holds around 60 litres) is also a contributing factor to the performance of the craft in such conditions.

It is easy to fall off the PWC in choppy conditions and hard to reboard. Be sensible and reduce speed to match conditions.

Extended high speed operation will affect muscle control in the arms and be exhausting.

Rough water operation should only be conducted by experienced still water operators, and when possible, in the company of a second PWC.

Passenger’s hold

Check with the manufacturer the age and size limits for passengers on your PWC. Your insurance may be void if you don’t follow the instructions.

The safest way a passenger can secure themselves while riding a PWC is to hold the lifejacket of the operator or the person immediately in front of them. Many lifejackets made for PWC have specially designed straps on either side.

Holding onto the handle at the back of the seating can lead to injury of the passenger's arms or back in the event of a capsize or a spin-out.

Before riding at high speed, an operator should familiarise themselves with how the steering of the craft alters when extra passengers are on board. The operator should also brief passengers on the capabilities of the PWC. The operator is responsible for the well-being of the passengers and should ensure all passengers are wearing a suitable lifejacket.

A learner PWC driver cannot carry passengers other than the supervising PWC licence holder.

Freestyling

Freestyling is erratic and non-directional driving, where it is difficult for others to predict your course. High speed manoeuvres such as wake-jumping, donuts, figure 8s, 360s and so on are examples of freestyling. It can be unsafe, annoying and noisy for other water users and nearby residents.

When you are freestyling be aware of other water users. Find a place away from populated areas like beaches and residential areas.

Distance-off laws apply to freestyling PWC operators (see 'Distance and speed' on page 91). PWC operators must obey speed limits (see speed limits on page 63).

If there is more than one craft freestyling in an area, operators should discuss and agree on a direction of operation, for example, anti-clockwise.

Restrictions on where PWC may operate can be found in the *Transport Operations (Maritime Safety) Regulation 2016* on the Maritime Safety Queensland website and waterways management plans and marine zones (see pages 92-93).

Wave jumping and surf riding

Wave jumping and surf riding can be dangerous for inexperienced or careless riders.

Before wave jumping and surf riding check how many other water users are in the vicinity; like swimmers, board riders and other PWC. Operators should also be aware of hazards in the area, such as rocks, jetties and sandbars.

A PWC rider must stay at least 60 m from bathing reserves (for example, flagged areas) and people in the water. It is best to avoid wave jumping in an area where there are swimmers.

Avoid collisions and injuries by thinking carefully before jumping a wave. Note the location of other water users, think about the speed of the craft at take-off, the height of the wave, and approximately where the PWC will land.

When jumping in larger waves, it is often difficult to see board riders or other water users below the crest of the wave. Be aware of sandbars in shallow waters and underneath waves. Make sure there is sufficient water to manoeuvre after the wave has subsided.

Once airborne, it is easy for inexperienced riders of PWC to become separated from their craft. This can lead to serious injury if the rider lands on the PWC itself or a sandbar after a jump of several metres in the air. Injuries from such accidents are common. For this reason, inexperienced riders should first practise jumping at a slower speed over smaller waves, and slowly progress as skill and confidence increase.

When going out to sea, ensure the PWC meets the wave head-on, limiting the chances of rolling or broaching. When returning to shore, ride behind the wave, allowing water beneath the PWC at all times.

Avoid riding the face of a wave with a PWC like a surfboard. If a PWC is caught by the lip of a wave, the craft can broach, leading to significant damage to the craft and rider. Use the throttle generously to avoid the crash zone, but also steer away from shallow water.



Capsizing and righting

Because of a low centre of gravity in their upright position, it is rare for a PWC to remain upturned after capsizing. Most manufacturers of PWC outline how to right the craft in the user's manual. If you roll it over the wrong way, you could cause serious damage to your PWC or to yourself.

The following is a typical way of righting your PWC:

1. Ensure the engine is stopped by removing the engine stop switch or lanyard.
2. Swim to the rear of the PWC and turn it over by gripping the ride plate with your left hand and pushing down on the gunwale rail with your right hand or right foot:
 - do not put your hand in the intake grille
 - take care not to be hit by the PWC as it turns over
 - if in rough water, observe the waves and avoid being near the PWC when waves approach.
3. Reboard the craft, start the engine and head for shore as soon as practicable to inspect the PWC for water damage.

Falling off and reboarding

If you have fallen off in deep water and the engine has cut off, reboard over the back deck (climbing on the side can capsize the PWC). Most PWC have handles on the back of the seating assembly.

Practise reboarding with someone else around to make sure you can handle it alone. Avoid riding when tired or injured as reboarding will be difficult.



Picking up people from the water

Great care should be taken when manoeuvring a PWC near a person in the water, keeping in mind that a jet nozzle can propel water up to three metres behind the craft. Injury can also occur if hair or clothing is caught in the intake grate.

When the person in the water is close enough to swim toward the craft, turn off the engine. The person can then board from the back of the craft.

7.5 On the water

All PWC users must know and abide by the IALA buoyage system, rules of the road, sound signals, navigation lights and local rules (see Chapter 4).

Distance and speed

For your safety and that of everyone else using the water, do not exceed set speed limits. Do not travel at speeds where your wash can cause damage to the shoreline, other boats or injury to others.

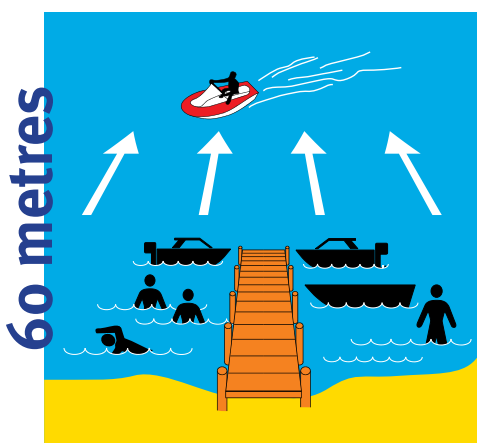

Consider the density of traffic in the area to determine a safe speed. The following distances must be adhered to or reduce speed to 6 knots (= 11 km/h approx) within:

- 60 m from people in the water
- 60 m from anchored or moored boats, boat ramps, jetties or pontoons
- 60 m from shore
- 60 m from boundary of a bathing reserve.

Learn how to judge distance, for example 60 m is 10 m longer than an Olympic-sized swimming pool.



Exceptions apply to '6 knots within 60 m' from the shore under the following conditions:

- the waterway is less than 120 m wide, and
 - the PWC operator is operating the PWC as close as practicable to a straight line to transit the area
 - the PWC operator stays as close as is practicable to the centre of the waterway or a marked channel
- the PWC is being used in waterskiing/towing.

In coastal waters, freestyling or wave jumping is restricted to:

- outside 200 m of the shore if dwellings are within 100 m of the shore line and visible to the operator, and are in the vicinity of the waters where the PWC is operating. Coastal waters do not include dams and non-tidal inland waters.

A PWC driver is to maintain a distance of 30 metres from other moving vessels when travelling more than 10 knots, unless the PWC is involved in an approved aquatic event.

Causes of PWC accidents

Of all boat types registered in Queensland, PWC are involved in the highest percentage of incidents. To reduce the chance of incidents consider the following:

- Do not ride too closely behind another PWC. A sharp turn by the leading PWC can lead to a collision. The rider of the leading PWC can be run over if they fall off.
- Always look over both shoulders before making turns—another boat may be too close behind.
- Do not zig-zag with another PWC at high speed.
- Be aware of traffic in your boating area—don't focus on the short distance ahead.
- Do not reduce power to avoid an object. Keep power applied and turn away.
- Do not ride or jump the wake of boats too closely. On-coming traffic can be obscured from view by the boat, or the boat can stop or change direction suddenly.
- Stop the engine when someone is boarding from the back of the craft.
- Reduce speed significantly in shallow water.

Don't go out alone

Always attempt to ride in pairs, particularly when wave jumping or travelling in open waters. A mechanical breakdown can cause major trouble. A simple twisted wrist can reduce your ability to get yourself back to shore safely.

In cases of real emergencies the second PWC can act as a rescue craft or at least go to get help. Always tell someone who is staying on land where you are going and when you expect to return.

Communications

Most PWC are not capable of carrying a standard marine radio. If travelling long distances or in open waters consider taking either a hand-held VHF radio or a mobile phone.

Waterskiing

As an observer is required, cruising PWC seating two or more can be used for waterskiing. The same rules apply to PWC as to other boats involved in waterskiing (see page 65).



Cleaning jet intake and impeller

The most common cause of breakdown while operating PWC is a blocked impeller. If weeds or debris get caught in the intake or impeller during operation, cavitation can occur. Cavitation is indicated by engine speed rising and, at the same time, forward thrust decreasing. If this condition is allowed to continue the engine will overheat and may seize.

If there is a significant loss of power, take your PWC to shore and check the intake and impeller. Always stop the engine before reaching land.

If at sea, turn your PWC off and sit for at least five seconds and then restart the engine. If the intake is still clogged, stop the engine, dismount and reach under the PWC to remove the obstruction from the intake grate.

Before attempting to remove weeds or debris from the jet intake or impeller areas, shut off the engine and remove the engine lanyard from the stop switch. If this is unsuccessful, return to shore immediately.

Refer to the manufacturer's manual of your own PWC for more detail on clearing the jet intake and impeller of debris.

Courtesy

Riding a PWC safely takes skill and a responsible attitude. Unfortunately some riders believe a PWC can be ridden anywhere and in any fashion without considering the consequences. To gain the most enjoyment from your PWC, ride where you can have fun but don't annoy others.

Don't operate the PWC in a manner that could cause nuisance, annoyance or danger to people in the area. For example, where possible avoid manoeuvres that cause the engine exhaust to lift out of the water because it increases noise levels.

Try to travel in areas where noise will not disturb other people or wildlife. In particular, try not to operate near houses, parks, populated beaches or boat ramps. Avoid shallow areas where wading birds congregate and roost. Remember your behaviour will reflect on all other PWC riders.

Marine zones



Noise and nuisance caused by these craft are the most common complaints about PWC.

In areas where there are a large number of waterside residences, narrow stretches of navigable water and the waterway is used for other low impact activity (swimming, rowing and so on), excluding PWC from these areas through marine zones created under the *Transport Operations (Marine Safety) Regulation 2016*, may be the only feasible way of effectively managing the noise, amenity, safety and environmental impacts created by their use.

Marine zones may be introduced in certain areas throughout the state, limiting a certain type of boat, for example PWC or hovercraft, or a certain type of activity, for example, freestyling, from an area.

Before going out to ride, check whether your intended destination is a marine zone. Information about marine zones is available on the Maritime Safety Queensland website <www.msq.qld.gov.au>. The website also includes information about Waterways Management Plans, which show where freestyling is prohibited on the Gold and Sunshine Coasts.

Also refer to the Department of Environment and Heritage Protection website <www.ehp.qld.gov.au> for information about marine park zones and any other restrictions that may apply in these areas.

In Queensland, PWC have been prohibited in the waters of Tallebudgera Creek since 1997.

Restrictions also apply for certain water-based activities on the Noosa River as part of the new Noosa River Marine Zone. The most significant changes apply to PWC activities, waterskiing, freestyling, hovercraft and airboats.

For more information on the Noosa River Marine Zone visit www.sunshinecoast.qld.gov.au.

Section 7 Activities

Activity 1

What distance must a PWC keep from people in the water when travelling greater than 6 knots?

Activity 2

What safety equipment must you have when using a PWC in open waters?

Activity 3

Why is it important to remember that you must have power to maintain steering control of a PWC?

Activity 4

What types of riding are classified as freestyling?

Activity 5

What is the minimum distance from the shore line at which the operator of a PWC may engage in freestyling?

Activity 6

What is the best way for a passenger to secure themselves while riding a PWC?

Activity 7

What would be the best way to board a PWC after falling off?

Activity 8

What are four things you can do to help avoid an accident on a PWC?

1.

2.

3.

4.

Activity 9

What are marine zones?

8.1 Maritime Safety Queensland office locations

Maritime Safety Queensland has a number of regional offices located throughout the state. To find the contact details for your nearest office visit the Maritime Safety Queensland website.

8.2 Further reading

Getting your licence is only the start of developing your knowledge of boating and the sea. For further information about boating, Maritime Safety Queensland recommends:

Books:

Australian Boating Manual by Captain Dick Gandy

National Powerboating Workbook by Wet Paper Publications

Websites:

www.msq.qld.gov.au	Maritime Safety Queensland
www.bom.gov.au	Bureau of Meteorology
www.amsa.gov.au	Australian Maritime Safety Authority
www.ehp.qld.gov.au	Department of Environment and Heritage Protection
www.boatbooks-aust.com.au	Boat Books