

TMR Accepted Road Safety Barrier Systems and Devices

March 2024



Copyright

© The State of Queensland (Department of Transport and Main Roads) 2024.

Licence



This work is licensed by the State of Queensland (Department of Transport and Main Roads) under a Creative Commons Attribution (CC BY) 4.0 International licence.

CC BY licence summary statement

In essence, you are free to copy, communicate and adapt this work, as long as you attribute the work to the State of Queensland (Department of Transport and Main Roads). To view a copy of this licence, visit: <https://creativecommons.org/licenses/by/4.0/>

Translating and interpreting assistance



The Queensland Government is committed to providing accessible services to Queenslanders from all cultural and linguistic backgrounds. If you have difficulty understanding this publication and need a translator, please call the Translating and Interpreting Service (TIS National) on 13 14 50 and ask them to telephone the Queensland Department of Transport and Main Roads on 13 74 68.

Disclaimer

While every care has been taken in preparing this publication, the State of Queensland accepts no responsibility for decisions or actions taken as a result of any data, information, statement or advice, expressed or implied, contained within. To the best of our knowledge, the content was correct at the time of publishing.

Feedback

Please send your feedback regarding this document to: tmr.techdocs@tmr.qld.gov.au

Contact for enquiries

If you have any questions regarding this document, please contact:

Contact officer Santosh Tripathi
Title Manager (Standards, Research and Training)
Phone 07 3066 8016
Email roaddesignstandards@tmr.qld.gov.au

Amendment Register

Issue/ Rev no.	Reference section	Description of revision	Authorised by	Date
1	Whole	<ul style="list-style-type: none">• First Release	Noel Dwyer	27-Aug-13
2	Whole	<ul style="list-style-type: none">• Introductory Sections amended• Flexfence amended (TL-4)• Armourguard removed• Roadliner 2000S removed• Triton TL-0 removed• Barrierguard 800 Gate added• Armorzone and Triton modified• Supplier contacts amended• Other minor amendments.	Owen Arndt	1 Jul 2014
3	Whole	<ul style="list-style-type: none">• Introductory Sections amended• Added: SMART, Ironman Hybrid• Removed: Brakemaster, Quest, Rubber Crash Cushion• Modified: FLEAT, SKT, ET2000-plus, Quadguard, Zoneguard, Barrierguard 800, T-Lok• Other minor amendments.	Mike Whitehead	Nov 2014

Issue/ Rev no.	Reference section	Description of revision	Authorised by	Date
4	Whole	<ul style="list-style-type: none"> • Supplier contact details amended • HIASA, Ingal MPR and TREND350 added • Quadguard family clarified. Warning added to Quadguard Elite • Crash cushion sheets updated for consistency • Absorb 350 option added to Ironman data sheet • MASH test added to Barrierguard800 • Other minor amendments (Armorzone, Triton, Absorb 350, Triton CET, Sentryline II) • Reference to TRUM note in section on anti-gawk screens updated to MUTCD. 	Owen Arndt	Aug-15
4.1.	Appendices A & B	<ul style="list-style-type: none"> • Boylan and RMS supplier details removed. • Highway Care contact details added / updated. 	-	13 Aug 2015 (V2)
April 2016	Whole	<ul style="list-style-type: none"> • Sections 1.6, 2.1, 3.1 and 3.3 modified. • Minor modifications throughout. • RAMSHIELD added • Ingal MPR accepted on Ezy-Guard SMART. • Deflection tables modified (PCB, JJ Hooks, T-Lok, Ironman, ArmorZone, Triton). • End treatment options updated (JJ Hooks, T-Lok). 	Mike Whitehead	31-Mar-16
June 2016	Whole	<ul style="list-style-type: none"> • Section 3.2 modified. • Valmont supplier details added. • ET2000-plus - MPS variant added. • BG800 LDS - variant added. • Minor amendments throughout. 	Mike Whitehead	24-Jun-16

Issue/ Rev no.	Reference section	Description of revision	Authorised by	Date
November 2016	Whole	<ul style="list-style-type: none"> • Ezy-Guard 4 added. • Sentryline II terminal variant added. • Minor amendments to Ezy-Guard SMART, X-Tension. • W-beam design sheet updated. • Limitations sections in various w-beam end terminal data sheets updated for consistency. 	Mike Whitehead	8-Nov-16
April 2017	Whole	<ul style="list-style-type: none"> • Section 3 renumbered. Section 3.4 TL-0 removed. Sections 3.2 Deflection and 3.3 Footings added. • Minor modifications to single-slope, thrie-beam, modified thrie-beam, w-beam. • Ezy-Guard 4, Ezy-Guard SMART and Ramshield modified to “semi-flexible” sub-category. • Ezy-Guard 4, Ezy-Guard SMART and Ramshield, Brifen, Flexfence and Sentryline-II design, limitations and references updated. • DB80 and ArmorGuard Gate modified. • Quadgard CZ added to Zoneguard. • Minor other revisions throughout. 	Mike Whitehead	27-Apr-17
May 2017	Product Data Sheets	<ul style="list-style-type: none"> • Minor Amendment – removed data sheet for one product listed as ‘under assessment’ 	Daniel Naish	26-May-17
September 2017	Whole	<ul style="list-style-type: none"> • Ezy-Guard High Containment (HC) added. 	Daniel Naish	7-Sep-17
January 2018	Whole	<ul style="list-style-type: none"> • Sentry W-beam added. • Shield I added • Mobile Barriers MBT-1 added • Section 2.3 amended • Section 2.4 added • Ezy-Guard 4 and Ezy-Guard Smart data sheets updated (Surface Mount variant accepted and TL-2 crash test information added) 	Daniel Naish	31-Jan-18
May 2018	Whole	<ul style="list-style-type: none"> • Defender Barrier added. • SMART Cushion – MASH TL-3 crash test information added. • Minor amendments throughout. 	Daniel Naish	18-May-18

Issue/ Rev no.	Reference section	Description of revision	Authorised by	Date
September 2018	Whole	<ul style="list-style-type: none"> • Section 1 amended • New Section 2.5 <i>Guidelines on specifying Barrier Systems in Contracts and Drawings</i> • Section 5 added for listing of products assessed by ASBAP in accordance with AS/NZS 3845.2:2017 • Appendix A updated (Laura Metaal and Innov8 contact details added) • Defender Barrier added • Sentry Median barrier information sheet updated (back-to-back variant added for median use) • BarrierGuard 800 information sheet updated (Laura Metaal & Boylan group added as an owner and supplier respectively) 	Daniel Naish	05-Sep-18
September 2018 (Version 2)	Whole	<ul style="list-style-type: none"> • JL-D-0850 Stuer-Egghe added • J1-LED contact details added 	Daniel Naish	07-Sep-18
February 2019	Whole	<ul style="list-style-type: none"> • MSKT added. • Biker-Shield added. • EzyGuard HC amended. • Defender 100 FS added • Flexfence amended • DB80 amended 	Santosh Tripathi	20-Feb-19
May 2019	Whole	<ul style="list-style-type: none"> • Barrierguard800 rename to BG800 • Armorzone MASH added • Ricochet added • Scorpion II added 	Santosh Tripathi	01-May-19
May 2019 (Version 2)	Whole	<ul style="list-style-type: none"> • Suppliers contact details amended for Armorzone MASH and Armorzone (NCHRP 350) 	Santosh Tripathi	07-May-19

Issue/ Rev no.	Reference section	Description of revision	Authorised by	Date
August 2019	Whole	<ul style="list-style-type: none"> • New barrier added: <ul style="list-style-type: none"> – HV2 • New terminals added: <ul style="list-style-type: none"> – SLED – ET-SS (including terminal cover) – MAX-Tension • Existing product datasheet amended (minor): • Ezy-Guard HC • T-Lok • JJ-Hooks • DB80 • Boylan supplier details removed • TFH Hires Services details added 	Santosh Tripathi	22-Aug-19
December 2019	Whole	<ul style="list-style-type: none"> • New barriers added: <ul style="list-style-type: none"> – SafeZone – HighwayGuard LDS – Lo-Ro Water Cable Barrier • New terminals added: <ul style="list-style-type: none"> – Universal TAU-M – Quadguard M10 • Existing product datasheets amended: <ul style="list-style-type: none"> – PCB – Sentry W Beam – HV2 – BG800 – Armorzone MASH – SLED – X-Tension 350 	Santosh Tripathi	20-Dec-19
June 2020	Whole	<ul style="list-style-type: none"> • New barriers added: <ul style="list-style-type: none"> – Brifen MASH TL3 – Pin and Loop • New terminal added: <ul style="list-style-type: none"> – Absorb-M • New TMA added: <ul style="list-style-type: none"> – SS180M TMA • Existing product datasheets or Section 5 products list amended: <ul style="list-style-type: none"> – Sentry W Beam – Ezy-Guard HC – HighwayGuard – RAMSHIELD W-Beam – SafeZone – Quadguard M10 – MAX-Tension – Scorpion II TMA • Minor amendments throughout 	Santosh Tripathi	08-Jun-20

Issue/ Rev no.	Reference section	Description of revision	Authorised by	Date
November 2020	Whole	<ul style="list-style-type: none"> • New barriers added: <ul style="list-style-type: none"> – Sentryline-M – MashFlex – Sentry Thrie-Beam • New terminal added: <ul style="list-style-type: none"> – Quadguard Elite M10 • Existing product datasheets amended: <ul style="list-style-type: none"> – RAMSHIELD W-Beam – Quadguard-M – ET-SS – PCB – HighwayGuard – Defender Barrier – Lo-Ro Water Cable Barrier – Absorb-M • Section 2.5 updated 	Pooya Saba	06 -Nov-20
April 2021	Whole	<ul style="list-style-type: none"> • Updated product acceptance status for public domain steel barrier systems (Section 4) • Removal of public domain steel barrier systems datasheets (Appendix B) • New barrier added: <ul style="list-style-type: none"> – JJ Hooks MASH • New motorcyclist rubrail added: <ul style="list-style-type: none"> – RiderPro • Existing product datasheets amended: <ul style="list-style-type: none"> – SafeZone – SLED – RAMSHIELD W-Beam – Ezy-Guard SMART – Single Slope Concrete Barrier – Sentryline-M – ET-SS – Absorb-M – PCB – Universal TAU-M – Sentry ThrieBeam – MashFlex – BG800 – HighwayGuard 	Pooya Saba	12-April-21

Issue/ Rev no.	Reference section	Description of revision	Authorised by	Date
September 2021	Whole	<ul style="list-style-type: none"> • Minor updates to Sections 2.5, 3.2, 3.5 and 4 • Section 3.4 ASSHTO Soil Types added • Existing product datasheets amended: <ul style="list-style-type: none"> – Working width data added to all longitudinal barrier product datasheets where available – Minor updates on EDD on all longitudinal barrier product datasheets where applicable – SafeZone – Zoneguard – MSKT – Defender Barrier – RiderPro – Absorb-M – HighwayGuard – Ramshield – DB80 K150 – ET-SS 	Pooya Saba	01-Sep-21
November 2021	Whole	<ul style="list-style-type: none"> • Removal of personally identifiable information in Appendix A • New barriers added: <ul style="list-style-type: none"> – RAMSHIELD HC – Ironman Hybrid MASH • New end treatment added: <ul style="list-style-type: none"> – ArmorBuffa • Existing product datasheets amended: <ul style="list-style-type: none"> – T-LOK – Ezy-Guard SMART – Ezy-Guard 4 – Ezy-Guard HC – HighwayGuard – BG800 – Sentryline-M – Max-Tension 	Pooya Saba	26-Nov-21
January 2022	Whole	<ul style="list-style-type: none"> • Transition to MASH as a default standard • Harmonisation with Austroads TCU • New end treatment added: <ul style="list-style-type: none"> – Hercules • Variation to existing products: <ul style="list-style-type: none"> – HV2 – ET-SS 	Pooya Saba	01-Jan-22

Issue/ Rev no.	Reference section	Description of revision	Authorised by	Date
June 2022	Whole	<ul style="list-style-type: none"> • Variation to existing products: <ul style="list-style-type: none"> – MashFlex – Ezy-Guard HC – Ezy-Guard 4 – Sentry W-Beam – Sentry Thrie-Beam – RamShield W-Beam – RamShield HC • New barriers added: <ul style="list-style-type: none"> – CrocGuard – Rebloc 80SAH_12_8B – Rebloc 80SAH_12 – Ezy-Guard LDS • New products added: <ul style="list-style-type: none"> – Silke MASH 2016 TL3 TMA – Signfix • Austroads TCU Links updated 	Pooya Saba	06-Jun-22
November 2022	Whole	<ul style="list-style-type: none"> • Updated Section 2.2 for reference documents • Updates to Section 2.5 to be consistent with the advice in Drafting and Design Presentation Standards Manual document • All rubrail product datasheets and TCU links removed to harmonise with Austroads • New barriers added: <ul style="list-style-type: none"> – Rebloc 120FA_6_SF – Roller Barrier – Ezy-Guard HD • New sign support structure added: <ul style="list-style-type: none"> – Optimast Sign Support • Variation to existing products: <ul style="list-style-type: none"> – JJ Hooks MASH – HighwayGuard – T-Lok • Minor amendments throughout 	Santosh Tripathi	17-Nov-22
March 2023	Whole	<ul style="list-style-type: none"> • Revised contact email address • Revised Figure 2.5 • New barrier added: <ul style="list-style-type: none"> – Rebloc 80SAH_4 • Variation to existing products: <ul style="list-style-type: none"> – Rebloc 80SAH_12 – Sentry W-Beam – Ezy-Guard LDS – Ezy-Guard HC – Ramshield W-Beam – Ramshield HC – ET-SS – Ingal MPR – Biker-Shield MPD • Minor amendments throughout 	Pooya Saba	15-Mar-23

Issue/ Rev no.	Reference section	Description of revision	Authorised by	Date
August 2023	Whole	<ul style="list-style-type: none"> • New barriers added: <ul style="list-style-type: none"> – T-Lok Rubber – HighwayGuard MDS - Temporary & Permanent • New end treatment added: <ul style="list-style-type: none"> – Trend Median • Variation to existing products: <ul style="list-style-type: none"> – Sentry W Beam – T-Lok F-Type – Ezy-Guard 4 – Ezy-Guard HC – Ezy-Guard HD – Ramshield HC – Ingal Motorcyclist Protection Rail – Safety Roller Barrier • Minor errors rectified on TCU links: <ul style="list-style-type: none"> – SafeZone – Ezy-Guard SMART • Updated registered suppliers • Minor amendments throughout 	Kelli Hansen	18-Aug-2023
March 2024	Whole	<ul style="list-style-type: none"> • Updated Section 2.2 for reference documents • Updated Section 3.3 for anchor removal requirements • New barriers added: <ul style="list-style-type: none"> – DB80A T150S Safety Barrier – ROBOS Flexible Safety Barrier – ROBOS Median Flexible Safety Barrier • New TMA product added: <ul style="list-style-type: none"> – TTMA-200 Trailer Mounted Attenuator • Variation to existing products: <ul style="list-style-type: none"> – SafeZone MDS – SafeZone Standard – Temporary • Removal of legacy non-MASH tested products: <ul style="list-style-type: none"> – X-Tension 350 Median Variant – X-Tension 350 Nose Cone • Minor typo/error rectified on product information: <ul style="list-style-type: none"> – Rebloc 80SAH_12 – Signfix • Updated registered suppliers • Minor amendments throughout 	Santosh Tripathi	22-Mar-2024

Contents

- 1 Introduction 1**
- 1.1 Audience of the document 1
- 1.2 Assessment process 1
- 1.3 Expiry dates 1
- 1.4 Proprietary products 2
- 1.5 Definitions 2
- 2 Standards 2**
- 2.1 Governing manuals, specifications or guidelines 2
- 2.2 Other reference documents 2
- 2.3 Testing and impact parameters 2
- 2.4 Comparing Performance of Systems 3
- 2.5 Guidelines on specifying Barrier Systems in Contracts and Drawings 3
- 3 Other issues 5**
- 3.1 Safety in Design considerations 5
- 3.2 Deflection and working width 5
- 3.3 Footings and anchorages 6
- 3.4 AASHTO soil types 6
- 3.5 Anti-gawk screens 6
- 3.6 Delineation 7
- 3.7 Standing Offer Arrangements 7
- 4 Accepted road safety barriers and devices 7**
- 4.1 Permanent 8
 - 4.1.1 Longitudinal barriers 8
 - 4.1.2 End treatments 12
- 4.2 Temporary 13
 - 4.2.1 Longitudinal barriers 14
 - 4.2.2 End treatments 18
- 4.3 Other road safety devices 19
 - 4.3.1 Gates 19
 - 4.3.2 Miscellaneous 19
- 5 Assessed by ASBAP in Accordance with AS/NZS 3845.2 20**
- 5.1 Longitudinal Channelizing Devices 21
- 5.2 Truck and Trailer Mounted Attenuators 21
- 5.3 Rear Underrun Protection Devices 22
- 5.4 Permanent Bollards 22
- 5.5 Sign Support Structures and Poles 22
- Appendix A – Proprietors, suppliers and industry contacts 23**
- Appendix B – Product information sheets 25**

1 Introduction

This is a controlled document which presents a listing of the road safety barrier systems and devices which:

1. The Department of Transport and Main Roads (the department) has assessed and considers acceptable (subject to appropriate design and installation) for use on the state-controlled road network. Refer to Section 4.
2. The Austroads Safety Barrier Assessment Panel (ASBAP) has assessed and considers acceptable in accordance with AS/NZS 3845.2. Refer to Section 5, noting that systems and devices listed in Section 5 may require additional acceptance from the relevant authoritative sections elsewhere in the department or in other external agencies prior to use.

Users of this document should note that road safety barrier selection and design for both temporary and permanent installations is a complex process frequently requiring risk assessment and the application of engineering judgement. In this regard, Designers are directed towards *Road Planning and Design Manual* 2nd Edition Volume 3 Part 6.

The responsibility remains with the Designer / Principal to confirm the currency of this document.

1.1 Audience of the document

This is a public document.

1.2 Assessment process

The assessment of road safety barrier systems, end treatments and related road safety devices is undertaken by the Austroads Safety Barrier Assessment Panel (ASBAP).

Suppliers (or proponents) seeking acceptance for use on state controlled roads in Queensland of a road safety barrier system, product or device which is not included in this document are referred to the Austroads page ASBAP [Barrier Assessment | Austroads](#) for a digital submission to the ASBAP.

Where an assessment by ASBAP results in a recommendation for acceptance, the recommendation together with any recommended conditions of acceptance is documented by Austroads. This department will be cognisant of the recommendations of the ASBAP process.

Suppliers (or proponents) seeking to use a road safety barrier system, product or device on state controlled roads in Queensland, which is not included in this document, but which has been assessed by ASBAP should submit an application to this department. It should be noted that whilst this department will be cognisant of the recommendations of the Austroads Panel, this department reserves the option to reject, restrict or condition the use of any road safety barrier system, product or device for use on state controlled roads in Queensland.

This department may rescind or modify at any time any product acceptance. This is particularly the case should the status of the acceptance be modified by the Austroads Safety Barrier Assessment Panel or should acceptance be modified in any way in other jurisdictions.

1.3 Expiry dates

The department does not currently specify expiry dates for acceptances.

However, the department may at any time review, rescind or otherwise modify the acceptance of a particular road safety barrier system, product or device.

1.4 Proprietary products

This listing nominates a “Registered Supplier” for each proprietary product. It is a requirement of this department that proprietary products installed on state controlled roads in Queensland are sourced from the nominated recognised supplier (or their agent).

1.5 Definitions

Refer to Australian/New Zealand AS/NZS 3845 and *Road Planning and Design Manual – 2nd Edition* Volume 3.

2 Standards

2.1 Governing manuals, specifications or guidelines

- Australian/New Zealand Standard AS/NZS 3845
- *Manual of Uniform Traffic Control Devices (MUTCD)* (TMR)
- *Road Planning and Design Manual - 2nd Edition* Volume 3 (TMR)
- *Work Health and Safety Act 2011*
- *Work Health and Safety Regulation 2011*
- Technical Specification MRTS14 *Road Furniture* (TMR)
- Technical Specification MRTS02 *Provision for Traffic* (TMR)
- *National Cooperative Highway Research Program Report 350* (NCHRP350) (TRB)
- *Manual for Assessing Safety Hardware (MASH)* (AASHTO)
- *European Standard EN1317* (various parts)

2.2 Other reference documents

- *Roadside Design Guide* 4th Edition (AASHTO)
- *Guide to Road Design Part 6: Roadside Design Safety and Barriers* (Austroads)
- *Safety Barrier Systems and Devices Technical Advice documents* (Austroads) Note: While these technical advice documents are generally accepted by the department, please be aware that departmental manuals and guidelines take precedence over these documents when applied in Queensland.

2.3 Testing and impact parameters

Generally, there are three main crash testing and impact parameter protocols that are adopted. These are (i) the *Manual for Assessing Safety Hardware (MASH)*, and/or (ii) the *National Cooperative Highway Research Program Report 350* (NCHRP350), and/or (iii) the *European Normative EN1317* (EN1317).

This document identifies, where relevant, an Accepted Test Level for most products. Where a particular test protocol has been used to assess a product, the test protocol is noted with the Accepted Test Level. This department may rate a product and/or its variants an Accepted Test Level that is different to a product’s crash test ‘Test Level’ rating or similar rating.

AS/NZS 3845.1 and AS/NZS 3845.2 both state that MASH is the current basis for crash testing protocol.

2.4 Comparing Performance of Systems

Results obtained from crash tests (for example, deflection, working width) conducted under different testing protocols (for example, MASH, NCHRP350, EN1317) that help define the predicted performance of a system cannot be easily compared. Comparisons made on the basis of impact energy are possible, but such comparisons do not result in an equal level of predictable performance that crash tests provide. For example, for non-rigid systems, deflection for a TL-3 system tested to NCHRP350 is not expected to be the same as the deflection of the same TL-3 system tested to MASH because of the differences in impact energy. Additionally, for example, a TL-4 system tested to MASH may reportedly have higher deflection or working width than a TL-4 system tested to NCHRP350, but due to the difference in crash test energy, it is very difficult to make system performance comparisons.

The department advises that designs using a specific accepted system should, in general preferential order, be based on:

- Crash tested system performance data, then, if applicable or desired
- Interpolations or extrapolations away from crash tested system performance data or conditions, which can be based upon any of the following:
 - in-service performance data, and/or
 - research and development testing, and/or
 - engineering simulation.

Any interpolations or extrapolations derived by the system owner are the responsibility of the system owner, and caution should be applied with any use.

2.5 Guidelines on specifying Barrier Systems in Contracts and Drawings

Road safety barrier system drawings are to depict construction details and consider all design elements of the proposed barrier system as determined from a risk evaluation.

The main elements of interest are:

Barrier:

- Containment level
- Length (L)
- Length of need or point(s) of redirection
- Working width or Dynamic deflection (as applicable)
- Motorcyclist Protection Device (MPD).

End treatment:

- Containment level
- Function (gating or non-gating)
- Width (W)
- Length (L)
- Point of redirection (if applicable)

- Taper (if applicable)
- Motorcyclist Protection Device (MPD).

Minimum requirements for drawings

Specific products shall not to be named in design drawings. The design basis, including specific product references, for the verified performance requirements shall be documented in the design development report.

Designers are to specify barrier systems in design drawings as per the following or similar:

"TL-(X) [steel beam / wire rope / concrete] barrier [with MPD] (X)m L"

"TL-(X) [gating / non-gating] end treatment [with MPD] (X)m W (X)m L"

Drawing

- Show control line of barrier system
- Show main elements of interest (for more complex projects show a summary table that details the main elements of interest)
- Show road safety barrier system connection locations
- Show variant locations
- Add relevant notes (such as, design foundation pavement conditions)
- Show other detail (as applicable).

Figure 2.5 – Road safety barrier system – example

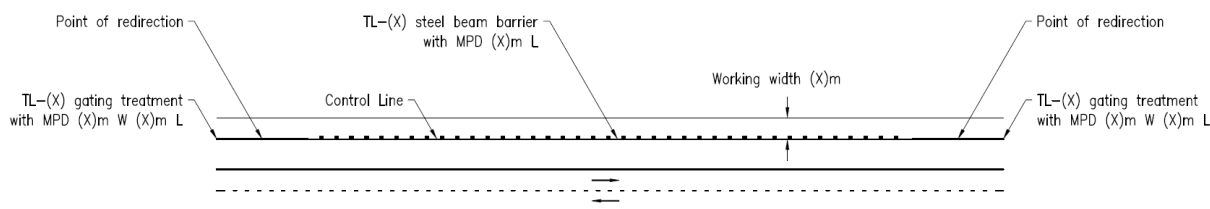

Notes:

1. Foundation pavement conditions to be minimum AASHTO standard soil strength. If pavement construction strength is lower or different refer to TMR Accepted Road Safety Barrier System Devices for options or variants.
2. Point of redirection will be product specific. Refer to TMR Accepted Road Safety Barrier System Devices.

Table 2.5 – Road safety barrier system – Summary table example

ID	Description	Control line	Start chainage	End chainage	Point of redirection ¹	Working width (m)	Variant
1	TL-3 gating end treatment with MP 0.5 m W 16.0 m L	MC01	0	16	Post #3	n/a	n/a
2	TL-3 steel beam barrier with MP 200 m L	MC01	16	216	n/a	1.65	n/a
3	TL-3 steel beam barrier with MP 20 m L	MC01	216	236	n/a	1.65	Base plate installation

ID	Description	Control line	Start chainage	End chainage	Point of redirection ¹	Working width (m)	Variant
4	TL-3 steel beam barrier with MP 50 m L	MC01	236	286	n/a	1.65	n/a
5	TL-3 gating end treatment with MP 0.5 m W 16.0 m L	MC01	286	302	Post #3	n/a	n/a

Note: ¹ Point of redirection will be product specific.

3 Other issues

3.1 Safety in Design considerations

The *Work Health and Safety Act 2011* and *Work Health and Safety Regulation 2011* impose requirements on certain duty holders. Road safety barrier hardware (permanent and temporary) present risks to the health or safety of persons who may be required to carry out any construction work. Such risks may be particularly pertinent to temporary devices but may also apply to permanent devices. Such risks may include (but not necessarily be limited to):

- Fragments or debris expelled during impact.
- Excess deflection or failure of a system or device to adequately contain an impacting vehicle.
- Means of access over, through or around a system or device.
- Residual energy stored in devices (especially post-impact).

3.2 Deflection and working width

Working width from impacts into barriers should be used to identify the possible intrusion into the area behind a barrier. Working width is measured from the outermost extremity on the traffic side, regardless of shape, to the furthest extremity of any part of the system or vehicle during and after the impact. Designers are recommended to adopt the largest working width value for the nominated containment level based on crash testing as per the department's accepted product datasheet or obtain from product owners.

Deflection values reported in this document are typically those reported during crash testing performed under controlled conditions. Where the hazard is low enough that it does not interfere with the possible vehicle intrusion into the area behind a barrier (for example, batter), dynamic deflection is considered sufficient. Designers should be cognisant of the type of hazard(s) and the risk of vehicle and/or barrier intruding behind the barrier before deciding to use deflection value in lieu of working width. Designers are encouraged to check with product owners that these values are correct before proceeding to select site-specific design deflections. Designers need to be cognisant that the crash test deflection value is a single data point, and that in-service performance may be expected to vary.

For further information, see Section 5.5.2 of *Austrroads Guide to Road Design Part 6*.

Typical working width measurements are illustrated in Figure 3.2.

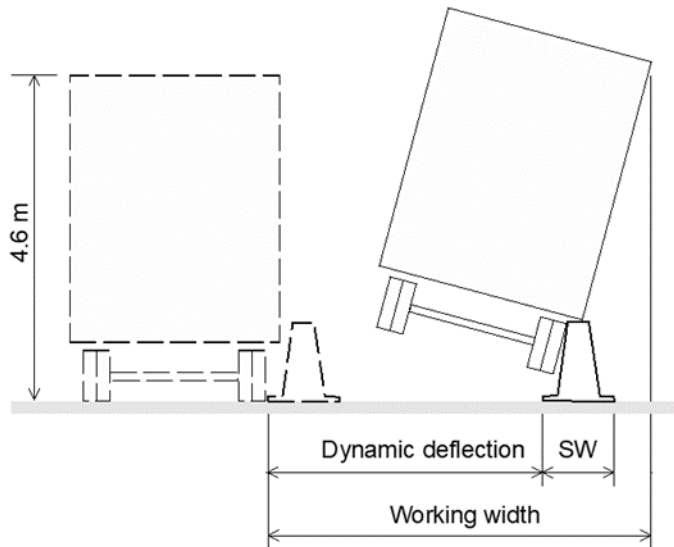
Figure 3.2 – Working width measurements showing dynamic deflection, system width (SW)

Legend: SW = System width

Source: ASBAP (2020a) Technical Advice 20-002

3.3 Footings and anchorages

The person (the Designer) specifying any system relying on the resistance provided by the ground to function needs to be satisfied that the design is adequate to meet the intended level of performance for the site specific context and ground conditions. This may necessitate for example demonstration by calculation or otherwise that the proposed footing or anchorage is at least equivalent to that used during the compliance testing in order to adequately resist lateral or longitudinal displacement as well as rotation or pull-out.

The anchors of temporary road safety barriers shall be fully removed from the work site after the designated installation period, and then the pavement surface with anchor holes shall be reinstated as per MRTS02.

3.4 AASHTO soil types

The barrier needs to resist the loads from an impacting vehicle and this action requires the soil strength to be commensurate with the strength of the soil used in testing under the MASH protocol (AASHTO). This is often an AASHTO standard soil, which is a well compacted granular soil with a CBR (California Bearing Ratio) of approximately 60. Some barriers have been tested in a MASH weak soil, which is categorised as the finer aggregate or sand that is used in concrete. The CBR for weak soils is judged to be between 8 and 10.

Refer Austroads *Guide to Road Design* Part 6 for further advice.

3.5 Anti-gawk screens

The department does not maintain a list of accepted anti-gawk (or anti-debris) screens. Guidance pertaining to anti-gawk screens is provided in Section 5.3.3 of the Part 3 of the Austroads *Guide to Temporary Traffic Management*.

The provisions for attachments to barriers is discussed in Australian/New Zealand Standard AS/NZS 3845.1 Clause 2.5.5, which states (among other things):

"There shall be no attachment to a road safety barrier system unless it can be shown by crash testing or by assessment as a modification ... that it is suitable."

Anti-gawk screens are considered to be an attachment to a road safety barrier system and as such are subject to the above provisions of the Standard. Wherever full scale crash testing is not provided then assessment (as required by AS/NZS 3845.1) is required. Such an assessment would need as a minimum to address, among other things, the provisions of AS/NZS 3845.1.

Thereafter, a second engineering assessment is required to determine whether any road safety barrier and associated anti-gawk screen is appropriate for use at a site-specific project location.

In any impact event, it is likely that some elements of the screen attachment will be displaced and will enter the workzone. Practitioners prescribing the use of anti-gawk screens should be cognisant of the consequent increase in risk to workers. Refer Section 3.1.

3.6 Delineation

Nose delineation for road safety barrier terminals, including crash cushions should be provided in accordance with the *Manual of Uniform Traffic Control Devices*.

3.7 Standing Offer Arrangements

There are a number of suppliers listed by the department for supply of road safety barrier systems and their components in QLD. Please refer to the department's current [Standing Offer Arrangement](#) (SOA) and [Registered Suppliers List](#) on the department website.

4 Accepted road safety barriers and devices

Non-MASH tested safety barrier systems and devices must not be used on new projects or installations within the departmental road network, unless specified in this document. This change aligns Queensland with other Australian states and territories and complies with AS/NZS 3845. Non-MASH tested products can be used for the purposes of maintaining existing installations when repairs and replacements can be reasonably and readily undertaken based on remaining service life, or if justified and certified by an RPEQ as an exception for new installations.

If a project was already financially approved, funded or commenced based on non-MASH products that were current at the time prior to 1 January 2022, there is no expectation that proprietary products have to be applied.

If a project is still in design, every effort should be made to provide MASH compliant barriers.

Temporary barrier systems and devices manufactured prior to 1 January 2022 can continue to be used until the end of their useful service life. Temporary barrier systems and devices manufactured after 1 January 2022 shall meet MASH guidelines.



For further information on this change view the [FAQs](#) and [Decision Tree](#).





Transport and Main Roads product datasheets are replaced by Austroads Technical Conditions of Use (TCU), where appropriate. Where multiple revisions of TCU are issued by Austroads, the version specified and linked in this document shall be considered as a Transport and Main Roads accepted version at the time of publication of this document.

Where the department has explicit conditions, they will be specified in this document. The department may also decide to accept a product that is not on the ASBAP list and may maintain the datasheet provided in Appendix B.



4.1 Permanent

4.1.1 Longitudinal barriers



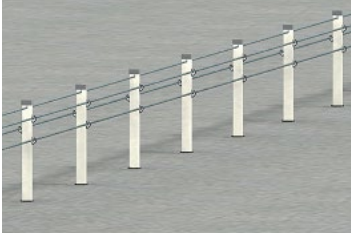

<p><u>Single Slope Concrete Barrier</u> <i>Type:</i> Concrete (rigid) <i>Accepted Test Level:</i> MASH TL-1 TL-2 TL-3 TL-4 TL-5 TL-6 NCHRP350 TL-1 TL-2 TL-3 TL-4 TL-5 TL-6 <i>Registered Supplier:</i> Public Domain <i>Notes:</i> Test Level subject to height and configuration. Refer to Departmental Standard Drawing 1468. <i>Austrroads TCU:</i> Nil. <i>TMR Conditions:</i> Refer to datasheet in Appendix B.</p>	
<p><u>Ezy-Guard 4</u> <i>Type:</i> Steel beam <i>Accepted Test Level:</i> MASH TL-1 TL-2 TL-3 TL-4 TL-5 TL-6 <i>Registered Supplier:</i> Ingal Civil Products <i>Austrroads TCU:</i> 1 June 2023 <i>TMR Conditions:</i> Ezy-Guard 4 may be able to connect to departmental public domain concrete barrier (Standard Drawing 1470) using Ingal RBT rigid barrier transition with necessary modification works. Contact the supplier for confirmation and modification details. The following variants should be limited to constrained locations under Extended Design Domain:</p> <ul style="list-style-type: none"> • Base plate installation • Ezy-Lift • Single 6m clear span 	
<p><u>Ezy-Guard SMART</u> <i>Type:</i> Steel beam <i>Accepted Test Level:</i> MASH TL-1 TL-2 TL-3 TL-4 TL-5 TL-6 <i>Registered Supplier:</i> Ingal Civil Products <i>Austrroads TCU:</i> 15 September 2022 <i>TMR Conditions:</i> The following variants should be limited to constrained locations under Extended Design Domain:</p> <ul style="list-style-type: none"> • Base plate installation • Ezy-Lift • 1 metre post spacing 	
<p><u>Ezy-Guard Heavy Duty (HD)</u> <i>Type:</i> Steel beam <i>Accepted Test Level:</i> MASH TL-1 TL-2 TL-3 TL-4 TL-5 TL-6 <i>Registered Supplier:</i> Ingal Civil Products <i>Austrroads TCU:</i> 2 March 2023 <i>TMR Conditions:</i> Nil.</p>	







<p><u>Ezy-Guard High Containment (HC)</u> <i>Type:</i> Steel beam <i>Accepted Test Level:</i> MASH TL-1 TL-2 TL-3 TL-4 TL-5 TL-6 <i>Registered Supplier:</i> Ingal Civil Products <i>Austrroads TCU:</i> 1 June 2023 <i>TMR Conditions:</i> Ezy-Guard HC may be able to connect to departmental public domain concrete barrier (Standard Drawing 1470) using Ingal RBT rigid barrier transition with necessary modification works. Contact the supplier for confirmation and modification details. The following variants should be limited to constrained locations under Extended Design Domain:</p> <ul style="list-style-type: none"> • Base plate installation • Single post omission 	
<p><u>Ezy-Guard Low Deflection System (LDS)</u> <i>Type:</i> Steel beam <i>Accepted Test Level:</i> MASH TL-1 TL-2 TL-3 TL-4 TL-5 TL-6 <i>Registered Supplier:</i> Ingal Civil Products <i>Austrroads TCU:</i> 15 December 2022 <i>TMR Conditions:</i> The following variant should be limited to constrained locations under Extended Design Domain:</p> <ul style="list-style-type: none"> • Installation on 1:1 batter hinge point (TL-3 only) 	
<p><u>RAMSHIELD W-Beam</u> <i>Type:</i> Steel beam <i>Accepted Test Level:</i> MASH TL-1 TL-2 TL-3 TL-4 TL-5 TL-6 <i>Registered Supplier:</i> Safe Direction <i>Austrroads TCU:</i> 15 September 2022 <i>TMR Conditions:</i> The following variants should be limited to constrained locations under Extended Design Domain:</p> <ul style="list-style-type: none"> • Single 6 metre clear span • Base plate installation • 1 metre post spacing 	
<p><u>RAMSHIELD High Containment (HC)</u> <i>Type:</i> Steel beam <i>Accepted Test Level:</i> MASH TL-1 TL-2 TL-3 TL-4 TL-5 TL-6 <i>Registered Supplier:</i> Safe Direction <i>Austrroads TCU:</i> 1 June 2023 <i>TMR Conditions:</i> The following variant should be limited to constrained locations under Extended Design Domain:</p> <ul style="list-style-type: none"> • RAMSHIELD Edge • Base plate installation 	

<p><u>Sentry W-Beam</u> <i>Type:</i> Steel beam <i>Accepted Test Level:</i> MASH TL-1 TL-2 TL-3 TL-4 TL-5 TL-6 <i>Registered Supplier:</i> Safe Direction <i>Austrroads TCU:</i> 20 March 2023 <i>TMR Conditions:</i> The following variants should be limited to constrained locations under Extended Design Domain:</p> <ul style="list-style-type: none"> • Back to back installation • Base plate installation – may only be installed on concrete foundation pavements • Installation in weak soil • 1 metre post spacing 	
<p><u>Sentry Thrie-Beam</u> <i>Type:</i> Steel beam <i>Accepted Test Level:</i> MASH TL-1 TL-2 TL-3 TL-4 TL-5 TL-6 <i>Registered Supplier:</i> Safe Direction <i>Austrroads TCU:</i> 14 March 2022 <i>TMR Conditions:</i> The following variant should be limited to constrained locations under Extended Design Domain:</p> <ul style="list-style-type: none"> • Base plate installation 	
<p><u>CrocGuard Safety Barrier</u> <i>Type:</i> Steel beam <i>Accepted Test Level:</i> MASH TL-1 TL-2 TL-3 TL-4 TL-5 TL-6 <i>Registered Supplier:</i> Safe Direction <i>Austrroads TCU:</i> 9 June 2022 <i>TMR Conditions:</i> Nil.</p>	
<p><u>Safety Roller Barrier</u> <i>Type:</i> Steel beam <i>Accepted Test Level:</i> MASH TL-1 TL-2 TL-3 TL-4 TL-5 TL-6 <i>Registered Supplier:</i> Ambient Technologies <i>Austrroads TCU:</i> 4 April 2023 <i>TMR Conditions:</i> Nil.</p>	
<p><u>Brifen MASH TL-3</u> <i>Type:</i> Wire Rope <i>Accepted Test Level:</i> MASH TL-1 TL-2 TL-3 TL-4 TL-5 TL-6 <i>Registered Supplier:</i> Safe Direction Pty Ltd <i>Notes:</i> Brifen MASH TL3 requires Brifen MASH TL3 End Terminal. <i>Austrroads TCU:</i> 20 November 2020 <i>TMR Conditions:</i> Nil.</p>	

<p><u>MashFlex</u> <i>Type:</i> Wire Rope <i>Accepted Test Level:</i> MASH TL-1 TL-2 TL-3 TL-4 TL-5 TL-6 <i>Registered Supplier:</i> Ingal Civil Products <i>Notes:</i> MashFlex requires MashFlex Terminal. <i>Austrads TCU:</i> 14 March 2022 <i>TMR Conditions:</i> The following variants should be limited to constrained locations under Extended Design Domain:</p> <ul style="list-style-type: none"> • Driven post sleeve • Base plate installation 	
<p><u>Sentryline-M</u> <i>Type:</i> Wire Rope <i>Accepted Test Level:</i> MASH TL-1 TL-2 TL-3 TL-4 TL-5 TL-6 <i>Registered Supplier:</i> Safe Direction <i>Notes:</i> Sentryline-M requires Sentryline-M Wire Rope Terminal End TL-3. <i>Austrads TCU:</i> 3 September 2021 <i>TMR Conditions:</i> The following variants should be limited to constrained locations under Extended Design Domain:</p> <ul style="list-style-type: none"> • Driven post sleeve (TL-3) • Base plate installation • Anchor foundation block, dimension: 3.4m L x 1.5m W x 0.74m D • Anchor foundation block, dimension: 3.4m L x 1.0m W x 1.0m D 	
<p><u>ROBOS</u> <i>Type:</i> Steel Strap (Flexible) <i>Accepted Test Level:</i> MASH TL-1 TL-2 TL-3 TL-4 TL-5 TL-6 <i>Registered Supplier:</i> Hiway Stabilisers Australia <i>Notes:</i> ROBOS requires ROBOS 4-Strap Terminal. <i>Austrads TCU:</i> 13 September 2023 <i>TMR Conditions:</i> Nil.</p>	
<p><u>ROBOS Median</u> <i>Type:</i> Steel Strap (Flexible) <i>Accepted Test Level:</i> MASH TL-1 TL-2 TL-3 TL-4 TL-5 TL-6 <i>Registered Supplier:</i> Hiway Stabilisers Australia <i>Notes:</i> ROBOS requires ROBOS 8-Strap Terminal. <i>Austrads TCU:</i> 13 September 2023 <i>TMR Conditions:</i> Nil.</p>	

4.1.2 End treatments

<p>ET-SS <i>Type:</i> Gating (TL-2: Redirective from 2nd Post; TL-3: Redirective from 3rd Post) <i>Accepted Test Level:</i> MASH TL-1 TL-2 TL-3 TL-4 TL-5 TL-6 <i>Registered Supplier:</i> Ingal Civil Products <i>Notes:</i> Tangential / Flared; Extruder Head. <i>Austroads TCU:</i> 1 December 2022 <i>TMR Conditions:</i> The following variants should be limited to constrained locations under Extended Design Domain:</p> <ul style="list-style-type: none"> • Alternative anchor post foundation • Baseplated post 	
<p>ET-SS Terminal Cover <i>Type:</i> Extruder Head Cover <i>Accepted Test Level:</i> MASH Not rated. <i>Registered Supplier:</i> Ingal Civil Products <i>Austroads TCU:</i> Nil. <i>TMR Conditions:</i> Nil.</p>	
<p>MSKT <i>Type:</i> Gating (Redirective from 3rd Post) <i>Accepted Test Level:</i> MASH TL-1 TL-2 TL-3 TL-4 TL-5 TL-6 <i>Registered Supplier:</i> Safe Direction <i>Notes:</i> Tangential / Flared; Extruder Head. (MSKT = <u>M</u>ash <u>S</u>equential <u>K</u>inking <u>T</u>erminal). <i>Austroads TCU:</i> 7 June 2021 <i>TMR Conditions:</i> Nil.</p>	
<p>MAX-Tension <i>Type:</i> Gating (TL-2: Redirective at 1st Post; TL-3: Redirective 2860 mm downstream from 1st Post) <i>Accepted Test Level:</i> MASH TL-1 TL-2 TL-3 TL-4 TL-5 TL-6 <i>Registered Supplier:</i> Safe Direction <i>Notes:</i> Tension / friction based. <i>Austroads TCU:</i> 20 November 2020 <i>TMR Conditions:</i> Nil.</p>	
<p>MAX-Tension Motorcyclist Delineation Cover <i>Type:</i> Extruder Head Cover <i>Accepted Test Level:</i> MASH Not rated. <i>Registered Supplier:</i> Safe Direction <i>Austroads TCU:</i> Nil. <i>TMR Conditions:</i> Nil.</p>	



<p><u>Trend Median Terminal</u> <i>Type:</i> Gating (Redirective from 3rd Post) <i>Accepted Test Level:</i> MASH TL-1 TL-2 TL-3 TL-4 TL-5 TL-6 <i>Registered Supplier:</i> Ingal Civil Products <i>Austroads TCU:</i> 24 March 2023 <i>TMR Conditions:</i> Nil.</p>	
<p><u>QUADGUARD M10</u> <i>Type:</i> Redirective Crash Cushion <i>Accepted Test Level:</i> MASH TL-1 TL-2 TL-3 TL-4 TL-5 TL-6 <i>Registered Supplier:</i> Ingal Civil Products <i>Austroads TCU:</i> QUADGUARD M10 - Permanent: 4 March 2021 QUADGUARD M10 CZ - Temporary: 6 September 2021 <i>TMR Conditions:</i> Nil.</p>	
<p><u>QUADGUARD Elite M10</u> <i>Type:</i> Redirective Crash Cushion <i>Accepted Test Level:</i> MASH TL-1 TL-2 TL-3 TL-4 TL-5 TL-6 <i>Registered Supplier:</i> Ingal Civil Products <i>Austroads TCU:</i> 18 December 2020 <i>TMR Conditions:</i> Nil.</p>	
<p><u>Smart Cushion</u> <i>Type:</i> Redirective Crash Cushion <i>Accepted Test Level:</i> MASH TL-1 TL-2 TL-3 TL-4 TL-5 TL-6 <i>Registered Supplier:</i> LB Australia <i>Austroads TCU:</i> 5 December 2020 <i>TMR Conditions:</i> Nil.</p>	
<p><u>Universal TAU-M</u> <i>Type:</i> Redirective Crash Cushion <i>Accepted Test Level:</i> MASH TL-1 TL-2 TL-3 TL-4 TL-5 TL-6 <i>Registered Supplier:</i> Safe Direction <i>Austroads TCU:</i> 4 March 2021 <i>TMR Conditions:</i> Nil.</p>	
<p><u>Hercules</u> <i>Type:</i> Redirective Crash Cushion <i>Accepted Test Level:</i> MASH TL-1 TL-2 TL-3 TL-4 TL-5 TL-6 <i>Registered Supplier:</i> Safe Direction <i>Austroads TCU:</i> 3 September 2021 <i>TMR Conditions:</i> Nil.</p>	



4.2 Temporary





Note that temporary roadside barrier systems and devices manufactured:







- Prior to 1 January 2022 can continue to be used until the end of their service life.
- After 1 January 2022 should meet MASH guidelines.



4.2.1 Longitudinal barriers

<p>Precast Concrete Barrier (PCB) <i>Type:</i> Temporary Concrete Barrier – Single Slope <i>Accepted Test Level:</i> MASH Not rated. NCHRP350 TL-1 TL-2 TL-3 TL-4 TL-5 TL-6 <i>Registered Supplier:</i> Public Domain <i>Notes:</i> Departmental Standard Drawings 1473 and 1458. Has a permanent configuration option, refer departmental Standard Drawing 1473. Photo shows example of anti-gawk screen attached. <i>Austrroads TCU:</i> Nil. <i>TMR Conditions:</i> Refer to datasheet in Appendix B.</p>	
<p>DB80 K150 Precast Concrete Barrier <i>Type:</i> Temporary Concrete Barrier – F Shape <i>Accepted Test Level:</i> MASH TL-1 TL-2 TL-3 TL-4 TL-5 TL-6 <i>Registered Supplier:</i> Jaybro Group Pty Ltd <i>Austrroads TCU:</i> 20 July 2021 <i>TMR Conditions:</i> This F shape temporary concrete barrier is only acceptable for use on roads with speed limits of 80 km/h or less.</p>	
<p>DB80 T150S Precast Concrete Barrier <i>Type:</i> Temporary Concrete Barrier – F Shape <i>Accepted Test Level:</i> MASH TL-1 TL-2 TL-3 TL-4 TL-5 TL-6 <i>Registered Supplier:</i> Jaybro Group Pty Ltd <i>Austrroads TCU:</i> 20 December 2021 <i>TMR Conditions:</i> This F shape temporary concrete barrier is only acceptable for use on roads with speed limits of 80 km/h or less.</p>	
<p>DB80A T150S Precast Concrete Barrier <i>Type:</i> Temporary Concrete Barrier – F Shape <i>Accepted Test Level:</i> MASH TL-1 TL-2 TL-3 TL-4 TL-5 TL-6 <i>Registered Supplier:</i> Jaybro Group Pty Ltd <i>Austrroads TCU:</i> 1 December 2022 <i>TMR Conditions:</i> This F shape temporary concrete barrier is only acceptable for use on roads with speed limits of 80 km/h or less.</p>	
<p>JJ Hooks MASH Precast Concrete Barrier <i>Type:</i> Temporary Concrete Barrier – F Shape <i>Accepted Test Level:</i> MASH TL-1 TL-2 TL-3 TL-4 TL-5 TL-6 <i>Registered Supplier:</i> Australian Road Barriers <i>Austrroads TCU:</i> 3.6 Metre Barrier Unit: 14 March 2022 6 Metre Barrier Unit: 14 March 2022 <i>TMR Conditions:</i> This F shape temporary concrete barrier is acceptable for use only on roads with speed limits of 80 km/h or less.</p>	

<p><u>T-LOK Precast Concrete Barrier</u> <i>Type:</i> Temporary Concrete Barrier – F Shape <i>Accepted Test Level:</i> MASH TL-1 TL-2 TL-3 TL-4 TL-5 TL-6 <i>Registered Supplier:</i> Saferoads <i>Austrroads TCU:</i> 1 June 2023 <i>TMR Conditions:</i> This F shape temporary concrete barrier is acceptable for use only on roads with speed limits of 80 km/h or less. The Bespoke Wedge is accepted for use where the speed limit is restricted to 60 km/h or less.</p>	
<p><u>T-LOK Rubber Precast Concrete Barrier</u> <i>Type:</i> Temporary Concrete Barrier – F Shape <i>Accepted Test Level:</i> MASH TL-1 TL-2 TL-3 TL-4 TL-5 TL-6 <i>Registered Supplier:</i> Saferoads <i>Austrroads TCU:</i> 1 June 2023 <i>TMR Conditions:</i> This F shape temporary concrete barrier is acceptable for use only on roads with speed limits of 80 km/h or less. The Bespoke Wedge is accepted for use where the speed limit is restricted to 60 km/h or less.</p>	
<p><u>Pin and Loop Precast Concrete Barrier</u> <i>Type:</i> Temporary Concrete Barrier – F Shape <i>Accepted Test Level:</i> MASH TL-1 TL-2 TL-3 TL-4 TL-5 TL-6 <i>Registered Supplier:</i> Pin and Loop Pty Ltd <i>Austrroads TCU:</i> 1 December 2021 <i>TMR Conditions:</i> This F shape temporary concrete barrier is acceptable for use only on roads with speed limits of 80 km/h or less.</p>	
<p><u>BG800</u> <i>Type:</i> Temporary Steel Barrier <i>Accepted Test Level:</i> MASH TL-1 TL-2 TL-3 TL-4 TL-5 TL-6 <i>Registered Supplier:</i> Ingal Civil Products <i>Austrroads TCU:</i> BG800 Standard - Permanent: 1 December 2021 BG800 Standard - Temporary: 1 December 2021 BG800 MDS - Permanent: 1 December 2021 BG800 MDS - Temporary: 1 December 2021 BG800 LDS - Temporary: 1 December 2021 <i>TMR Conditions:</i> Nil.</p>	
<p><u>HighwayGuard</u> <i>Type:</i> Temporary Steel Barrier <i>Accepted Test Level:</i> MASH TL-1 TL-2 TL-3 TL-4 TL-5 TL-6 <i>Registered Supplier:</i> Ingal Civil Products <i>Austrroads TCU:</i> HighwayGuard Standard - Temporary: 8 September 2022 HighwayGuard LDS - Permanent: 1 December 2021 HighwayGuard LDS - Temporary: 1 December 2021 HighwayGuard MDS - Permanent (TL-3): 1 June 2023 HighwayGuard MDS - Temporary (TL-3): 1 June 2023 <i>TMR Conditions:</i> Nil.</p>	



<p><u>Defender Barrier</u> <i>Type:</i> Temporary Steel Barrier <i>Accepted Test Level:</i> MASH TL-1 TL-2 TL-3 TL-4 TL-5 TL-6 <i>Registered Supplier:</i> Safe Barriers Pty. Ltd. <i>Austroads TCU:</i> Defender Barrier 70: 1 December 2021 Defender Barrier 100 LDS: 3 September 2021 Defender Barrier 100 HC: 3 September 2021 Defender Barrier 100 FS: 1 December 2021 <i>TMR Conditions:</i> Nil.</p>	
<p><u>SafeZone</u> <i>Type:</i> Temporary Steel Barrier <i>Accepted Test Level:</i> MASH TL-1 TL-2 TL-3 TL-4 TL-5 TL-6 <i>Registered Supplier:</i> Jaybro Group Pty Ltd <i>Austroads TCU:</i> SafeZone Standard - Temporary: 23 October 2023 SafeZone Standard - Permanent: 21 June 2022 SafeZone LDS - Temporary: 21 June 2022 SafeZone LDS - Permanent: 21 June 2022 SafeZone MDS - Permanent & Temporary: 1 September 2023 <i>TMR Conditions:</i> Nil.</p>	
<p><u>IronMan Hybrid MASH</u> <i>Type:</i> Temporary Steel Barrier <i>Accepted Test Level:</i> MASH TL-1 TL-2 TL-3 TL-4 TL-5 TL-6 <i>Registered Supplier:</i> Saferoads <i>Austroads TCU:</i> 17 September 2021 <i>TMR Conditions:</i> Nil.</p>	
<p><u>Zoneguard</u> <i>Type:</i> Temporary Steel Barrier <i>Accepted Test Level:</i> MASH TL-1 TL-2 TL-3 TL-4 TL-5 TL-6 <i>Registered Supplier:</i> Hill & Smith <i>Austroads TCU:</i> Zoneguard Standard: 8 December 2021 Zoneguard MDS: 4 March 2021 <i>TMR Conditions:</i> Nil.</p>	
<p><u>HV2</u> <i>Type:</i> Temporary Steel Barrier <i>Accepted Test Level:</i> MASH TL-1 TL-2 TL-3 TL-4 TL-5 TL-6 <i>Registered Supplier:</i> Saferoads Pty Ltd <i>Austroads TCU:</i> 1 December 2021 <i>TMR Conditions:</i> Nil.</p>	

<p>ArmorZone MASH <i>Type:</i> Temporary Plastic Water Filled Device <i>Accepted Test Level:</i> MASH TL-1 TL-2 TL-3 TL-4 TL-5 TL-6 <i>Registered Supplier:</i> Ingal Civil Products <i>Austrroads TCU:</i> 20 November 2020 <i>TMR Conditions:</i> Nil.</p>	
<p>Ricochet <i>Type:</i> Temporary Plastic Water Filled Device <i>Accepted Test Level:</i> MASH TL-1 TL-2 TL-3 TL-4 TL-5 TL-6 <i>Registered Supplier:</i> TFH Hire Services <i>Austrroads TCU:</i> 20 November 2020 <i>TMR Conditions:</i> Nil.</p>	
<p>Lo-Ro Water Cable Barrier <i>Type:</i> Temporary Plastic Water Filled Device <i>Accepted Test Level:</i> MASH TL-1 TL-2 TL-3 TL-4 TL-5 TL-6 <i>Registered Supplier:</i> Jaybro Group Pty Ltd <i>Austrroads TCU:</i> 20 November 2020 <i>TMR Conditions:</i> Nil.</p>	
<p>Shield I <i>Type:</i> Temporary Plastic Water Filled Device <i>Accepted Test Level:</i> MASH TL-1 TL-2 TL-3 TL-4 TL-5 TL-6 <i>Registered Supplier:</i> National Plastic Group <i>Austrroads TCU:</i> 20 November 2020 <i>TMR Conditions:</i> Nil.</p>	
<p>Mobile Barriers MBT-1 <i>Type:</i> Temporary Workzone Protection Device <i>Accepted Test Level:</i> MASH TL-1 TL-2 TL-3 TL-4 TL-5 TL-6 <i>Registered Supplier:</i> Mobile Barriers <i>Austrroads TCU:</i> 20 November 2020 <i>TMR Conditions:</i> Nil.</p>	
<p>Rebloc 80SAH 12 <i>Type:</i> Freestanding Precast Concrete Safety Barrier <i>Accepted Test Level:</i> MASH TL-1 TL-2 TL-3 TL-4 TL-5 TL-6 <i>Registered Supplier:</i> Hill & Smith <i>Austrroads TCU:</i> 2 September 2022 <i>TMR Conditions:</i> Nil.</p>	
<p>Rebloc 80SAH 12 8B <i>Type:</i> Anchored Precast Concrete Safety Barrier <i>Accepted Test Level:</i> MASH TL-1 TL-2 TL-3 TL-4 TL-5 TL-6 <i>Registered Supplier:</i> Hill & Smith <i>Austrroads TCU:</i> 22 March 2022 <i>TMR Conditions:</i> Nil.</p>	

<p>Rebloc 80SAH 4 <i>Type:</i> Freestanding Precast Concrete Safety Barriers <i>Accepted Test Level:</i> MASH TL-1 TL-2 TL-3 TL-4 TL-5 TL-6 <i>Registered Supplier:</i> Hill & Smith <i>Austroads TCU:</i> 1 December 2022 <i>TMR Conditions:</i> Nil.</p>	
<p>Rebloc 120FA 6 SF <i>Type:</i> Freestanding Precast Concrete Safety Barrier <i>Accepted Test Level:</i> MASH TL-1 TL-2 TL-3 TL-4 TL-5 TL-6 <i>Registered Supplier:</i> Hill & Smith <i>Austroads TCU:</i> 16 June 2022 <i>TMR Conditions:</i> This F shape temporary concrete barrier is acceptable for use only on roads with speed limits of 80 km/h or less.</p>	

4.2.2 End treatments

Some permanent crash cushions as listed above may be suitable for connection to temporary barrier systems. Designer should consult system supplier to verify compatibility between systems.

<p>Absorb-M <i>Type:</i> Water Filled, Non-Redirective, Gating Plastic Terminal <i>Accepted Test Level:</i> MASH TL-1 TL-2 TL-3 TL-4 TL-5 TL-6 <i>Registered Supplier:</i> Safe Direction <i>Austroads TCU:</i> 7 June 2021 <i>TMR Conditions:</i> Nil.</p>	
<p>ArmorBuffa <i>Type:</i> Non-Redirective, Gating Plastic Water Filled End Treatment <i>Accepted Test Level:</i> MASH TL-1 TL-2 TL-3 TL-4 TL-5 TL-6 <i>Registered Supplier:</i> Ingal Civil Products <i>Austroads TCU:</i> 3 September 2021 <i>TMR Conditions:</i> Nil.</p>	
<p>SLED <i>Type:</i> Non-Redirective, Gating Plastic Water Filled End Treatment <i>Accepted Test Level:</i> MASH TL-1 TL-2 TL-3 TL-4 TL-5 TL-6 <i>Registered Supplier:</i> Saferoads Pty Ltd <i>Austroads TCU:</i> 5 December 2020 <i>TMR Conditions:</i> Nil.</p>	

4.3 Other road safety devices

4.3.1 Gates

<p><u>ARMORGUARD Gate</u> <i>Type:</i> Gate <i>Accepted Test Level:</i> MASH TL-1 TL-2 TL-3 TL-4 TL-5 TL-6 NCHRP350 TL-1 TL-2 TL-3 TL-4 TL-5 TL-6 <i>Registered Supplier:</i> Safe Direction <i>Austrroads TCU:</i> Nil. <i>TMR Conditions:</i> Refer to datasheet in Appendix B.</p>	
<p><u>BG800 Steel Gate</u> <i>Type:</i> Gate <i>Accepted Test Level:</i> MASH TL-1 TL-2 TL-3 TL-4 TL-5 TL-6 NCHRP350 TL-1 TL-2 TL-3 TL-4 TL-5 TL-6 <i>Registered Supplier:</i> Ingal Civil Products <i>Austrroads TCU:</i> Nil. <i>TMR Conditions:</i> Refer to datasheet in Appendix B.</p>	

4.3.2 Miscellaneous

<p><u>Biker-Shield Motorcyclist Protection Device</u> <i>Type:</i> Motorcyclist Rubrail <i>Accepted Test Level:</i> MASH N/A <i>Registered Supplier:</i> Safe Direction <i>Austrroads TCU:</i> Nil. <i>Accepted Compatible Barrier:</i> RAMSHIELD W-Beam, RAMSHIELD HC, Public Domain W-Beam <i>TMR Conditions:</i> Nil.</p>	
<p><u>HIASA Rail Motorcyclist Protection Device</u> <i>Type:</i> Motorcyclist Rubrail <i>Accepted Test Level:</i> MASH N/A <i>Registered Supplier:</i> Safe Direction <i>Austrroads TCU:</i> Nil. <i>Accepted Compatible Barrier:</i> Public Domain W-Beam <i>TMR Conditions:</i> Nil.</p>	
<p><u>Ingal Motorcyclist Protection Rail</u> <i>Type:</i> Motorcyclist Rubrail <i>Accepted Test Level:</i> MASH N/A <i>Registered Supplier:</i> Ingal Civil Products <i>Austrroads TCU:</i> Nil. <i>Accepted Compatible Barrier:</i> Public Domain W-Beam, Ezy-Guard SMART, Ezy-Guard 4, Ezy-Guard HC, Ezy-Guard LDS, Ezy-Guard HD <i>TMR Conditions:</i> Nil.</p>	

<p><u>RiderPro Motorcyclist Protection Device</u> <u>Type:</u> Motorcyclist Rubrail <u>Accepted Test Level:</u> MASH N/A <u>Registered Supplier:</u> Safe Direction <u>Austrads TCU:</u> Nil. <u>Accepted Compatible Barrier:</u> Sentry W-Beam, Sentry Thrie-Beam, Public Domain W-Beam (permitted with RiderPro MP variant only) <u>TMR Conditions:</u> Nil.</p>	
<p><u>RAPTOR</u> <u>Type:</u> Pole Cushion <u>Accepted Test Level:</u> MASH TL-1 TL-2 TL-3 TL-4 TL-5 TL-6 <u>Registered Supplier:</u> Valmont Highway <u>Austrads TCU:</u> 1 December 2021 <u>TMR Conditions:</u> Nil.</p>	
<p><u>“Safe Direction” Plastic Blockout</u> <u>Type:</u> Blockout <u>Accepted Test Level:</u> MASH N/A <u>Registered Supplier:</u> Safe Direction <u>Austrads TCU:</u> Nil. <u>TMR Conditions:</u> For use in selected terminals only. Approval for use of plastic blocks on Public Domain W-beam guardrail strong posts was withdrawn in March 2008. Plastic blocks remain accepted for use in respective proprietary terminals. Designer to consult with supplier.</p>	<p>No picture</p>
<p><u>“Ingal” Plastic Blockout</u> <u>Type:</u> Blockout <u>Accepted Test Level:</u> MASH N/A <u>Registered Supplier:</u> Ingal Civil Products <u>Austrads TCU:</u> Nil. <u>TMR Conditions:</u> For use in selected terminals only. Approval for use of plastic blocks on Public Domain W-beam guardrail strong posts was withdrawn in March 2008. Plastic blocks remain accepted for use in respective proprietary terminals. Designer to consult with supplier.</p>	<p>No picture</p>

5 Assessed by ASBAP in Accordance with AS/NZS 3845.2

The products in this list have been assessed and accepted by ASBAP in accordance with AS/NZS 3845.2. Products listed here have only been assessed in accordance with AS/NZS 3845.2, and there are other approvals that are required elsewhere in the department or in other external agencies prior to use. **In other words, a product listed here is not approved for use, but approved for its assessment in accordance with AS/NZS 3845.2 only.**

In summary, among other things, AS/NZS 3845.2 primarily only assesses a products suitability from a crashworthiness perspective. Any other aspects of a product are not specifically reviewed by ASBAP.

Important Notes:

1. It is NOT the intention of the list below to imply that other products are not acceptable for use by Transport and Main Roads and cannot be used operationally by the department.
2. Operators are recommended to select devices which are fit for purpose to their total requirements. Crashworthiness is just one aspect to consider.
3. Operators are recommended to select products that are suitable to their business needs. The evolving list below may be used as a guide in this regard.





5.1 Longitudinal Channelizing Devices





Nil.

5.2 Truck and Trailer Mounted Attenuators

Note that Truck or Trailer mounted Attenuators (TMAs) manufactured:

- Prior to 1 January 2022 can continue to be used until the end of their service life.
- After 1 January 2022 should meet MASH guidelines.

<p>BLADE <i>Type:</i> Truck Mounted Attenuator <i>Accepted Test Level:</i> MASH TL-1 TL-2 TL-3 TL-4 TL-5 TL-6 <i>Austrroads TCU:</i> 5 December 2020 <i>TMR Conditions:</i> Nil. <i>Registered Supplier:</i> Innov8 Equipment Pty Ltd</p>	
<p>JL-D-0850 Stuer-Egghe "Julietta" <i>Type:</i> Truck Mounted Attenuator <i>Accepted Test Level:</i> MASH TL-1 TL-2 TL-3 TL-4 TL-5 TL-6 NCHRP350 TL-1 TL-2 TL-3 TL-4 TL-5 TL-6 <i>Austrroads TCU:</i> 20 November 2020 <i>TMR Conditions:</i> Nil. <i>Registered Supplier:</i> J1-LED</p>	
<p>Scorpion II <i>Type 1:</i> Truck Mounted Attenuator <i>Accepted Test Level:</i> MASH TL-1 TL-2 TL-3 TL-4 TL-5 TL-6 <i>Austrroads TCU:</i> 20 November 2020 <i>TMR Conditions:</i> Nil.</p> <p><i>Type 2:</i> Truck Mounted Attenuator <i>Accepted Test Level:</i> MASH TL-1 TL-2 TL-3 TL-4 TL-5 TL-6 <i>Austrroads TCU:</i> 20 November 2020 <i>TMR Conditions:</i> Nil.</p> <p><i>Type 3:</i> Trailer Mounted Attenuator <i>Accepted Test Level:</i> MASH TL-1 TL-2 TL-3 TL-4 TL-5 TL-6 <i>Austrroads TCU:</i> 20 November 2020 <i>TMR Conditions:</i> Nil. <i>Registered Supplier:</i> A1 Roadlines Pty Ltd</p>	  

<p>SS180M <i>Type:</i> Truck Mounted Attenuator <i>Accepted Test Level:</i> MASH TL-1 TL-2 TL-3 TL-4 TL-5 TL-6 <i>Austrads TCU:</i> 20 November 2020 <i>TMR Conditions:</i> Nil. <i>Registered Supplier:</i> Ingal Civil Products</p>	
<p>Silke MASH TMA <i>Type:</i> Truck Mounted Attenuator <i>Accepted Test Level:</i> MASH TL-1 TL-2 TL-3 TL-4 TL-5 TL-6 <i>Austrads TCU:</i> 22 March 2022 <i>TMR Conditions:</i> Nil. <i>Registered Supplier:</i> J1-LED</p>	
<p>TTMA-200 Trailer Mounted Attenuator <i>Type:</i> Trailer Mounted Attenuator <i>Accepted Test Level:</i> MASH TL-1 TL-2 TL-3 TL-4 TL-5 TL-6 <i>Austrads TCU:</i> 21 March 2021 <i>TMR Conditions:</i> Nil. <i>Registered Supplier:</i> Ambient Technologies</p>	
<p>5.3 Rear Underrun Protection Devices</p> <p>Nil.</p>	
<p>5.4 Permanent Bollards</p> <p>Nil.</p>	
<p>5.5 Sign Support Structures and Poles</p>	
<p>Signfix Sign Support <i>Type:</i> Sign Support Structure <i>Accepted Test Level:</i> MASH TL-1 TL-2 TL-3 TL-4 TL-5 TL-6 <i>Austrads TCU:</i> 20 December 2021 <i>TMR Conditions:</i> Nil. <i>Registered Supplier:</i> Delnorth Group</p>	
<p>Optimast Sign Support <i>Type:</i> Sign Support Structure <i>Accepted Test Level:</i> MASH TL-1 TL-2 TL-3 TL-4 TL-5 TL-6 <i>Austrads TCU:</i> 20 December 2021 <i>TMR Conditions:</i> Nil. <i>Registered Supplier:</i> Delnorth Group</p>	

Appendix A – Proprietors, suppliers and industry contacts**(Subject to change without notice)**

<u><i>A1 Roadlines Pty Ltd</i></u>	89 Rushdale Street, Knoxfield, VIC 3180 Ph: 1300 217 623 www.a1roadlines.com.au Email: sales@a1roadlines.com.au
<u><i>Advantage Plastics</i></u>	254 Easterbrook Road, RD1 Kaiapoi 7691, NZ Ph: +64 33135750 Fax: +64 33106036 www.advantageplastics.co.nz Email: info@adplasz.com
<u><i>Ambient Technologies Pty Ltd</i></u>	24 Eakins Cres, Geraldton, WA 6530 www.ambienttechnologies.com.au Email: weaties@midwesttraffic.com.au
<u><i>Australian Road Barriers</i></u>	17 Old Creswick Rd, Wendouree, VIC 3355 Ph: 1800 003 826 www.roadbarriers.com.au Email: sales@roadbarriers.com.au
<u><i>Delnorth Group</i></u>	63 Bonville Avenue, Thornton NSW 2322 www.signfix.com.au Email: sales@signfix.com.au
<u><i>Highway Care International</i></u>	The Highlands, Detling, Maidstone, Kent, ME14 3HT, United Kingdom www.highwaycareint.com
<u><i>Hill & Smith</i></u>	1/242 New Cleveland Rd, Tingalpa, QLD 4173 Ph: 1300 277 683 www.hsroads.com.au Email: sales@hsroads.com.au
<u><i>Ingal Civil Products</i></u>	7 Nestor Drive, Meadowbrook, QLD 4131 Ph: 07 3489 9120 Fax: 07 3489 9130 www.ingalcivil.com.au Email: sales@ingalcivil.com.au
<u><i>Innov8 Equipment Pty Ltd</i></u>	86 Mulgoa Road Penrith NSW 2750 Ph: 1300 071 007 www.innov8equipment.com.au Email: sales@innov8equipment.com.au
<u><i>Jaybro Group Pty Ltd</i></u>	29 Penelope Crescent, Arndell Park, NSW 2148 Ph: 1300 885 364 www.jaybro.com.au Email: sales@Jaybro.com.au
<u><i>J1-LED</i></u>	10 Production Street, Beenleigh QLD 4207 Ph: 07 3807 6272 www.j1led.com Email: info@j1led.com

<u><i>Laura Metaal Road Safety PTY Limited</i></u>	L11 1 Margaret Street, Sydney, NSW 2000 Ph: +31 88 9996400 www.laurametaal.com Email: apac@laurametaal.nl
<u><i>LB Australia</i></u>	Unit 6/79, Mandoon Road, Girraween, NSW 2145 Ph: 1300 522 878 www.lbaustralia.com.au Email: roadsafety@lbaustralia.com.au
<u><i>Mobile Barriers</i></u>	24918 Genesee Trail Road, Golden, Colorado 80401, USA. Ph: +1 303 526 5995 http://int.mobilebarriers.com/ Email: ana.sales@mobilebarriers.com
<u><i>National Plastic Group</i></u>	5 Christensen Road, Staplyton QLD 4207 Ph: 1800 677 003 www.nationalplasticsgroup.com.au Email: info@barriersystems.com.au
<u><i>Pin and Loop Pty Ltd</i></u>	63-69 High Street Queanbeyan NSW 2620 Ph: 02 6297 1611 www.precastconcrete.com.au Email: admin@precastconcrete.com.au
<u><i>Saferoads</i></u>	22 Commercial Drive, Pakenham, VIC. 3810 Ph: 1800 060 072 www.saferoads.com.au Email: sales@saferoads.com.au
<u><i>Safe Direction</i></u>	47 Telford Circuitb, Yatala, QLD 4207 Ph. 1300 063 220 www.safedirection.com.au Email: sales@safedirection.com.au
<u><i>Safe Barriers</i></u>	Suite 54, 29 Smith Street Parramatta, NSW 2150 www.safebarriers.com Email: info@safebarriers.com
<u><i>TFH Hire Services</i></u>	8-14 Eurora Street, Kingston, QLD 4114 Ph: 1300 834 834 Email: sales@tfh.com.au
<u><i>Valmont Highway</i></u>	57-65 Airds Road, Minto, NSW 2566 Ph: +61 400366351 www.valmonthighway.com Email: info@valmonthighway.com

Appendix B – Product information sheets

(Information Only)

1. Single Slope Concrete Barrier
2. Precast Concrete Barrier (PCB)
3. Armorguard Gate
4. BarrierGuard 800 Steel Gate

Department of Transport and Main Roads

Road Safety Barrier Systems and End Treatments: Product Information Sheet

This information sheet shall be, where relevant, read in conjunction with the manufacturer's latest manual.

Single Slope Concrete Barrier

TMR Standard Drawing 1468

Created: Monday, 21 August 2023

8:47 AM

Page 1 of 2

Status*: Accepted

* TMR reserves the right to alter the Status and Status Expiry Date at any time. Always refer to latest version of TMR's Road Safety Barrier Systems and End Treatments document.

Status Commencement Date: Not Set

Status Expiry Date*: Not Set

Category: Longitudinal

Gating/Non-Gating: Not Applicable

Sub Category: Rigid

Redirective/Non-Redirective: Redirective

Main Material: Concrete

Permanent/Temporary: Permanent

Ownership:

Public Domain

Supplier:

Public Domain

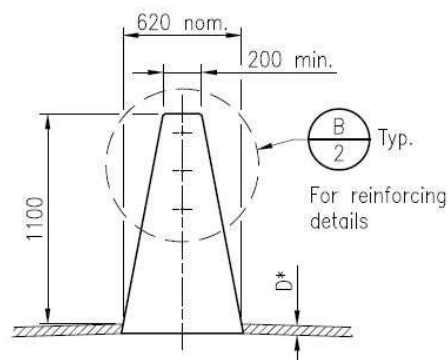

Introduction:

The single slope barrier is a rigid extruded reinforced concrete barrier with a 10.8° profile. Heights may vary.

AASHTO Roadside Design Guide (2011) (section 6.4.1.8) states "Concrete barrier shapes that meet the NCHRP Report 350 criteria are the New Jersey and F-shapes, the single-slope barrier (two variations in slope), and the vertical wall. These shapes, when adequately designed and reinforced may all be considered TL-4 designs at the standard height of 813mm and TL-5 designs at heights of 1067mm and higher".

An advantage of the single slope shape is that it can accommodate adjacent overlays without compromising the profile of the barrier. However, designers do need to be cognisant that overlays will reduce the effective height of the barrier and hence reduce its overall containment capacity.

Test Level:

Extruded Variant

Deemed to meet NCHRP 350 TL-5 (1100mm high, anchored) (based on AASHTO Roadside Design Guide (2011) and FHWA memorandum HMHS-B64 dt. 14-Feb-2000).

Refer to TMR Standard Drawing 1468 for further guidance on containment level.

PCB: Pre-cast variant

- Refer to Precast Concrete Barrier (PCB) data sheet
- Permanent configurations for PCB shown on TMR Standard Drawing 1473

Recommended End Treatments:

Any accepted permanent crash cushion (refer this document), with appropriate transition/connection. Alternatively, it is acceptable to transition to steel-beam barrier end terminal via transition (see TMR standard drawings).

Design:

Standard configurations of single slope extruded barrier are provided on TMR Standard Drawing 1468.

Whilst TMR Standard Drawing 1468 nominates the single slope barrier as a median barrier, it may be used at other locations. In order to maintain the specified containment capacity, adequate footing restraint must be provided to resist overturning and lateral deflection.

The minimum lengths of barrier nominated on TMR Standard Drawing 1468 apply to lengths between gaps provided for street lighting and/or expansion joints.

Where there is a risk that the end of a concrete barrier can be impacted, the end must be shielded by one of:

- (i) an accepted connection to another barrier system,
- (ii) a suitable method of overlap,
- (iii) an accepted crashworthy crash cushion.

Overlays (or lift or corrector) courses placed after initial construction of the barrier may reduce the relative/residual height of barriers and/or their profile. Designers should make provision for such future treatments when designing a barrier.

Deflection:

Whilst this barrier type is “rigid” and should exhibit zero deflection under impact, designers should be cognisant of the possibility of vehicle roll and working width when locating objects mounted on or situated behind the barrier.

Limitations:

Refer to TMR Standard Drawing 1468.

Designers and project managers should be cognisant that provision of lighting within barriers introduces some additional exposure to risk:

- (i) Street lighting poles are likely to exist within the working width envelope.
- (ii) Steel cover plates shown on standard Drawing 1469 are not expected to provide test level TL-5 containment capability.

Such design decisions should be documented in the design documentation.

References:

- AS/NZS 3845
- NCHRP Report 350
- TMR Road Planning and Design Manual
- Standard Drawing 1468
- Roadside Design Guide (AASHTO, 2011)
- FHWA memorandum HMHS-B64 dt. 14-Feb-2000).

Department of Transport and Main Roads

Road Safety Barrier Systems and End Treatments: Product Information Sheet

This information sheet shall be, where relevant, read in conjunction with the manufacturer's latest manual.

Precast Concrete Barrier (PCB)

TMR Standard Drawing 1473

Created: Monday, 21 August 2023

8:47 AM

Page 1 of 2

Status*: Accepted

* TMR reserves the right to alter the Status and Status Expiry Date at any time. Always refer to latest version of TMR's Road Safety Barrier Systems and End Treatments document.

Status Commencement Date: Not Set

Status Expiry Date*: Not Set

Category: Longitudinal

Gating/Non-Gating: Not Applicable

Sub Category: Semi-Rigid

Redirective/Non-Redirective: Redirective

Main Material: Concrete

Permanent/Temporary: Permanent or Temporary

Ownership:

Public Domain

Supplier:

Various

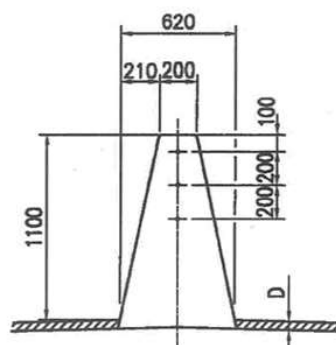

Introduction:

The Precast Concrete Barrier (PCB) is a concrete barrier with a single-slope profile.

Test Level:

Deemed to meet the requirements of NCHRP report 350 test level TL-3 when properly connected in accordance with QTMR standard drawing 1473.

Useful Product Data:

Unit length	-	7250mm
Unit width (base)	-	620mm
Unit height	-	1050mm

Note limitations regarding lifting: seek latest advice from TMR Structures Branch

Recommended End Treatments:

Quadguard CZ; TAU II; Triton CET (<=70km/h); SLED (<=80km/h); Absorb 350 (<=70km/h): (requires transition in concrete barrier to maximum height of 812mm); Absorb-M (<=80km/h)

Precast Concrete Barrier (PCB)

Design:

Minimum Length: 36 m

Recommended Minimum Radius: R150m

Interaction with Kerbs

- In unrestrained configurations, the system cannot be placed adjacent to kerbs or other objects within the deflection limits of the barrier that may prevent lateral displacement.

End Treatments:

- A proprietary end treatment should be installed wherever any risk exists that the blunt end could be impacted.
- Any proprietary end treatment system must be specifically designed or adapted for use with "single slope" shape barrier and must be installed and maintained strictly in accordance with the manufacturer's instructions.
- Barrier flare rate should not exceed 1:10.

Vehicle Roll:

- Where the hazard being protected by a barrier extends above the height of the barrier the Designer should ensure that adequate separation from the face of the barrier to the hazard is provided to allow for the roll of high vehicles (such as trucks) hitting the hazard.

Deflection:

Deflection (Normal Design Domain):

Measured (Crash Test) Deflections:

Nominal Mass (kg)	Nominal Angle (deg)	Nominal Speed (km/h)	Recorded Deflection (m)	Note
2000	15	100	0.18	1
2000	15	100	0.15	2

Notes:

1. Beason et al (1989) test ref. 9429C-1, 36.4m installation (4 x 9.1m units)
2. Beason et al (1989) test ref. 9429K-1, 54.6m installation (6 x 9.1m units)

Actual clearance distance to workzone should be determined by risk assessment prior to installation.

Designers are recommended to adopt the largest working width / deflection value for the nominated containment level.

Limitations:

- Refer TMR std. dwg. 1473 [Check for currency of revision].
- Placement of barriers and effects on surface drainage are to be considered.

Maintenance:

- Inspect units for damage after impact. Damaged units to be replaced.

References:

- Australian Standard AS/NZS 3845
- NCHRP Report 350
- TMR Road Planning and Design Manual
- Main Roads Standard Drawing 1473 (rev. F)
- Beason et al (1989) Development of a Single Slope Concrete Median Barrier, TTI
- Barrier Systems Inc letter dated 23 March 2004
- Email correspondence on SLED transition to PCB (Saferoads, 18 December 2019)

Department of Transport and Main Roads

Road Safety Barrier Systems and End Treatments: Product Information Sheet

This information sheet shall be, where relevant, read in conjunction with the manufacturer's latest manual.

Armorguard Gate

Created: Monday, 21 August 2023

8:47 AM

Page 1 of 2

Status*: Accepted

* TMR reserves the right to alter the Status and Status Expiry Date at any time. Always refer to latest version of TMR's Road Safety Barrier Systems and End Treatments document.

Status Commencement Date: Not Set

Status Expiry Date*: Not Set

Category: Longitudinal

Gating/Non-Gating: Not Applicable

Sub Category: Semi-Rigid

Redirective/Non-Redirective: Redirective

Main Material: Steel

Permanent/Temporary: Permanent

Ownership:

Barrier Systems
3333 Vaca Valley Pkwy, Ste. 800, Vacaville, CA 95688, USA
www.barriersystemsinc.com

Supplier:

Safe Direction
47 Telford Circuit, Yatala, QLD 4207
Ph. 1300 063 220
www.safedirection.com.au



Introduction:

Armorguard Gate is a hinged steel barrier "gate" to span between permanent openings in concrete barrier.



Test Level:

NCHRP Report 350 TL-3

Recommended End Treatments:

No end treatment as the gate is embedded into longitudinal barrier system.

Armorguard Gate

Design:

May only be installed in a maximum total opening of 16m, including hinge sections.

Deflection:

Measured (Crash Test) Deflections:

Nominal Mass (kg)	Nominal Angle (deg)	Nominal Speed (km/h)	Recorded Deflection (m)	Note
2,000	25	100	0.57	1

Note:

1 = NCHRP 350 3-21

Limitations:

May only be installed in a gap in rigid concrete barrier.

References:

- Australian Standard AS/NZS 3845
- NCHRP Report 350
- TMR Road Planning and Design Manual
- NSW RMS Acceptance Document dated 03/08/2013
- FHWA letter Ref: HSA-10/B87

Department of Transport and Main Roads

Road Safety Barrier Systems and End Treatments: Product Information Sheet

This information sheet shall be, where relevant, read in conjunction with the manufacturer's latest manual.

BG800 Steel Gate

Created: Monday, 21 August 2023

8:47 AM

Page 1 of 2

Status*: Accepted

* TMR reserves the right to alter the Status and Status Expiry Date at any time. Always refer to latest version of TMR's Road Safety Barrier Systems and End Treatments document.

Status Commencement Date: Jun 2014

Status Expiry Date*: Not Set

Category: Longitudinal

Gating/Non-Gating: Not Applicable

Sub Category: Semi-Rigid

Redirective/Non-Redirective: Redirective

Main Material: Steel

Permanent/Temporary: Permanent

Ownership:

Highway Care International
<http://www.highwaycareint.com>

Supplier:

Ingal Civil Products
7 Nestor Drive, Meadowbrook QLD 4131
Ph: 3489 9120 Fax: 3489 9130
www.ingalcivil.com.au



Introduction:

BarrierGuard 800 Steel Gate is a hinged steel barrier "gate" intended primarily to provide openings in permanent concrete barrier and to provide construction access in runs of temporary BarrierGuard 800.



Test Level:

NCHRP Report 350 TL-3

Recommended End Treatments:

No end treatment as the gate is embedded into longitudinal barrier system.

Design:

BarrierGuard 800 Steel Gate is a hinged steel gate comprising 6 metre and 12 metre sections of Barrierguard 800 steel barrier with “T-Top” attachments.

The system is 540 mm wide, and 915 mm high.

The maximum length of gate is 30 metres (on the basis of operational manageability). The system is tested on longer lengths.

The system should be installed on smooth level ground. The intended sweep of the gate should be free from kerbs or rapid changes in gradient. Designer should check with supplier for site specific foundation requirements.

Deflection:

Measured (Crash Test) Deflections:

Nominal Mass (kg)	Nominal Angle (deg)	Nominal Speed (km/h)	Recorded Deflection (m)	Note
2,000	25	100	1.162	1

Note:

1 = NCHRP 350 3-21 test ref. BG807. This test comprised a 60 metre length of “free barrier” between anchors. Shorter lengths between ground anchors are likely to result in lower deflections. Designer should consult with supplier for performance of different configurations.

Limitations:

Wheels must be fully retracted when not in use.

Posted speed should be restricted to 40 km/h when gate is open unless exposed barrier ends can be otherwise shielded.

References:

- Australian Standard AS/NZS 3845
- NCHRP Report 350
- TMR Road Planning and Design Manual
- Austroads determination letter dated 14 March 2014
- NSW RMS Acceptance Document dated 14 March 2014
- FHWA letter Ref: HSSD/B-159 dated 8 May 2007
- BarrierGuard 800 Installation Manual – Laura Metaal, Version 2.6
- Austroads acceptance documents dated 06-Mar-2018 (Steel Gate)

