

# Chapter 14

## Roundabouts

# Manual Contents

14

<b>Chapter 1</b> Framework of the Road Planning and Design Manual	<b>Chapter 12</b> Vertical Alignment
<b>Chapter 2</b> Design Philosophy	<b>Chapter 13</b> Intersections at Grade
<b>Chapter 3</b> Road Planning and Design Fundamentals	<b>Chapter 14</b> Roundabouts
<b>Chapter 4</b> Application of Design Principles and Standards	<b>Chapter 15</b> Auxiliary Lanes
<b>Chapter 5</b> Traffic Parameters and Human Factors	<b>Chapter 16</b> Interchanges
<b>Chapter 6</b> Speed Parameters	<b>Chapter 17</b> Lighting
<b>Chapter 7</b> Cross Section	<b>Chapter 18</b> Traffic signals
<b>Chapter 8</b> Safety Barriers and Roadside Furniture	<b>Chapter 19</b> Intelligent Transport Systems
<b>Chapter 9</b> Sight Distance	<b>Chapter 20</b> Roadside Amenities
<b>Chapter 10</b> Alignment Design	<b>Chapter 21</b> Railway and Cane Railway Level Crossings
<b>Chapter 11</b> Horizontal Alignment	<b>Chapter 22</b> Bridges, Retaining Walls and Tunnels

# Table of Contents

<b>Glossary</b>	<b>14-1</b>
<b>14.1 Introduction</b>	<b>14-5</b>
14.1.1 General safety performance of roundabouts	14-5
14.1.2 Traffic capacity of roundabouts	14-6
14.1.3 Linemarking and signing	14-6
14.1.4 Roundabout lighting	14-6
14.1.5 Landscaping	14-6
<b>14.2 Sites for roundabouts</b>	<b>14-8</b>
14.2.1 Appropriate sites for roundabouts	14-8
14.2.2 Inappropriate sites for roundabouts	14-10
14.2.3 Signalisation at roundabouts	14-11
<b>14.3 Number of roundabout legs and angle between legs</b>	<b>14-11</b>
14.3.1 Single lane roundabouts	14-11
14.3.2 Multi-lane roundabouts	14-11
14.3.3 Replacing roundabouts with traffic signals	14-11
14.3.4 Legal requirements of driving on multi-lane roundabouts	14-11
14.3.5 Line-marking of multi-lane roundabouts	14-13
<b>14.4 Number of roundabout lanes</b>	<b>14-19</b>
14.4.1 Number of circulating lanes	14-19
14.4.2 Number of exit lanes	14-19
14.4.3 Left-turn slip lanes	14-19
<b>14.5 Roundabout diameter</b>	<b>14-21</b>
<b>14.6 Roundabout roadway widths</b>	<b>14-22</b>
14.6.1 Design vehicle and vehicle swept paths	14-22
14.6.2 Width of circulating carriageway	14-23
14.6.3 Entry and exit widths	14-24
14.6.4 Over Dimensional (OD) vehicles	14-25
<b>14.7 Curvature and deflection</b>	<b>14-25</b>
14.7.1 Entry curve	14-25
14.7.2 Deflection through roundabouts	14-26

**14**

14.7.3	Exit curves	14-33
<b>14.8</b>	<b>Speed and side friction parameters</b>	<b>14-33</b>
14.8.1	Maximum decrease in speed between successive horizontal elements	14-33
14.8.2	Maximum entry speed	14-36
14.8.3	Potential relative speed of entering and circulating vehicles	14-36
14.8.4	Potential relative speed of exiting and circulating vehicles	14-38
14.8.5	Difference in potential side friction	14-38
<b>14.9</b>	<b>Roundabout software program “ARNDT”</b>	<b>14-38</b>
<b>14.10</b>	<b>Design of reverse approach curves</b>	<b>14-39</b>
<b>14.11</b>	<b>Separation between legs</b>	<b>14-41</b>
<b>14.12</b>	<b>Central and splitter islands</b>	<b>14-41</b>
14.12.1	Central island	14-41
14.12.2	Splitter islands	14-43
<b>14.13</b>	<b>Sight distance</b>	<b>14-44</b>
14.13.1	Criterion 1	14-44
14.13.2	Criterion 2	14-45
14.13.3	Criterion 3	14-47
14.13.4	Other visibility considerations	14-47
<b>14.14</b>	<b>Crossfalls and grades</b>	<b>14-48</b>
14.14.1	Crossfall and grade of circulating carriageway	14-48
14.14.2	Approach grade	14-48
<b>14.15</b>	<b>Clear zone and roadside hazards</b>	<b>14-49</b>
<b>14.16</b>	<b>Pavement conditions</b>	<b>14-49</b>
<b>14.17</b>	<b>Pedestrians</b>	<b>14-49</b>
<b>14.18</b>	<b>Cyclists</b>	<b>14-52</b>
<b>14.19</b>	<b>Special treatments</b>	<b>14-56</b>
14.19.1	Wide medians and streets of unequal width	14-56
14.19.2	Wide undivided streets and “T” intersections	14-56
	<b>References</b>	<b>14-58</b>
	<b>Relationship to other chapters</b>	<b>14-58</b>
	<b>Appendix 14A: Accident types</b>	<b>14-59</b>

<b>Appendix 14B: Vehicle paths and speed prediction model</b>	<b>14-61</b>
<b>Appendix 14C: Procedure to calculate accident rates at roundabouts</b>	<b>14-67</b>

## List of Tables

Table 14.1	Planning guide for the use of roundabouts at intersections of various road types	14-8
Table 14.2	Initial selection of minimum central island diameters of single lane roundabouts	14-22
Table 14.3	Initial selection of minimum central island diameters of two lane roundabouts	14-22
Table 14.4	Initial selection of single lane roundabout circulating carriageway widths	14-23
Table 14.5	Initial selection of two lane roundabout circulating carriageway widths	14-24
Table 14.6	Approach Sight Distance Criteria	14-44
Table 14.7	Criterion 2 sight distances	14-45
Table 14.8	Criterion 2 sight distance for “other” approaches	14-47
Table 14.9	Vehicle path construction methods for the various accident types for multi-lane roundabouts	14-62
Table 14.10	Sideswipe traffic flows	14-84

## List of Figures

Figure 14.1 Geometric elements of a roundabout	14-4
Figure 14.2 Two intersection treatments for roadways that cross at a 90 degree angle	14-7
Figure 14.3 Effect of turning vehicles on roundabout operation	14-10
Figure 14.4 Appropriate lane choice is relatively straight forward at multi-lane roundabouts with legs aligned at 90°	14-12
Figure 14.5 Appropriate lane choice can be difficult to determine on multi-lane roundabouts with some or all legs aligned at angles substantially more or less than 90°	14-14
Figure 14.6 Examples showing potential conflicts arising without the “spiral” line marking system	14-17
Figure 14.7 Examples showing the use of the “spiral” line marking system for the examples shown in Figure 14.6	14-18
Figure 14.8 Configuration of a left turn slip lane with a high entry angle	14-20
Figure 14.9 Configuration of a left turn slip lane with an acceleration lane	14-20
Figure 14.10 Encroachment areas at roundabouts	14-27
Figure 14.11 Desirable and undesirable roundabout approach geometry	14-28
Figure 14.12 Example 1 – design modifications to improve geometry	14-29
Figure 14.13 Example 2 – design modifications to improve geometry	14-30
Figure 14.14 Example 3 – design modifications to improve geometry	14-31
Figure 14.15 Illustration of the deflection criteria for a single lane roundabout	14-32
Figure 14.16 Illustration of the deflection criteria for a multi-lane roundabout	14-32
Figure 14.17 Typical roundabout entrance/exit conditions for urban areas	14-34
Figure 14.18 Examples showing desirable and undesirable separation between roundabout legs	14-35
Figure 14.19 Single lane urban roundabout	14-37
Figure 14.20 Roundabout in a rural environment	14-40
Figure 14.21 Treatment for the central islands of roundabouts	14-42
Figure 14.22 Use of splitter islands to discourage hazardous wrong way movements	14-43
Figure 14.23 Sight distance criteria for roundabouts	14-46

Figure 14.24 The queue length that will be exceeded 95% of the time for pedestrian crossing distances of 5m and 10m	14-51
Figure 14.25 Paths for inexperienced riders at roundabouts	14-54
Figure 14.26 Separate perimeter path details for roundabouts	14-55
Figure 14.27 Roundabout on a road with a very wide median	14-57
Figure 14.28 Roundabout at “T” intersections in an urban area	14-57
Figure 14.29 Geometric elements of a typical roundabout and typical accident types	14-59
Figure 14.30 Accident categories	14-60
Figure 14.31 Vehicle path construction through roundabouts	14-64
Figure 14.32 Construction of a vehicle path on an approach curve	14-64
Figure 14.33 Vehicle path construction for the right lane of multi-lane roundabouts – through movement depicted	14-65
Figure 14.34 85 <sup>th</sup> percentile passenger car speed versus horizontal curve radius	14-66
Figure 14.35 Example calculation of 85 <sup>th</sup> percentile speeds of passenger cars	14-66
Figure 14.36 Roundabout example for the calculation of accident rates according to the procedures given in this appendix	14-69
Figure 14.37 Codes for vehicle path segments	14-70
Figure 14.38 Calculation of single vehicle accident rates for vehicles travelling from the Southern leg for the roundabout in shown Figure 14.36	14-71
Figure 14.39 The various traffic flows on the circulating carriageway and the various relative speeds between entering and circulating vehicles	14-73
Figure 14.40 Calculation of approaching rear-end vehicle accident rates on the Southern leg for the roundabout shown in Figure 14.36	14-74
Figure 14.41 The various travel times taken from the holding line of the particular preceding approach to the intersection point between entering and circulating vehicles	14-78
Figure 14.42 Calculation of entering/circulating vehicle accident rates on the Southern leg for the roundabout shown in Figure 14.36	14-79
Figure 14.43 The various circulating and exiting traffic flows and various relative speeds between exiting and circulating vehicles	14-80
Figure 14.44 Calculation of exiting/circulating vehicle accident rates on the Southern leg for the roundabout shown in Figure 14.36	14-82
Figure 14.45 Example for the use of calculating traffic flows for the sideswipe vehicle accidents	14-86



Figure 14.46 Calculation of sideswipe vehicle accident rates for vehicles travelling from the Southern leg for the roundabout shown in Figure 14.36 14-87

# Chapter 14 Amendments – January 2006

## Revision Register

14

Issue/ Rev No.	Reference Section	Description of Revision	Authorised by	Date
1	-	First Issue	Steering Committee	May 2000
2	14.13.1	Modifications to the last paragraph.	Steering Committee	Sept 2000
	14.13.2	Modifications to the second paragraph.		
	14.13.3	Modifications to the first paragraph.		
	14B.1	Modifications to the first paragraph.		
	14B.2	Modifications to title of Figure 14B.1.		
	14B.3	Modifications to title of Figure 14B.2.		
3	14B.5	Addition of new section and Figure 14B.5.	Steering Committee	May 2001
	14.1.1	New section "Terminology" and new Figure 14.1.		
	14.8.1	Addition of alternative treatments to slow vehicles.		
4	All	Redefinition of particular terms throughout the Chapter. e.g. 'Approach Curve' to 'Entry Curve', Departure Curve' to 'Exit Curve', 'Curve Prior to the Approach' to 'Approach Curve' and other minor modifications.	Steering Committee	Sept 2001
	14.1.2	Pedestrians and Cyclists -Three additional paragraphs referring to needs of pedestrians and cyclists.		
	14.2.1	Traffic predictions - New paragraph warning about changes in future traffic making a site unsuitable.		
	14.2.3	New section - New statement about the signalisation of roundabouts		
	14.3.4	New Regulations - Changes to reflect replacement of Regulation 1962 with the Transport Operations (Road Use Management Road Rules) Regulation 1999.		
	14.5	Speed reduction treatment - Tables 14.2 & 14.3 modified.		
14.5	Maximum diameter - Max. diameter of 200m defined.			

Issue/ Rev No.	Reference Section	Description of Revision	Authorised by	Date
4	14.10	Design of Reverse Approach Curves - Inclusion of additional issues.	Steering Committee	Sept 2001
	14.11	Correction to last sentence.		
	14.18	Cyclists - Extra dot point regarding daily traffic volumes; Reference to Austroads GTEP Part 14 - Bicycles.		
	New	'References' and 'Relationship to Other Chapters' added.		
5	14.1.1	Terminology - "Sight" not "site"; new definition - "Rumble Strips"; change to definition of "Safety Bars"; editing corrections; Figure 14.1 corrections.	Steering Committee	Feb 2002
	14.1.2	5th paragraph - Add "Well designed" at the start; 7th paragraph - additional sentence re exits being hazardous.		
	14.2.1	Table 14.1 expanded to give complete picture and match Austroads publication.		
	14.2.2	2nd dot point corrected.		
	14.3.1	Single lane roundabouts - Additional comment regarding three leg roundabouts.		
	14.5	Tables 14.2 and 14.3 - Diameter changed to Radius.		
	14.6	Encroachment areas - Figure 14.9 modified		
	14.7.1	2nd sentence changed; Figure 14.10 modified		
	14.8	Minor changes to paragraphs in 4.8.1.		
	14.15	Lighting: Additional sentence at end of section - central lighting.		
	14.17	Pedestrians - Additional sentence re exits in 1st paragraph.		
	Example 14B	Figure - Note added; marking corrected		
	Appendices	Figures 14B-3, 14C-8 and 14C-10 modified to show correct marking.		
6	14.5	Tables 14.2 and 14.3 modified.	Steering Committee	June 2002
	14.6.2	Tables 14.4 and 14.5 modified.		
	14.9	Second paragraph modified.		
	14.10	Modifications.		

14

Issue/ Rev No.	Reference Section	Description of Revision	Authorised by	Date
7	All	All figures and tables renumbered. References in text amended to reflect the renumbering.	Steering Committee	August 2005
	Section 14.1.1	Section 14.1.1 replaced with Glossary. Definitions included for ARNDT, circulating carriageway width, eighty-fifth percentile speed, departure width, entry width, exit width, speed environment and sight distance. "Give way line" changed to "Holding line". Definition for "Entering Sight Distance" deleted. Definition for "Stopping Sight Distance" amended.		
	Section 14.1.2/ 14.1.1	Section 14.1.2 renumbered to 14.1.1.		
	Section 14.1.3/ 14.1.2	Section 14.1.3 renumbered to 14.1.2. Section retitled "Traffic capacity of roundabouts".		
	Section 14.1.3/ 14.1.2	Section 14.1.3 renumbered to 14.1.2. Section retitled "Traffic capacity of roundabouts".		
	Sections 14.1.4 to 14.1.6/ 14.1.3 to 14.1.5	Sections 14.1.4, 14.1.5 and 14.1.6 renumbered to 14.1.3, 14.1.4 and 14.1.5 respectively.		
	Section 14.2 and Table 14.1.	Dot points in Section 14.2 amended. Table 14.1 amended.		
	Section 14.3.3	New section titled "Replacing roundabouts with traffic signals" included. New section stating future signalisation of roundabouts should be considered.		
	Section 14.3.3/ 14.3.4	Section 14.3.3 renumbered to 14.3.45.		

Issue/ Rev No.	Reference Section	Description of Revision	Authorised by	Date
7	Section 14.3.4/ 14.3.5 and Figures 14.05 to 14.07	Section 14.3.4 rewritten and renumbered to 14.3.5. Old Figures 14.05 and 14.06 amended. New figure, Figure 14.07, added. New and amended figures created to emphasise problems with multi-lane roundabouts with more than four legs and/or with legs aligned such that angles between legs are significantly more or less than 90°.	Steering Committee	August 2005
	Section 14.7.1, Figure 14.10 and Figures 14.12 to 14.14	Two sentences added to end of section. Figure 14.09 amended and re-numbered to Figure 14.10. Additional examples (Figures 14.12 to 14.14) added to illustrate poor geometry at roundabouts and how the geometry can be improved to increase safety.		
	Section 14.8	First two paragraphs amended.		
	Section 14.8.1	Some text added/amended.		
	Example 14A, Section 14.8.3 and Figure 14.19	Text and figure for Old Example 14A moved forward from Example 14A into Section 14.8.3.		
	Example 14B, Section 14.10 and Figure 14.20	Text and figure for old Example 14B moved forward from Example 14B into Section 14.10.		
	Section 14.12.2	Paragraph regarding sight distance added to end of section.		
	Section 14.13	Paragraph/dot points regarding application of criterion added.		
	Section 14.13.3	Last paragraph moved to Section 14.13.		
	Section 14.16	Paragraph added regarding choice of surface wearing course for pavement.		

**14**

Issue/ Rev No.	Reference Section	Description of Revision	Authorised by	Date
7	Section 14.17	Sentence added at the start of the section. Sentence added regarding signalised intersections.	Steering Committee	August 2005
8	Sections 14.8.1 and 14.17	Cross references corrected.	Principal Engineer (Road Engineering Standards)	Jan 2006
	Appendix 14C	Equations 14-1, 14-2, 14-3, 14-7, 14-9, 14-11 and 14-12 corrected.		

# Chapter 14

## Roundabouts

14

### Glossary

Special terminology used in this chapter is given below. Some of the terms are detailed in Figure 14.1.

**Approach carriageway:** A carriageway on which vehicles approach the roundabout. This includes the entry curve and any approach curves.

**Approach curve:** A horizontal curve used on the approach to the roundabout, upstream of the entry curve (refer Figure 14.1).

**Approach Sight Distance (ASD):** Stopping sight distance measured from driver eye height to the surface of the road on the approach to an intersection or roundabout.

**Approach speed:** The representative speed (usually taken as the operating speed) of traffic approaching a site.

**Approach width:** The width of the approach carriageway prior to any approach curves (refer Figure 14.1).

**ARNDT:** A computer program that identifies the likely safety performance of a new or existing roundabout. It is based on the results of the roundabout study (Arndt, 1998).

**Carriageway:** That portion of the road devoted particularly to the use of vehicles, inclusive of shoulders and auxiliary lanes.

**Central island:** The circular or other specially shaped central island constructed or marked at the intersection and around which traffic circulates in a clockwise direction.

**Central island radius/diameter:** The radius/diameter of the circle that forms the kerb line of the central island (refer Figure 14.1). The central island may not necessarily be a single radius/diameter curve; compound circular curves may be used where necessary.

**Circulating carriageway:** The carriageway around the central island on which circulating vehicles travel in a clockwise direction (refer Figure 14.1).

**Circulating carriageway width:** The width of the circulating carriageway (refer Figure 14.1).

**Collector-distributor road:** A road, the prime function of which is to collect traffic from local roads and distribute it to arterial roads.

**Corner cut-off (splay):** The truncation of property boundaries adjacent to an intersection/roundabout.

**Corner kerb radius (kerb return):** The radius of the corner kerb between adjacent entry and exit curves (refer Figure 14.1).

**Crossfall (camber):** The cross slope of the road surface at right angles to the road alignment, usually expressed as a percentage.

**Departure carriageway:** A carriageway on which vehicles depart the roundabout. This includes the exit curve/s.

**Departure width:** The width of the departure carriageway after the exit curve (refer Figure 14.1).

**Design vehicle:** A hypothetical vehicle whose dimensions and operating characteristics are used to establish certain aspects of road and intersection layout and geometry.

**Eighty-fifth (85<sup>th</sup>) percentile speed:** Eighty-fifth (85<sup>th</sup>) percentile speed is the speed at, or below, which 85 percent of cars are observed to travel under free flowing conditions past a nominated point. Eighty-five percent of the cars will have a speed equal to or slower than this speed, and 15 percent of cars will have a speed equal to or greater than this speed (considering only those vehicles not constrained by other vehicles, i.e. vehicles experiencing free flowing conditions). A vehicle is considered to be operating under free flowing conditions when the preceding vehicle has at least six seconds headway and there is no apparent attempt to overtake the vehicle ahead. For roundabouts the 85<sup>th</sup> percentile speed on each element should be determined using the procedure presented in Appendix 14B of this Chapter. The speed environment of the road section to which the roundabout belongs must be determined before the 85<sup>th</sup> percentile speeds on roundabout elements can be calculated.

**Entry curve:** The horizontal curve of the approach carriageway which leads vehicles into the circulating carriageway (refer Figure 14.1).

**Entry width:** The width of the approach carriageway measured at the entry to the circulating carriageway (refer Figure 14.1).

**Exit curve:** The horizontal curve of the departure carriageway which leads vehicles out of the circulating carriageway (refer Figure 14.1).

**Exit width:** The width of the departure carriageway measured at the exit from the circulating carriageway (refer Figure 14.1).

**Holding line:** A broken line used to indicate the safe position for a vehicle to be held at a give way sign. At roundabouts, it is usually positioned where the approach carriageway meets the circulating carriageway. Markings should not normally be placed across the exits from a roundabout (refer Figure 14.1 and the Manual of Uniform Traffic Control Devices [MUTCD]).

**Kerb blister:** A bulge introduced in an existing kerb line to narrow the approach or departure carriageway adjoining roundabout. It is generally used to limit the maximum radius (and hence speed) that can be used by a vehicle when negotiating a roundabout.

**Leg:** A leg may comprise both approach and departure carriageways or an approach or departure carriageway alone.

**Multi-lane roundabout:** A roundabout with any one or more of the following elements designed for, or operated as, two or more lanes or streams of traffic:

- one or more approach carriageways;
- one or more departure carriageways; and/or
- part or all of the circulating carriageways.

**Roundabout:** A roundabout is a channelised at grade intersection at which all traffic moves clockwise around a central traffic island.



**Rumble strips:** Narrow transverse raised or specially textured strips placed on a pavement or sealed shoulder, generating noise and vibrations through vehicles in order to alert drivers to a changed situation and so encourage them to slow down.

**Safety bars (Jiggle bars):** Parallel raised transverse bars placed on a pavement or sealed shoulder to discourage drivers from using that portion of the carriageway.

**Safe Intersection Sight Distance (SISD):** The sight distance required at an intersection/a roundabout for a driver on the major road to observe a vehicle from a minor road moving into a collision situation, and to decelerate to a stop before reaching the collision point

**Sight triangle:** The area of land between two intersecting roadways over which vehicles on either roadway are, or need to be, mutually visible

**Single-lane roundabout:** A roundabout with all carriageways designed for and/or operated as a single lane or stream of traffic.

**Speed environment:** Speed environment is a measure of the influence that various factors have on the desired speed of drivers on significant lengths of road. It is numerically equal to the desired speed of the 85<sup>th</sup> percentile driver over a section of road. The speed environment of the road section to which the roundabout belongs must be determined before the 85<sup>th</sup> percentile speeds on roundabout elements can be calculated. For a detailed discussion refer to Chapter 6 of this manual.

**Sight distance:** The distance, measured along a carriageway, over which visibility occurs between a driver and an object (single vehicle sight distance) or between two drivers at specific heights above the carriageway in their lane of travel.

**Splitter island:** The island placed within a leg of the roundabout to separate the entering and exiting traffic, and designed to deflect entering traffic (refer Figure 14.1).

**Stopping sight distance:** The sight distance that allows a driver to perceive and react to a hazard, and completely stop prior to the hazard. Refer to Section 14.13 for roundabouts (and other relevant chapters [e.g. 9, 10, 11, 12, 13, 15, 16 and 21] for more information).

14

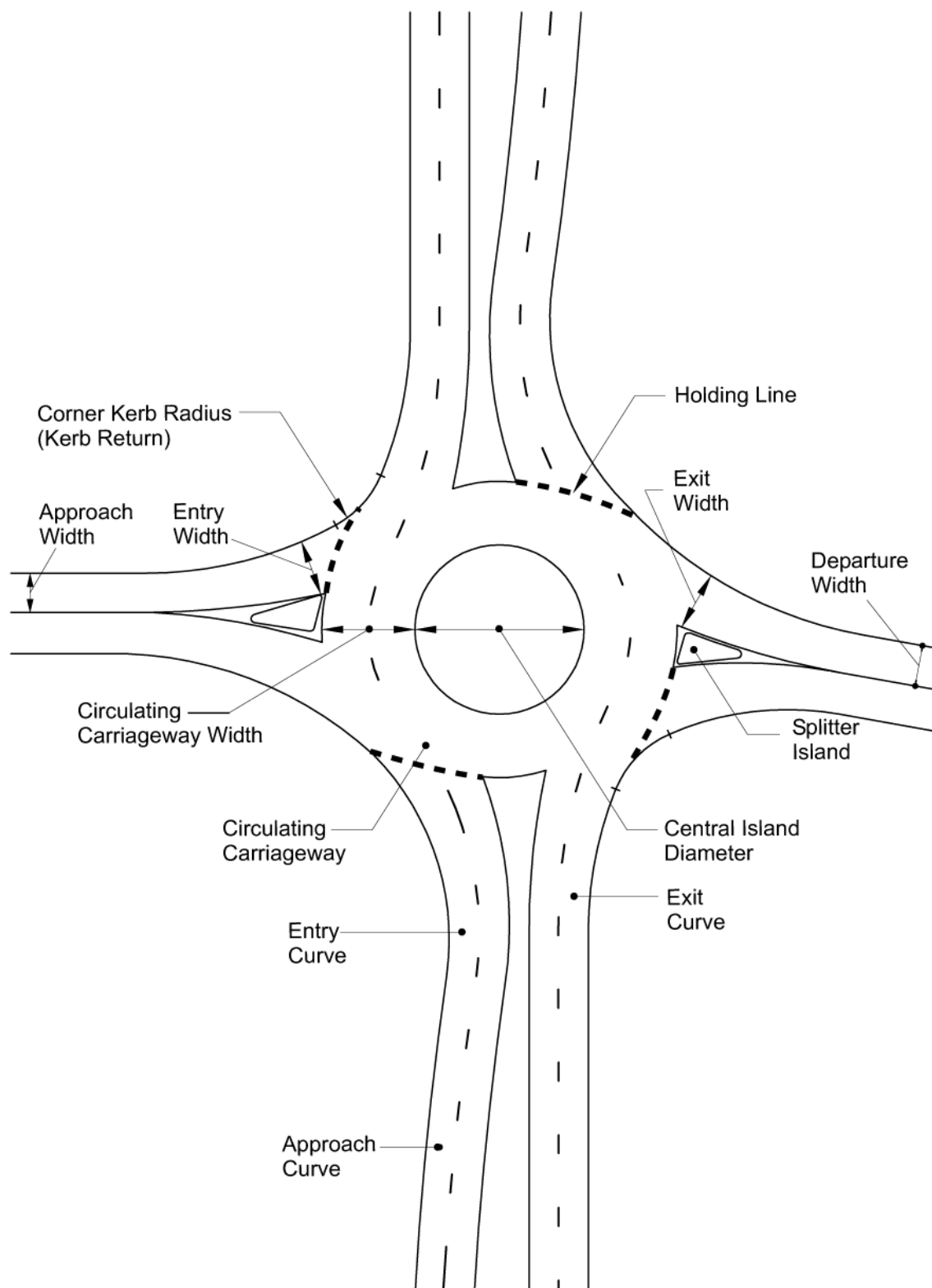

Figure 14.1 Geometric elements of a roundabout

## 14.1 Introduction

This section discusses guidelines for the design of roundabouts. These guidelines are based on the Guide to Traffic Engineering Practice (GTEP) - Part 6 - Roundabouts (Austroads, 1993), and the results of a roundabout study undertaken by Main Roads (Arndt, 1998). These guidelines refer to five major accident types identified in the roundabout study (refer to Arndt, 1998, and Appendix 14A).

A computer program has been developed based on the results of the roundabout study and is titled A Roundabout Numerical Design Tool (ARNDT). It identifies the likely safety performance of a new or existing roundabout. The use of this program is discussed in Section 14.9.

The guidelines presented in this chapter detail how a number of geometric parameters at roundabouts can be designed so that accident rates are minimised. Often, the effect of one geometric parameter on accident rates cannot be considered in isolation because it can affect a number of other parameters. For example, increasing the number of legs for a given roundabout diameter will usually change the approach carriageway geometry because less room is available to obtain adequate approach curvature. This interrelationship needs to be considered when choosing appropriate values of the various geometric parameters.

### 14.1.1 General safety performance of roundabouts

In general, a well designed roundabout is the safest type of intersection control. 'Before and after' type studies have shown that in general, fewer vehicle accidents occur at roundabouts than at intersections

containing traffic signals, stop or give way signs. The primary reason for this is that the potential relative speeds of vehicles are considerably lower for a well designed roundabout than for other types of at-grade intersections.

Figure 14.2 shows two intersection treatments for roadways that cross at a 90 degree angle. The desired speed on each of the cross roads is 60km/h. The upper diagram in Figure 14.2 shows a typical at-grade intersection treatment. The potential relative speed of vehicles on adjacent roadways at this intersection is 85km/h.

The lower diagram in Figure 14.2 shows a roundabout at the intersection of these cross roads. The potential relative speed of entering and circulating vehicles at this roundabout is 46km/h. This value is much lower than the 85km/h for the at-grade intersection.

Higher potential relative speeds of vehicles result in higher multiple vehicle accident rates and greater accident severity. The at-grade intersection will generally record significantly higher multiple vehicle accident rates than the roundabout.

Well designed roundabouts achieve a lower potential relative speed of vehicles on the cross roads primarily because of the presence of entry curvature. Entry curvature limits the speed at which drivers can enter the circulating carriageway.

Conversely, a poorly designed roundabout with little entry curvature or deflection results in high speeds through the roundabout creating high potential relative speeds between vehicles. Multiple vehicle accident rates at these roundabouts can actually be higher than for an equivalent at-grade intersection. Therefore it is important

that designers give special attention to the design of the geometry of roundabouts.

Special consideration must be given to pedestrian movement/s at roundabouts. While not necessarily less safe than other intersection types, children and elderly pedestrians feel less safe at roundabouts, particularly at exits. This is because, unlike traffic signals, roundabouts do not give priority to pedestrians over through traffic. Several treatments to overcome these problems are suggested in Section 14.17.

It is also important to note that several studies have shown that roundabouts increase the risk of accidents to cyclists. Roundabouts designed with good entry curvature (as discussed above) minimise cyclist accidents. Special treatments for cyclists are presented in Section 14.18.

**Note that at locations where there are high levels of cycle and pedestrian traffic, roundabouts may not be the most appropriate intersection treatment and alternative treatments should be considered.**

For roundabouts to perform effectively they must be easily identified in the road system, the layout must be apparent to approaching drivers and the approaches must encourage drivers to enter the intersection slowly. Adequate sight distance should be provided to enable drivers to observe the movements of other vehicles, cyclists, and pedestrians.

Roundabouts operate as a series of separate T-intersections. The approaching drivers are required to give way to the circulating vehicles on the roundabout and to look for an acceptable gap in the circulating traffic so that they can enter in a safe manner. The behaviour of the driver is related to the geometry of the roundabout and prevailing traffic conditions.

### 14.1.2 Traffic capacity of roundabouts

The performance of roundabouts, techniques for capacity analysis of roundabouts including software packages, and worked examples are covered in the GTEP - Part 6 - Roundabouts (Austroads, 1993).

### 14.1.3 Linemarking and signing

Linemarking and signing of roundabouts is to be in accordance with the Manual of Uniform Traffic Control Devices (MUTCD, Queensland Department of Main Roads [QDMR], 2003). In addition, linemarking of multi-lane roundabouts is to be in accordance with the Guide to Pavement Marking (QDMR, 2001).

### 14.1.4 Roundabout lighting

Warrants and guidelines for lighting on roundabouts are given in Chapter 17 of this manual.

### 14.1.5 Landscaping

Landscaping of roundabouts is to be in accordance with the Road Landscape Manual (QDMR, 2004) and Sections 14.12, 14.13 and 14.15 of this Chapter.

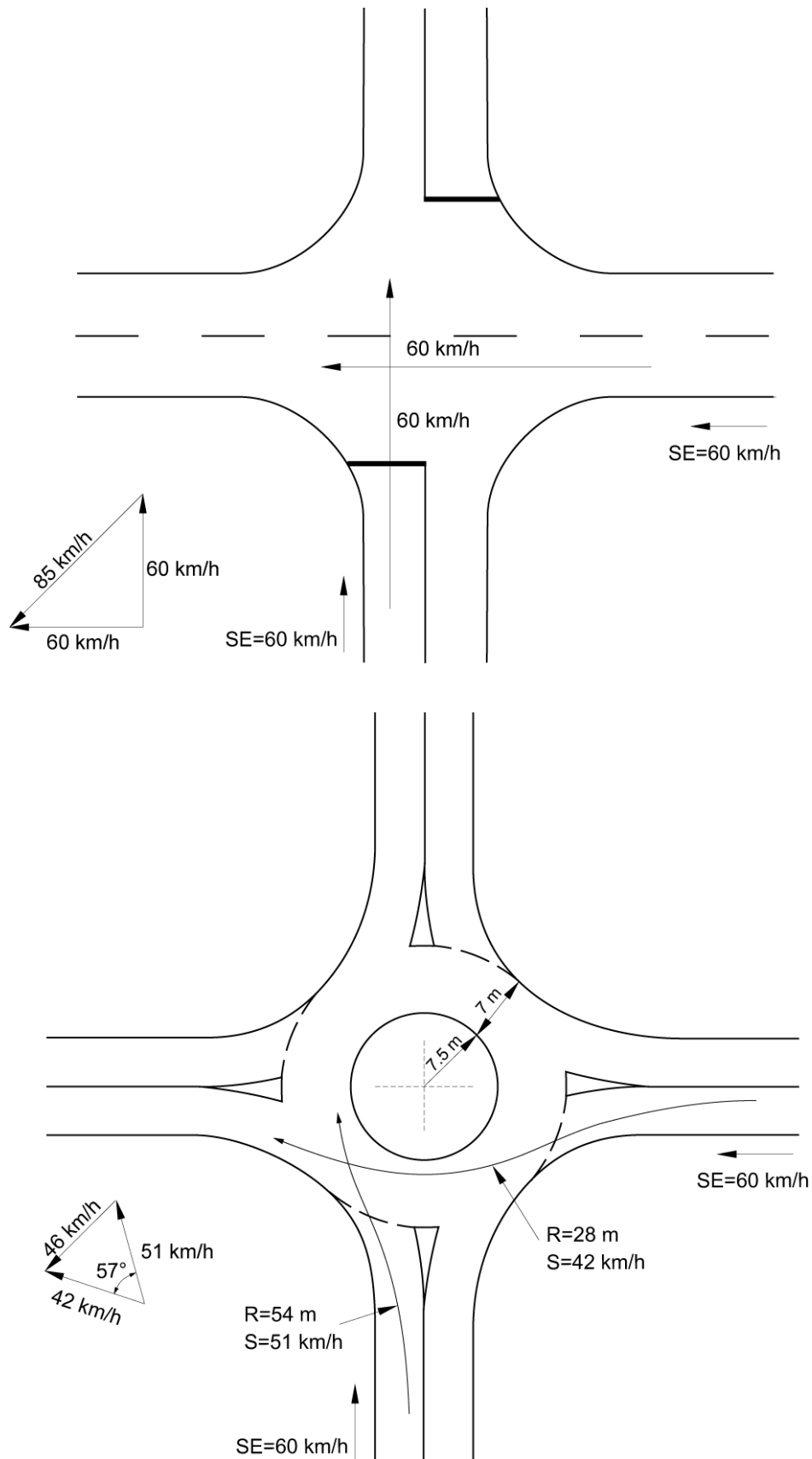

Figure 14.2 Two intersection treatments for roadways that cross at a 90 degree angle

## 14.2 Sites for roundabouts

Roundabouts can be used satisfactorily at a wide range of sites, such as:

- intersections on arterial roads in urban areas;
- intersections on rural roads; and
- intersections at motorway terminals (and at terminals of roads performing a motorway function - refer to Chapter 16 of this Manual).

Roundabouts perform better at the intersection of roads with roughly similar traffic flows and a high proportion of right turning traffic. Roundabouts can improve safety by simplifying conflicts, reducing vehicle speeds and providing a clearer indication of the driver's right of way compared to other forms of channelisation.

### 14.2.1 Appropriate sites for roundabouts

Since so many factors need to be considered, it is not possible to specify whether roundabouts should or should not be installed in various general situations. However, Table 14.1 may be used as a guide to the general applicability of a roundabout treatment to the intersection of various functional road classifications. Table 14.1 should not be used as the only assessment as it is more appropriate to consider each case on its merits, evaluating the advantages and disadvantages of alternative treatments.

**Table 14.1 Planning guide for the use of roundabouts at intersections of various road types**

	Arterial Rd/ Rural Hwy	Sub-Arterial Rd/Rural Rd	Collector Rd	Local St
Motorway	D	E	E	E
Arterial Rd/ Rural Hwy	B	B	C	C
Sub-Arterial Rd/ Rural Rd	-	B	B	C
Collector Rd	-	-	A	B
Local St	-	-	-	A
Notation: A. Likely to be an appropriate treatment B. May be an appropriate treatment C. Not likely to be an appropriate treatment D. Not appropriate on motorway itself. May be appropriate as part of an interchange (e.g. at the intersection of ramps and the minor road). Refer to Chapter 16 of this manual. E. Not likely to have an interchange (or roundabout) between a motorway and this road type.				

Roundabouts may be appropriate in the following situations:

- At intersections where traffic volumes on the intersecting roads are such that:
  - “Stop” or “Give Way” signs or the “T” junction rule result in unacceptable delays for the minor road traffic. In these situations, roundabouts would decrease delays to minor road traffic, but increase delays to the major road traffic.
  - Traffic signals would result in greater delays than a roundabout. It should be noted that in many situations roundabouts provide a similar capacity to signals, but may operate with lower delays and better safety, particularly in off-peak periods.

- At intersections where there are high proportions of right-turning traffic:
  - o Unlike most other intersection treatments, roundabouts can operate efficiently with high volumes of right-turning vehicles. Indeed, these right-turning vehicles contribute to good roundabout operation as is illustrated in Figure 14.3. In this example the right turner from Leg A to Leg D would stop the through movement from Leg C to leg A thus allowing traffic from Leg D to enter the roundabout. Traffic from Leg D would then stop the through movement from Leg A thus allowing traffic from Leg B to enter the roundabout. Right turners from Leg A in this example would initiate traffic flow on adjacent entries and Leg D which would otherwise experience longer delay.
- At rural cross intersections (including those in areas with high desired speeds) at which there is an accident problem involving crossing or right turn (versus opposing) traffic. However if the traffic flow on the lower volume road is less than about 200 vehicles per day, consideration could be given to using a staggered “T” treatment.
- At intersections of arterial roads in outer urban areas where traffic speeds are high and right turning traffic flows are high. A well designed roundabout could have an advantage over traffic signals in reducing right turn opposed type accidents and overall delays.
- At “T” or cross intersections where the major traffic route turns through a right angle. This often occurs on highways in country towns. In these situations the major movements within the intersection are turning movements.
- Where major roads intersect at “Y” or “T” junctions, where a high proportion of right turning traffic exists.
- At locations where traffic growth is expected to be high and where future traffic patterns are uncertain or changeable.
- At intersections of local roads where it is desirable not to give priority to either road.
- At intersections with more than four legs, if one or more legs cannot be closed or relocated or some turns prohibited, roundabouts may provide a convenient and effective treatment whereas:
  - o With “Stop” or “Give Way” signs, it is often not practical to define priorities adequately;
  - o Signals may be less efficient due to the large number of phases required (resulting in a high proportion of lost time).

Two lane roundabouts with more than four legs, however, often cause operational problems as discussed in Section 14.3.2 and generally should be avoided.

**Care should be taken in assessing the future traffic volumes and their patterns. It is possible that a site considered appropriate for a roundabout now, may become inappropriate in the future, requiring extensive modification to the intersection. Designers should consider the potential to build in flexibility in the design to accommodate possible future changes, particularly when land use changes alter traffic patterns considerably.**

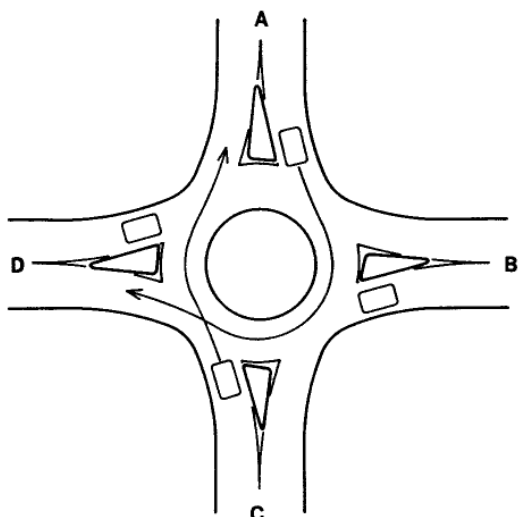

**Figure 14.3 Effect of turning vehicles on roundabout operation**

### 14.2.2 Inappropriate sites for roundabouts

Roundabouts may be inappropriate in the following situations:

- Where a satisfactory geometric design cannot be provided due to insufficient space or unfavourable topography, or there is an unacceptably high cost of construction (which includes the cost of property acquisition, service relocations, etc).
- Where traffic flows are unbalanced with high volumes on one or more approaches, and some vehicles would experience long delays. This is especially true for roundabouts on high desired speed, high volume rural roads which intersect with a very low volume road. In these cases, the number of single vehicle accidents generated by the roundabout can substantially exceed the number of multiple vehicle accidents generated by an at-grade intersection.
- Where a major road intersects a minor road and a roundabout would result in

unacceptable delay to the major road traffic. A roundabout causes delay and deflection to all traffic, whereas control by STOP or GIVE-WAY signs or the 'T' junction rule would result in delays to only the minor road traffic.

- Where there is considerable pedestrian activity and due to high traffic volumes it would be difficult for pedestrians to cross any leg.
- At an isolated intersection in a network of linked traffic signals. In this situation a signalised intersection linked to the others or simply an at-grade intersection would generally provide a better level of service.
- At an isolated intersection where the treatment is inconsistent with the network/link and the expectations of the driver (i.e. design consistency is not maintained, refer to Chapter 2 of this manual).
- Where peak period reversible (i.e. tidal flow) lanes may be required.
- Where large multi-combination or over-dimensional vehicles frequently use the intersection and insufficient space is available to provide for their swept turning paths.
- Where traffic flows leaving the roundabout would be interrupted by downstream traffic control which could result in queuing back into the roundabout. An example of this is a nearby signalised pedestrian crossing. The use of roundabouts at these sites need not be completely discounted, but they are generally found to be less effective than adopting a signalised intersection treatment.



### 14.2.3 Signalisation at roundabouts

Changes in traffic demand and patterns of movement at an existing roundabout may produce excessive delays and queuing on one or more legs. One solution may be to provide traffic signal control of one or more movements to provide a satisfactory level of service. In some cases, signals may not be required at all times and flexibility of operation must be provided. Appropriate warning signs will be required. (Refer also to Chapter 18 of this Manual.)

## 14.3 Number of roundabout legs and angle between legs

### 14.3.1 Single lane roundabouts

Aligning roundabout legs at approximately 90° is preferable because it results in the least amount of driver confusion. This design limits the maximum number of roundabout legs to four. However, the provision of a greater number of legs on a single lane roundabout is allowable if economic constraints dictate. It is suggested, however, that more than six legs would lead to driver confusion as to which exit leg is required. Adequate signing would also be difficult to obtain.

### 14.3.2 Multi-lane roundabouts

Multi-lane roundabouts should be limited to a maximum of four legs with legs aligned at approximately 90°. Three and four leg multi-lane lane roundabouts allow legs to be formed at approximately 90°, which helps motorists determine the appropriate lane choice for their path through the roundabout.

Multi-lane roundabouts with more than four legs have some or all legs aligned at angles other than 90°. On these roundabouts, motorists can experience difficulty in determining which is the appropriate lane choice required for left, through and right turns on some of the approaches, as discussed in the following sections.

### 14.3.3 Replacing roundabouts with traffic signals

Designers and planners should consider the potential (future) need for upgrading a roundabout to a signalised intersection and take this into account into their planning and design activities.

Changing a roundabout to a signalised intersection will be easier to achieve, and likely result in a better signalised intersection layout, if the roundabout concerned:

- has roundabout with legs aligned at approximately 90°; and
- has no more than four legs.

This is particularly the case for multi-lane roundabouts.

### 14.3.4 Legal requirements of driving on multi-lane roundabouts

#### Drivers

The Transport Operations (Road Use Management - Road Rules) Regulation (Office of Queensland Parliamentary Counsel [OQPC], 1999) requires drivers to choose the appropriate lane for travel through the roundabout. This choice must be made based on the following requirements:

14

- If the driver intends to leave the roundabout less than half way around it, the left lane only must be used.
- If the driver intends to leave the roundabout more than half way around it, the right lane only must be used.
- If the driver intends to leave the roundabout halfway around it, either lane may be used.
- If a marked lane has traffic lane arrows indicating a different course, the driver must follow the course indicated.

On roundabouts with legs at approximately 90°, determination of the appropriate lane choice in accordance with the above requirements above is relatively straightforward (refer Figure 14.4).

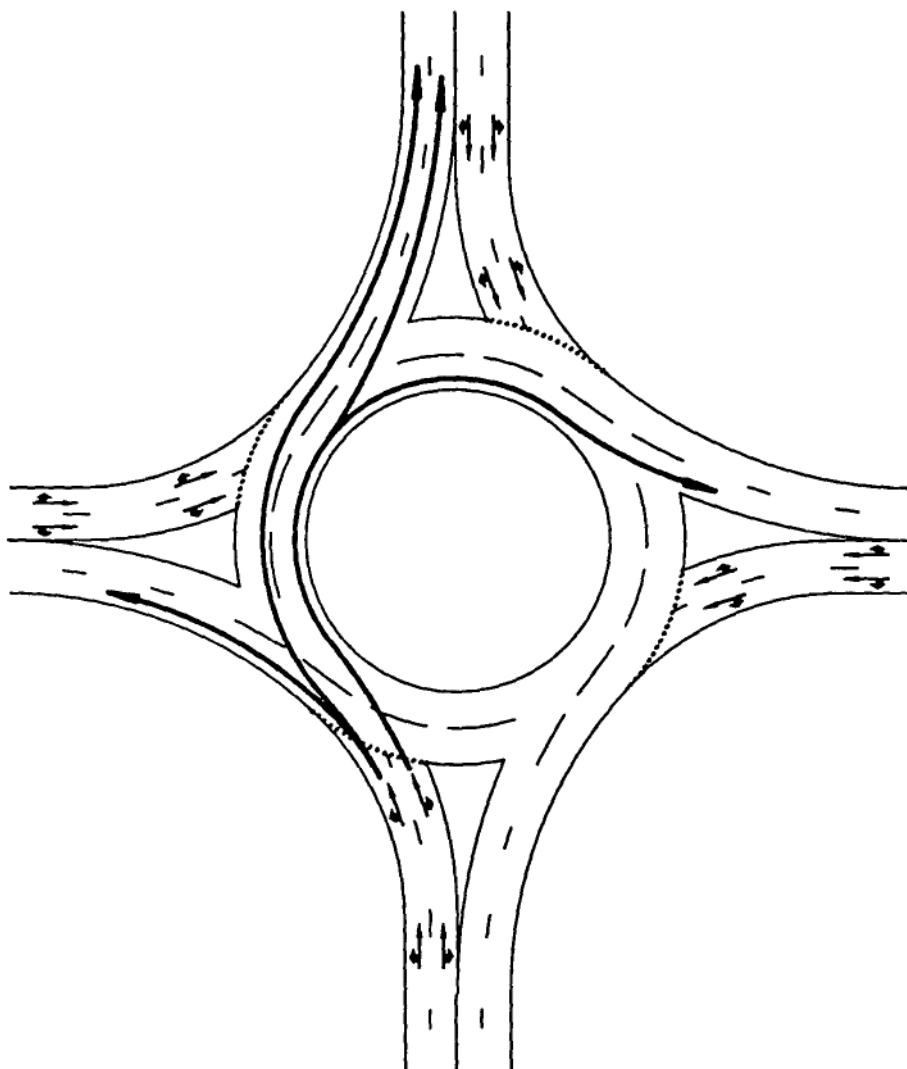

Figure 14.4 Appropriate lane choice is relatively straight forward at multi-lane roundabouts with legs aligned at 90°

On roundabouts with legs forming angles substantially different to 90°, it can be very difficult for drivers to choose the appropriate lane in accordance with the above requirements of the Traffic Regulation unless special advance warning signs are installed. This includes roundabouts that are delineated in accordance with Guide to Pavement Markings (QDMR, 2001). This geometry can also make it very difficult or impossible for police to determine who is at fault in an exiting/circulating vehicle accident. Layouts of such roundabouts are shown in Figure 14.5. This issue is discussed further in Section 14.3.5.

### Cyclists

Section 119 of the Transport Operations (Road Use Management - Road Rules) Regulation (OQPC, 1999) states that cyclists may make a right hand turn from either the left or the right hand lane of a multilane roundabout provided they give way to exiting traffic.

### 14.3.5 Line-marking of multi-lane roundabouts

The line marking system for multi-lane roundabouts outlined in the Guide to Pavement Markings (QDMR, 2001) places pavement arrows on the approach legs to direct motorists into the correct lane for the particular manoeuvre they need to make. In addition, exit lines are marked to ensure that the motorist who enters the correct lane can exit without having to change lanes within the roundabout. Examples of this line marking treatment are shown in Figure 14.4.

On multi-lane roundabouts with more than four legs and/or with legs aligned at

significantly less or more than 90°, it can be difficult for drivers to determine to which legs the pavement arrows are pointing. Part of the difficulty is caused by:

- the pavement arrows pointing to directions one less than the available exit legs (e.g. Leg 1 in Example A and Legs 1 and 3 in Example B, both shown in Figure 14.5);
- the pavement arrows pointing in different directions along the length of the entry curve, particularly if a long entry curve is used, and/or
- the potential conflict between the pavement arrows and the exit line marking guiding the driver out of the circulating carriageway (e.g. in Examples A and B of Figure 14.5 there is potential confusion as to whether the Leg 1 “straight ahead” pavement arrow refers to the movement to Leg 3 or Leg 4).

Because of this difficulty, the approach pavement arrows may not be effective in reducing exiting/circulating vehicle accidents on multi-lane roundabouts with more than four legs, and/or with legs aligned at significantly less or more than 90°. Such geometry is undesirable for new roundabouts and should only be considered when alternative treatments are unavailable or impracticable. Alternative treatments include forming cul-de-sacs on particular legs or creating two separate intersections. If non-standard geometry is adopted, it is recommended that advance intersection direction signs be used in accordance with the Traffic and Road Use Management Manual (QDMR, 2004).

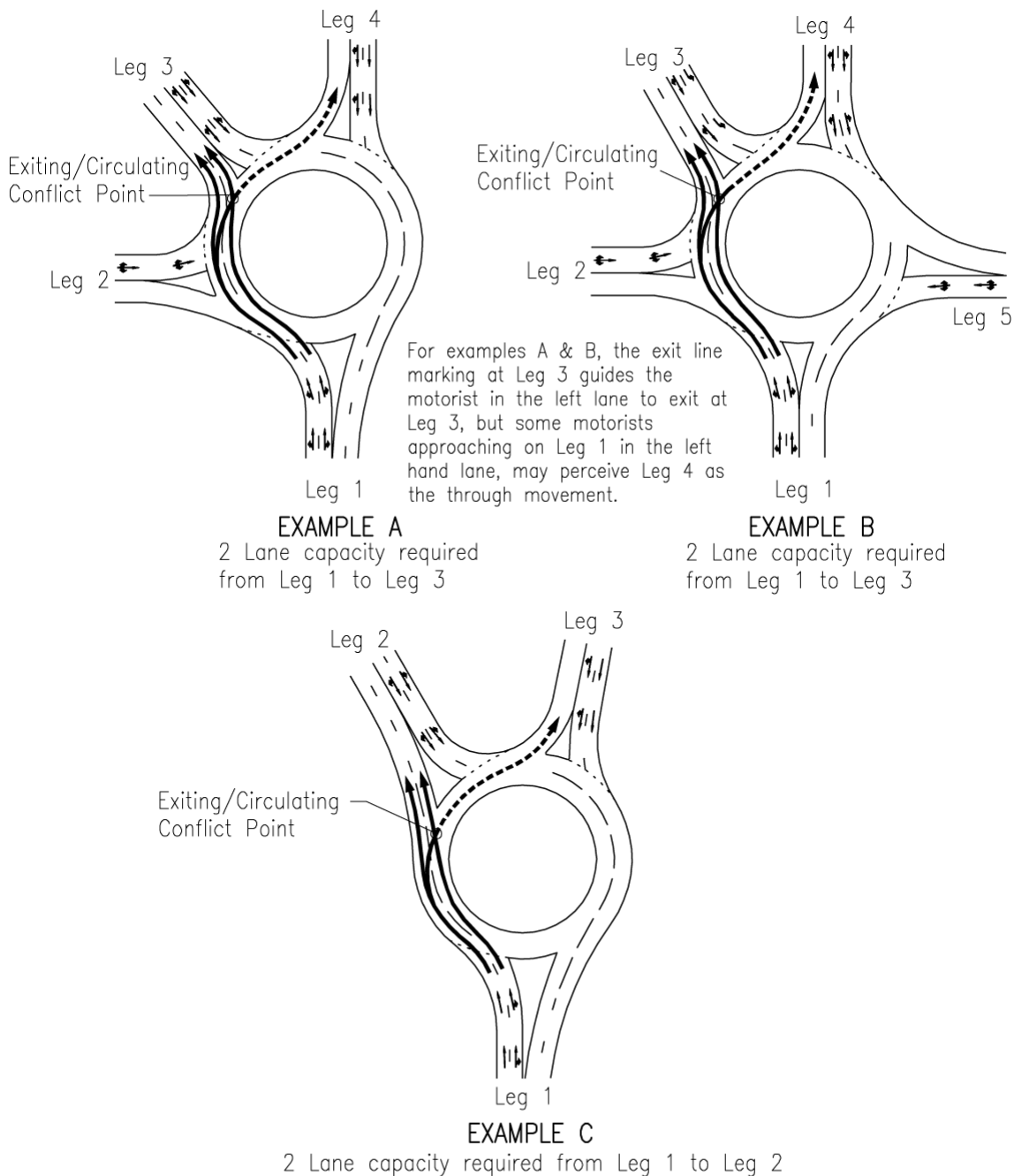

It is desirable to avoid the geometry shown in these examples for the design of new roundabouts. Multi-lane roundabouts with legs aligned at approximately 90° angles are preferred.

**Figure 14.5** Appropriate lane choice can be difficult to determine on multi-lane roundabouts with some or all legs aligned at angles substantially more or less than 90°

### Single lane exits adjacent to two circulating lanes

For multi-lane roundabouts, the standard exit line marking treatment alone does not appropriately allow for single lane exits adjacent to two circulating lanes in all cases. This typically occurs in the following instances:

- two-lane capacity is required from an entry leg to exits beyond the second exit leg;
- two-lane capacity is required for a right-turn; and
- two lane capacity is required for a through movement from an entry leg and a left-turn leg is present at a substantial distance from the entry leg

As a consequence of providing two-lane capacity from Leg 1 to Leg 4 of Example A in Figure 14.6, there is a requirement to drop a lane at the exit preceding Leg 4 (i.e. Leg 3 must be a single lane exit as shown). This helps mitigate exiting/circulating accidents at Leg 3 for traffic coming solely from Leg 1. However a problem still exists, as motorists entering from Leg 4 or Leg 5 and exiting at Leg 3 are required to cross the exit line marking as illustrated by Example B in Figure 14.6. A similar problem will occur for Examples C and D in Figure 14.6.

As a consequence of providing two lane capacity from Leg 1 to Leg 4 (of Example A in Figure 14.6), there is a requirement to provide motorists entering from Leg 4 or Leg 5 and destined for Leg 3 with an opportunity to get to the outer lane (and avoid a lane change at the exit). This can be achieved by using “spiral” continuity line marking as shown in Examples A and B of Figure 14.7. Examples C and D of

Figure 14.7 illustrate this same concept for a four legged and a three legged, multi-lane roundabout respectively.

For Examples C and D of Figure 14.7, there are also spirals adjacent Legs 4 and 3 respectively. For these examples, the “spiral” line marking also provides the driver already circulating on the roundabout with an opportunity to exit in either the left or right hand lane of Leg 1. This is especially important were there are downstream accesses on Leg 1. The ability to exit in either lane will minimise lane changes for drivers turning into downstream accesses.

“Spiral” line-marking, however does not completely resolve driver confusion with regard to negotiating these roundabouts. For some paths through the roundabout, drivers will need to cross the continuity line, for other paths they will need to follow it. Examples of this are described below:

- Examples A and B of Figure 14.7
  - When travelling from Leg 1 to Leg 4 in the inner lane, a motorist is to cross the continuity line;
  - When travelling from Leg 5 to Leg 3 or from Leg 4 to Leg 3, a motorist must follow the continuity line;
  - When travelling from Leg 5 to Leg 5 (i.e. a u-turn from Leg 5), a motorist is to cross the continuity line; and
  - When travelling from Leg 5 to Leg 4 or from Leg 4 to Leg 4 (i.e. a u-turn from Leg 4), a motorist can either cross or follow the continuity line.
- Example C of Figure 14.7

- o When travelling from Leg 1 to Leg 4 on the inner lane, a motorist is to cross the continuity line;
- o When travelling from Leg 4 to Leg 3, a motorist is to follow the continuity line;
- o When travelling from Leg 3 to Leg 3 (i.e. a u-turn from Leg 3), a motorist is to cross the first continuity line, then follow the second continuity line; and
- o When travelling from Leg 4 to Leg 4 (i.e. a u-turn from Leg 4), a motorist can either follow or cross the continuity line.
- Example D of Figure 14.7
  - o When travelling from Leg 1 to Leg 3 on the inner lane, a motorist is to cross the continuity line;
  - o When travelling from Leg 2 to Leg 2 (i.e. a u-turn from Leg 2), a motorist is to cross the first continuity line, then follow the second continuity line;
  - o When travelling from Leg 3 to Leg 2, a motorist is to follow the continuity, and
  - o When travelling from Leg 3 to Leg 3 (i.e. a u-turn from Leg 3), a motorist can either follow or cross the continuity line.

It is very difficult to advise drivers of the above requirements for all movements through these roundabouts, particularly with regard to when/how a driver is required to follow the spiral line markings (i.e. change from the inner circulating lane to the outer circulating lane for the movements above). Advance intersection direction signs do not show the required action in this case. For this reason, drivers faced with the “spiral” line marking may be confused as to whether to cross the “spiral” line marking or not.

**For the above reasons, two-lane capacity from an entry leg to an exit beyond the second exit leg is undesirable and should only be considered for existing roundabouts where there is a capacity problem. New roundabouts should be designed so that there is no need for the use of “spiral” line marking.**

**“Spiral” line making should only be considered as a solution to minimising operational problems on existing roundabouts where no other solution is feasible. Careful consideration needs to be given to the use/provision of “spiral” markings and, in all cases, advice should be sought from the Director (Traffic Engineering and Road Safety [TERS]) of Main Roads’ Traffic and Road Use Management (TRUM) Division prior to their installation.**

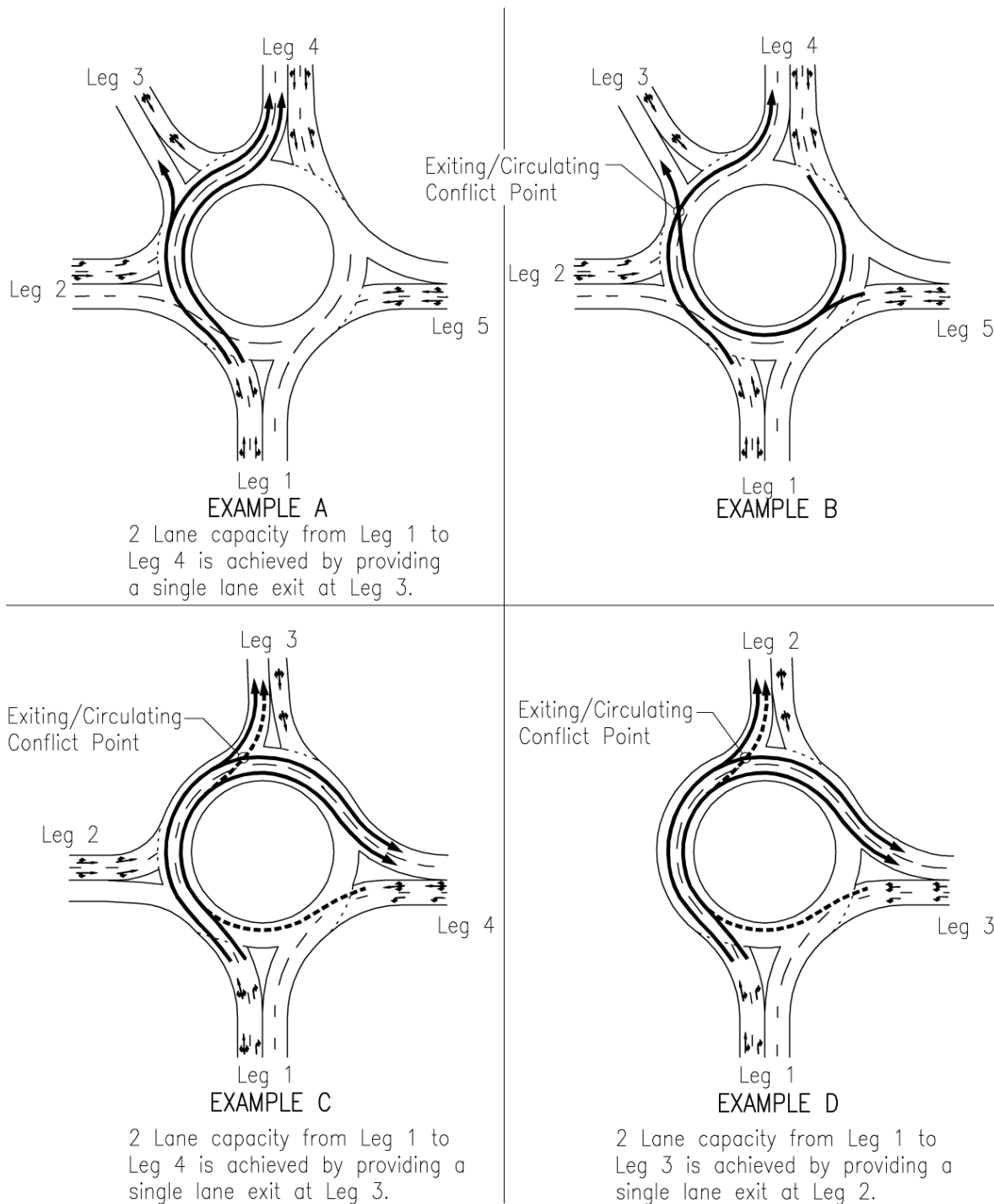

The geometry in these examples should not be used for the design of new roundabouts. If the examples shown in this figure were existing roundabouts, they would require 'spiral' line marking. Without the use of 'spiral' line marking, exiting/circulating conflicts are compounded at single lane exits adjacent to two circulating lanes.

**Figure 14.6 Examples showing potential conflicts arising without the "spiral" line marking system**

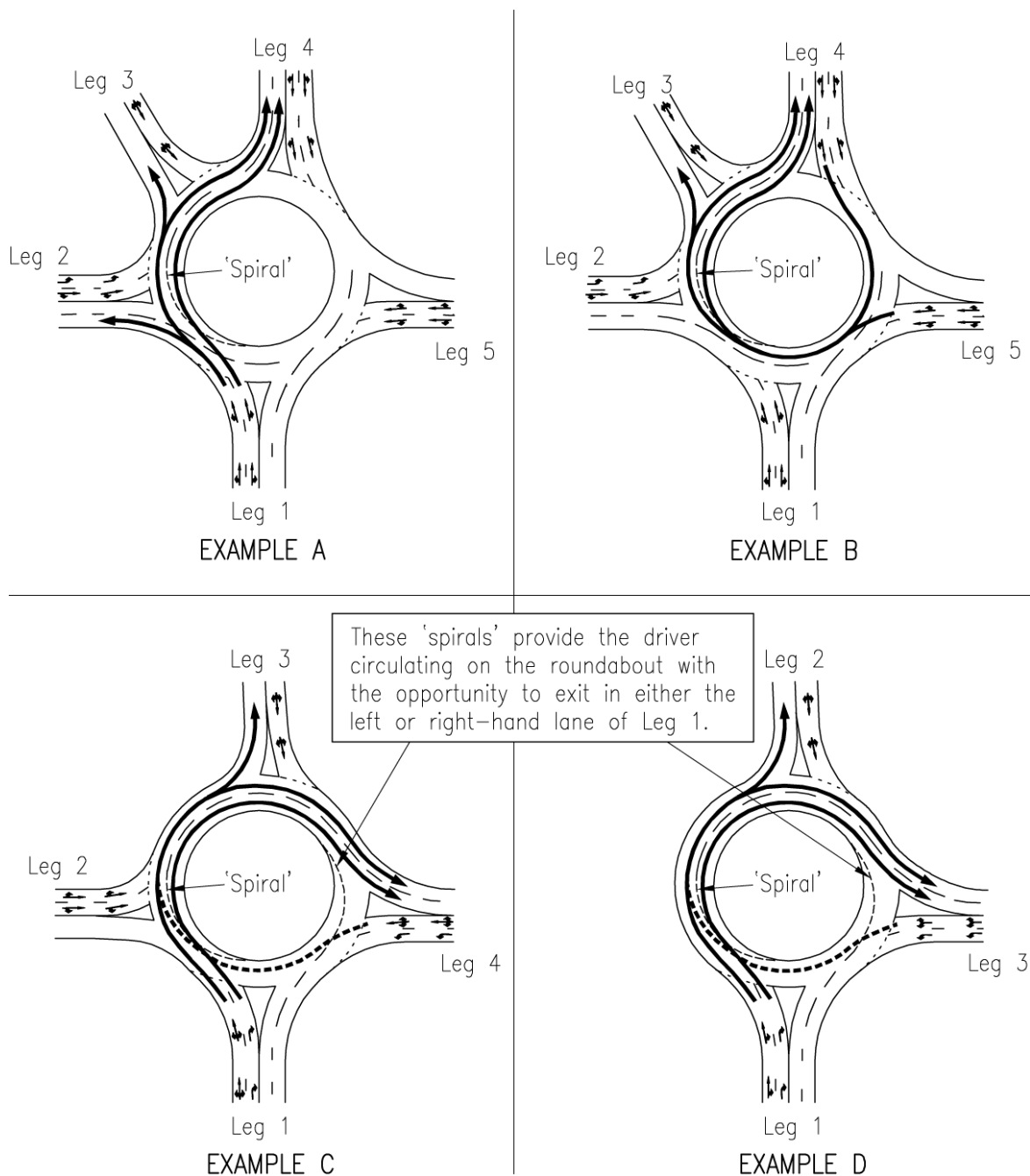

The geometry in these examples should not be used for the design of new roundabouts. These examples show the use of 'spiral' linemarking which is required to help guide motorists onto single lane exits adjacent to two circulating lanes. 'Spirals' are generally only suitable for retrofitting to existing roundabouts.

**Figure 14.7** Examples showing the use of the "spiral" line marking system for the examples shown in Figure 14.6



## 14.4 Number of roundabout lanes

In general, the number of roundabout lanes (entry, circulating and exit lanes) provided should be limited to the minimum number that achieves the desired capacity and operating requirements for the projected future traffic volumes. This is because the rates of several types of accidents at roundabouts increase with an increase in the number of lanes provided. Also, providing more lanes than necessary means construction costs will be unnecessarily high.

For the reasons given above, it is desirable to limit the number of circulating lanes to a maximum of two.

A single lane roundabout may be provided initially and upgraded in the future (say beyond 10 years) to a dual lane facility as traffic volumes dictate. In cases where this is applicable, the outside diameter of the roundabout and the left side approach and departure lane edges should be designed in the ultimate dual lane location.

### 14.4.1 Number of circulating lanes

The number of circulating lanes from any particular approach must be equal to or greater than the number of entry lanes on that approach. It is not essential to provide the same number of circulating lanes for the entire length of the circulating carriageway as long as the appropriate multi-lane exits are provided prior to reducing the number of circulating lanes. For examples of these treatments, refer to the Guide to Pavement Markings (QDMR, 2001).

### 14.4.2 Number of exit lanes

The number of exit lanes must not be greater than the number of circulating lanes. On multi-lane roundabouts, the number of exit lanes is based on the lane usage as determined by the pavement arrows on the approaches. Where no pavement arrows are shown, the number of exit lanes should equal the number of circulating lanes prior to the exit.

### 14.4.3 Left-turn slip lanes

Provision of a left-turn slip lane is beneficial on approaches where a significant proportion of the traffic turns left. In some cases, the use of a left-turn slip lane can avoid the need to build an additional entry lane.

There are two design options for the provision of left-turn slip lanes as shown in Figure 14.8 and Figure 14.9. Figure 14.8 shows a left-turn slip lane with a high entry angle and give way sign on the adjacent departure carriageway. Figure 14.9 shows a left-turn slip lane merging onto the adjacent departure carriageway. This design provides better operational performance than the design in Figure 14.8, but is more expensive to construct.

Left-turn slip lane geometry should either meet the criteria shown in Figure 14.8 or in Figure 14.9. It should not be somewhere in between (i.e. a free left-turn slip lane comprising a single radius return without an acceleration lane). This is so that the observation angle criterion described in Chapter 13 of this manual is achieved.

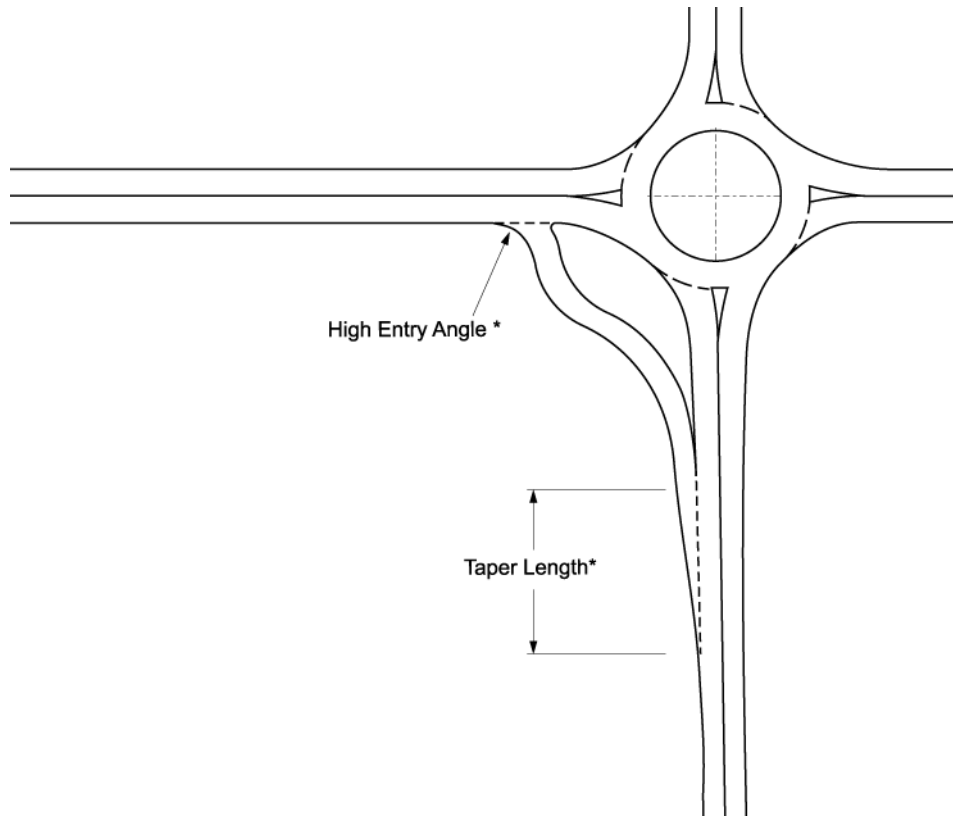

Figure 14.8 Configuration of a left turn slip lane with a high entry angle

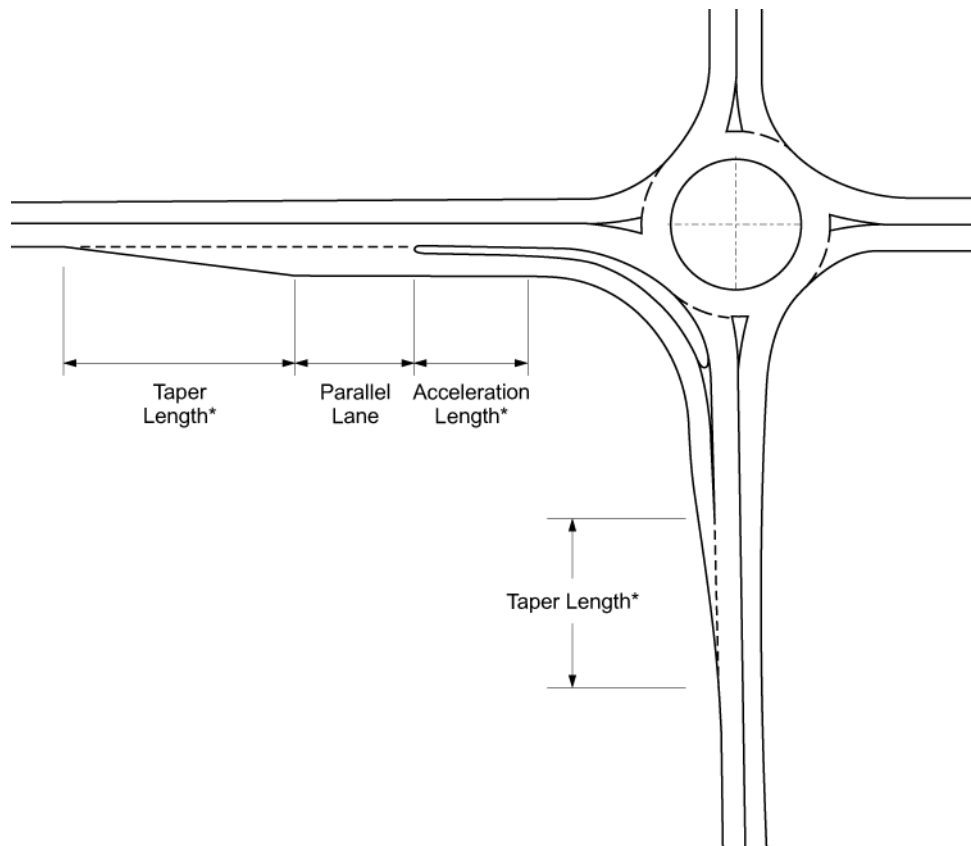

Figure 14.9 Configuration of a left turn slip lane with an acceleration lane

## 14.5 Roundabout diameter

Larger roundabouts enable better geometry to be designed. Increasing the diameter of a roundabout usually enables provision of better approach geometry which leads to a reduction in vehicle approach speeds. An increase in roundabout diameter will also usually provide a reduction in the angle formed between the entering and circulating vehicle paths thus reducing the relative speed between these vehicles which in turn lowers the entering/circulating vehicle accident rate.

Larger roundabouts also provide greater separation between adjacent conflict areas and make it easier for entering drivers to determine whether vehicles, already on the circulating carriageway, are exiting or continuing on around the circulating carriageway.

In general, roundabouts in areas with high desired speeds need larger diameters to enable better approach geometry to be designed to reduce the high approach speeds. The design of these roundabouts is more critical than that for roundabouts located in areas with low desired speeds.

Table 14.2 and Table 14.3 give an initial guide for the selection of a minimum roundabout central island diameter. These criteria have been based on limiting the values of a number of parameters to achieve the lowest acceptable balance between safety, practical construction and cost. Use of larger diameters will enable greater safety benefits to be obtained.

The criteria in Table 14.2 and Table 14.3 are based on the following:

- The roundabout comprises four legs;

- Each leg has the same desired speed prior to the roundabout;
- Each leg is at 90° to adjacent legs;
- Good geometry (that limits approach and entering speeds) can be provided on each leg;
- Kerbing exists on both sides of all carriageways; and
- There are no medians on any of the approaches.

If any of the above do not apply (which is usual), the values given in Table 14.2 and Table 14.3 will need to be adjusted to suit the specific requirements. Generally, the roundabout diameter will need to be increased to allow for any of the following conditions:

- The roundabout has more than four legs;
- The angle between any adjacent roundabout leg is considerably more or less than 90°;
- There are shoulders and no kerbing on some or all of the carriageways;
- There are medians on some of the approaches;
- The circulating carriageway is of greater width than that shown in Table 14.2 and Table 14.3; or
- Other considerations apply (e.g. the roundabout will form an overpass or underpass with a highway or motorway).

**Table 14.2 Initial selection of minimum central island diameters of single lane roundabouts**

Desired driver speed prior to approach carriageway (km/h)	Minimum central island diameter (m)	Circulating carriageway width (m)	Treatments required to reduce vehicle speed prior to the entry curve *
40	10	7.6	No
50	10	7.6	No
60	15	7.1	No
70	20	6.7	No
80	25	6.5	Desirably
90	25	6.5	Yes
100	25	6.5	Yes
110	25	6.5	Yes

\* Refer to Section 14.8.1, 'Entry Curve'.

**Table 14.3 Initial selection of minimum central island diameters of two lane roundabouts**

Desired speed prior to the roundabout (km/h)	Minimum central island diameter (m)	Circulating carriageway width (m)	Treatments required to reduce vehicle speed prior to the entry curve *
40	15	11.1	No
50	15	11.1	No
60	25	10.3	No
70	30	10.0	No
80	40	9.6	Desirably
90	40	9.6	Yes
100	40	9.6	Yes
110	40	9.6	Yes

\* Refer to Section 14.8.1, 'Entry Curve'.

Generally, the minimum values given in Table 14.2 and Table 14.3 can be reduced to allow for any of the following conditions:

- The roundabout has three legs; or
- The desired speeds on some of the approaches are significantly lower than that of others.

The roundabout diameter should be limited to maximum of 200m. Larger diameters will encourage high circulating speeds and may encourage wrong way movements if drivers perceive that the time taken to traverse the roundabout is too long.

## 14.6 Roundabout roadway widths

### 14.6.1 Design vehicle and vehicle swept paths

The design vehicle and consequently the swept path requirements may be different for the various paths through the roundabout. For example, the straight through movement at a particular roundabout may have to cater for 25m B-doubles whereas the left and right turning movements may only need to cater for single unit trucks. This can occur for the any of the following reasons:

1. Particular heavy vehicles can be restricted to certain routes and therefore their turning movements at a roundabout are restricted.
2. It is desirable to restrict movements of certain heavy vehicles on some legs.
3. The volumes of a particular heavy vehicle type are extremely low on particular turning movements. In this case, encroachment areas may be provided which allow a smaller width of circulating carriageway to be used.

Because travel through roundabouts involves complex reverse-turn movements, particular care is needed in the use of simple turning path templates to achieve a satisfactory layout. A more accurate result is obtained by using a computer plot of the design vehicle's swept path on an assumed travel path through the critical turning movements. The computer program VPATH is an example of a computer program which may be used for this purpose. This program may also be used to check the ability of a roundabout to cater for any check and/or over-dimensional vehicles which may need to be accommodated.

### 14.6.2 Width of circulating carriageway

The width of the circulating carriageway depends on several factors, the most important of which are the number of circulating lanes and the radius of vehicle swept paths within the roundabout.

#### Single lane roundabouts

The circulating carriageway width of single lane roundabouts should cater for the movement of the largest vehicle normally expected to use the roundabout (i.e. the

design vehicle). An offset of 0.6m from each edge of the vehicle swept path to the lane edge/kerb should be provided. Initial selection of circulating carriageway widths required to cater for one heavy vehicle turning right using the above offsets are shown in Table 14.4. These widths need to be checked by using a plot of the design vehicle's swept path (e.g. using VPATH) using an assumed travel path through the critical turning movements.

**Table 14.4 Initial selection of single lane roundabout circulating carriageway widths**

<sup>1</sup> Central island radius (m)	<sup>2</sup> Width required for design vehicle (m)				
	12.5m Single Unit Truck	19m Semi-Trailer	25m B-Double	Type 1 Road Train	Type 2 Road Train
5	-	9.4	-	-	-
6	-	9.1	10.1	-	-
8	6.9	8.6	9.6	11.1	-
10	6.5	8.2	9.1	10.6	12.6
12	6.2	7.8	8.7	10.1	12.1
14	6	7.4	8.3	9.7	11.6
16	5.8	7.2	8	9.3	11.1
18	5.6	6.9	7.7	8.9	10.7
20	5.4	6.7	7.4	8.6	10.3
23	5.3	6.4	7	8.2	9.8
26	5.1	6.1	6.8	7.8	9.4
30	5	5.9	6.4	7.4	8.8
35	5	5.6	6	6.9	8.2
40	5	5.4	5.8	6.6	7.8
45	5	5.2	5.6	6.3	7.4
50	5	5.1	5.4	6.1	7.1
60	5	5	5.2	5.7	6.5
70	5	5	5	5.4	6.2
80	5	5	5	5.2	5.9

Notes:

1. Radius used for the purpose of determining vehicle path.
2. The widths given in this table are based on right turning vehicle paths with a 0.6m offset to the central island and a 0.6m offset to the outer edge of the circulating carriageway.

This check should be performed because the widths in Table 14.4 may not be sufficient for all possible combinations of roundabout geometry and turning movements. In addition, if the design

vehicle is only travelling straight through the roundabout, the widths may be unnecessarily large.

### Dual Lane Roundabouts

The circulating carriageway width of dual lane roundabouts would normally need to cater for the movement of the largest vehicle normally expected to use the roundabout (i.e. the design vehicle) alongside a passenger car. A distance of 1.2m from the edge of both vehicle swept paths and a distance of 0.6m from the edge of the vehicle paths to the lane edge/kerb should be provided. The heavy vehicle in these cases will have to travel part way into the adjacent lane in order to complete the manoeuvre.

Initial selection of circulating carriageway widths required to cater for one heavy vehicle turning right alongside a passenger car using the offsets described above are shown in Table 14.5. These values are nominally 3.2m greater than those given for single lane roundabouts. The value of 3.2m allows for a 2m wide passenger car with an additional 0.6m clearance on either side. The widths given in Table 14.5 should be checked by using computer plots of the design vehicle's swept paths on assumed travel paths through the critical turning movements. This is for the same reasons as those given for single lane roundabouts.

There are cases in which the use of the values of circulating carriageway widths in Table 14.4 and Table 14.5 will lead to inadequate amounts of deflection and entry curvature being obtained. In these cases, where it is uneconomical to increase the diameter of the central island, it is preferable to reduce the circulating carriageway widths to provide adequate entry curvature and deflection. This will

result in larger vehicles encroaching onto the splitter islands and central island. These encroachment areas will need to be specially constructed. Typical cross-sections of these encroachment areas are shown in Figure 14.10.

**Table 14.5 Initial selection of two lane roundabout circulating carriageway widths**

<sup>1</sup> Central island radius (m)	<sup>2</sup> Width required for design vehicle (m)				
	12.5m Single Unit Truck	19m Semi-Trailer	25m B-Double	Type 1 Road Train	Type 2 Road Train
8	10.1	-	-	-	-
10	9.7	11.4	-	-	-
12	9.4	11	11.9	-	-
14	9.2	10.6	11.5	12.9	-
16	9	10.4	11.2	12.5	14.3
18	8.8	10.1	10.9	12.1	13.9
20	8.6	9.9	10.6	11.8	13.5
23	8.5	9.6	10.2	11.4	13
26	8.3	9.3	10	11	12.6
30	8.1	9.1	9.6	10.6	12
35	8	8.8	9.2	10.1	11.4
40	7.9	8.6	9	9.8	11
45	7.8	8.4	8.8	9.5	10.6
50	7.7	8.3	8.6	9.3	10.3
60	7.6	8.1	8.4	8.9	9.7
70	7.5	7.9	8.2	8.6	9.4
80	7.4	7.8	8	8.4	9.1

Notes:

1. Radius used for the purpose of determining vehicle path.
2. The widths in this table are nominally 3.2m greater than the widths given for single lane roundabouts for the reasons given in the body text.

### 14.6.3 Entry and exit widths

Entry and exit widths directly affect the location of the vehicle swept paths through the roundabout. Generally, smaller widths result in smaller vehicle path radii on the entry curve and more deflection through the roundabout thus decreasing speeds through the roundabout.

Generally, lane widths will fall within the range of 3.4m to 4.0m. Exceptions are for

kerbed single lane entries and exits where a minimum width of 5.0m between kerbs is usually provided to allow traffic to pass a disabled vehicle.

Entry and exit widths need to be checked for vehicle swept paths to ensure that the design vehicle is properly catered for. Again, a more accurate result is obtained through the use of a computer plot of the design vehicle's swept path (eg using VPATH) on an assumed travel path through the critical turning movements.

There are cases in which the use of adequate entry lane widths for large vehicles will lead to inadequate entry curvature (e.g. providing for road trains on rural roundabout approaches). In these cases, it is preferable to reduce the entry lane widths to provide adequate curvature. Suitably constructed encroachment areas will then need to be constructed to cater for the movement of large vehicles. Typical encroachment areas for this purpose are shown in Figure 14.10. The Type B treatment (with kerb) shown in Figure 14.10 is best for this purpose.

#### 14.6.4 Over Dimensional (OD) vehicles

Over Dimensional (OD) vehicles are those having greater than the maximum legal dimensions for vehicles and may be permitted to operate on major arterial routes from time to time. Roundabouts on major arterial routes need to cater for these vehicles. Because the size of these vehicles can vary greatly, it is not essential that such vehicles be able to traverse the intersection without encroaching onto the central island area and/or the approach splitter islands. These encroachment areas need to be specially constructed so that they possess the following properties:

- they should be constructed of load bearing pavement;
- where kerbs are expected to be traversed, semi-mountable or fully mountable kerbs should be used;
- drainage pits should be located clear of these areas, or if this is not practicable they will need to be suitably reinforced to take heavy wheel loads; and
- road furniture must not be placed in these areas.

Figure 14.10 illustrates how to provide for an over-dimensional vehicle turning from north to east (and vice versa).

## 14.7 Curvature and deflection

### 14.7.1 Entry curve

**The entry curve is one of the most important geometric parameters to be designed at roundabouts.** A left hand entry curve must be used. The provision of an appropriate radius on the entry curve encourages drivers to slow down before reaching the roundabout. This is similar to the use of horizontal curves to transition from a horizontal element with a high operating speed to a substandard curve. Care should be taken to ensure that the entry curve radius is not so large as to result in an unacceptably high speed entry onto the circulating carriageway. Figure 14.11 shows desirable and undesirable approach geometry.

The entry curve radius should be chosen such that the 85<sup>th</sup> percentile entry speed is limited to a maximum of 60km/h. Entry speed is calculated by the vehicle path and speed prediction model given in Appendix 14B. (Note: The speed model in Appendix 14B is different to the operating speed

model in Chapter 6 of this manual). Entry speed can be calculated manually using the models given in Appendix 14B (but this is not recommended due to its complexity) or by using the ARNDT computer program (refer to Section 14.9). In areas of high desired speeds, it is recommended that the maximum vehicle path radius on the entry curve be limited to 60m to obtain the maximum entry speed.

Figure 14.12, Figure 14.13 and Figure 14.14 all show how entry geometry (i.e. curvature) can be improved.

### 14.7.2 Deflection through roundabouts

Adequate deflection of the paths of vehicles entering a roundabout is an important factor influencing their safe operation. It is achieved by adjusting the geometry of the approach carriageway and by ensuring that “through” vehicle paths are significantly deflected by one or more of the following means:

- the alignment of the approach carriageway and the shape, size and position of approach splitter islands;
- the provision of a suitably sized and positioned central island; and/or
- the introduction of a staggered or non-parallel alignment between any entry and exit.

It is recommended that the deflection criteria given in this section be adopted on all roundabouts except those in constrained locations. In these constrained cases, if a left hand entry curve is adopted to limit the 85<sup>th</sup> percentile entry speed to a maximum of

60km/h as discussed in Section 14.7.1 and all other standards in this chapter are met, the need to obtain the required deflection through the roundabout is reduced because:

1. Slowing vehicles prior to the circulating carriageway by the entry curvature ensures the speed of vehicles on the circulating carriageway is minimised; and
2. Lower total accident rates occur by slowing vehicles prior to the circulating carriageway using entry curvature rather than on the roundabout using deflection alone.

### Deflection at roundabouts with one circulating lane

The required vehicle deflection for a single lane roundabout is illustrated in Figure 14.15. In this case, the central island size and location, and the approach geometry, are the controlling factors.

### Deflection at roundabouts with two or three circulating lanes

For multi-lane roundabouts it is generally difficult to achieve the full deflection recommended above for single lane roundabouts. Where this is the case, it is acceptable for the deflection to be measured using a vehicle path as illustrated in Figure 14.16. This differs from that used at single lane roundabouts in that the fastest (maximum radius) vehicle path is assumed to start in the left entry lane, cut across the circulating lanes and pass no closer than 1.5m to the central island before exiting the roundabout in the left lane.



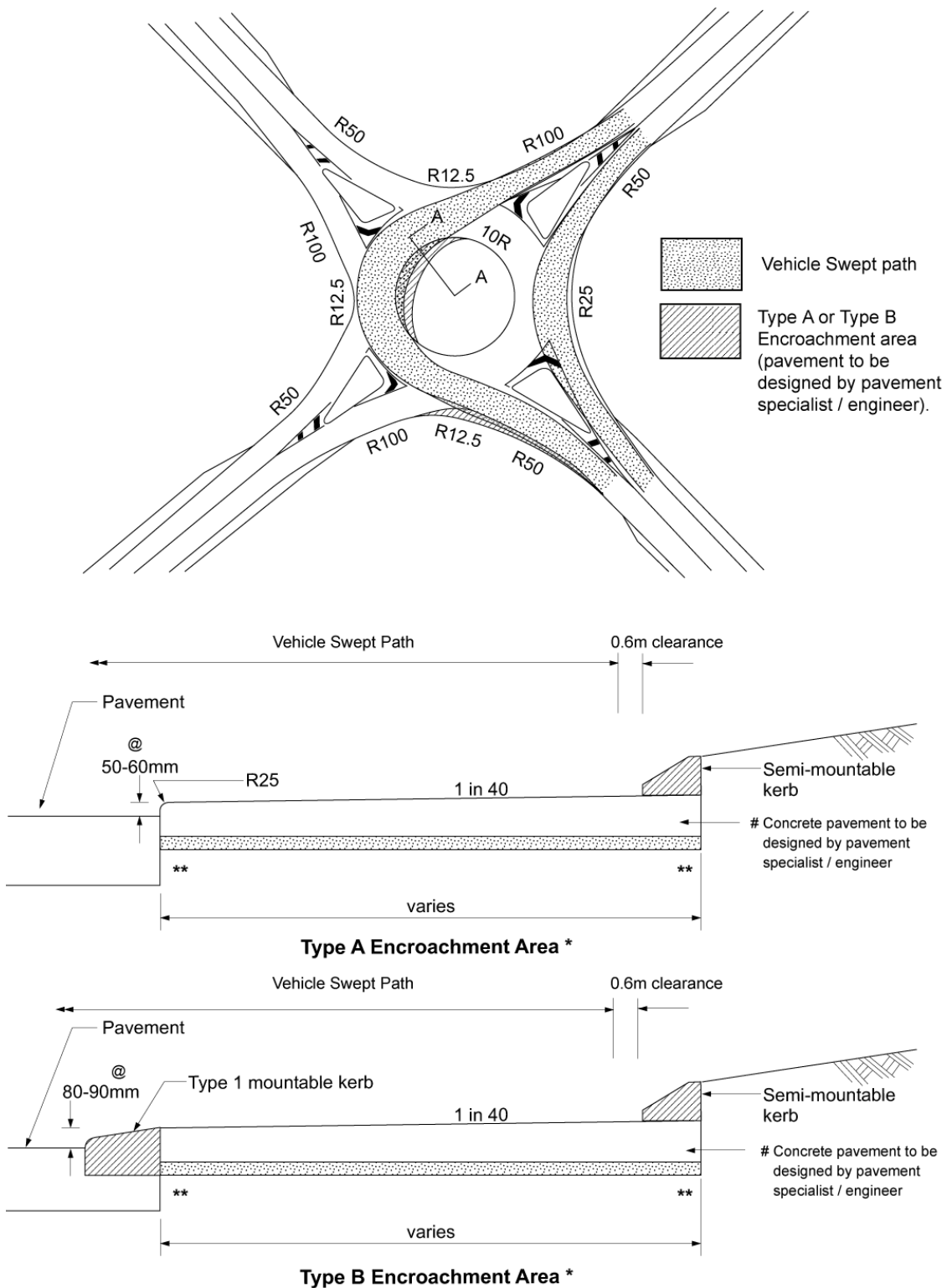

- \* Alternative profiles which discourage drivers of passenger cars to mount but enable relatively smooth passage by heavy vehicles.
- \*\* Subsoil drainage may be required in these zones.
- # Fully mountable concrete apron to be designed to withstand heavy vehicle.
- @ The height differential should always be within this range. This may mean that overlays can not be used in maintenance/rehabilitation operations - milling and replacing the pavement/wearing course may be required instead.

Figure 14.10 Encroachment areas at roundabouts

14

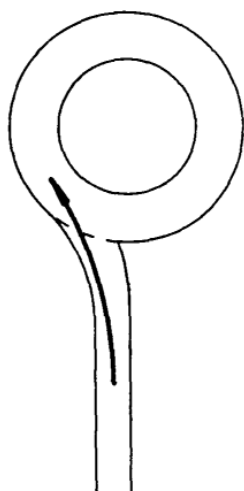

Left entry curve to minimise entry speed and relative speed between entering and circulating vehicles

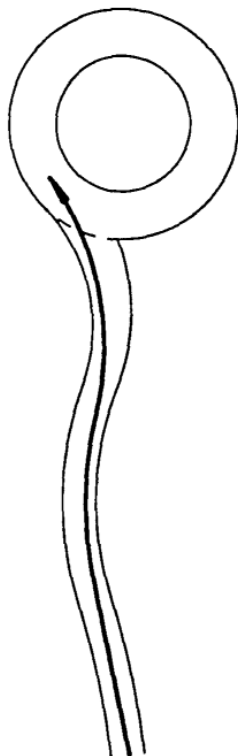

Successive reverse curves to limit decrease in speed between successive horizontal elements in high speed environments

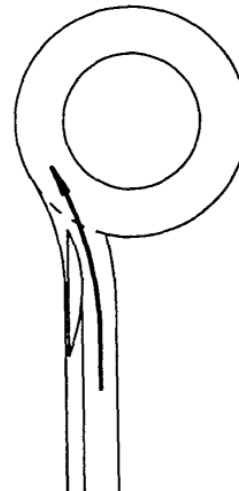

Provision of 'blisters' on wide carriageways to minimise entry speed and relative speed between entering and circulating vehicles

EXAMPLES OF GOOD APPROACH GEOMETRY

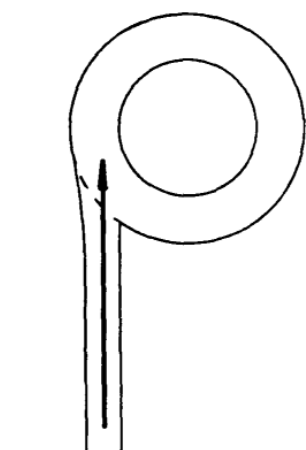

Straight entry (High entry speed)

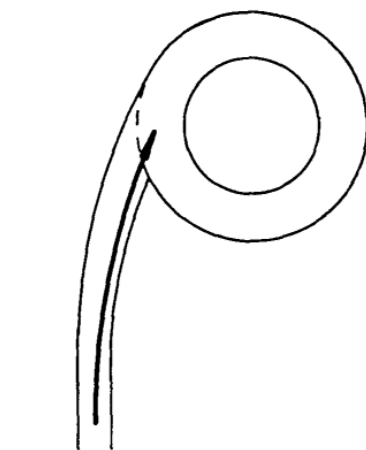

Right entry curve

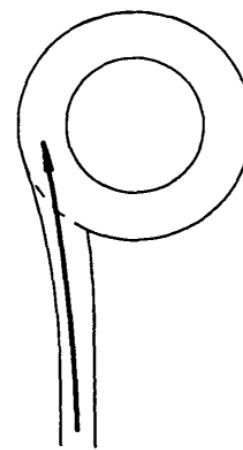

Large radius left entry curve (High entry speed)

EXAMPLES OF UNDESIRABLE APPROACH GEOMETRY  
NOT TO BE USED ON NEW ROUNDABOUTS

Figure 14.11 Desirable and undesirable roundabout approach geometry

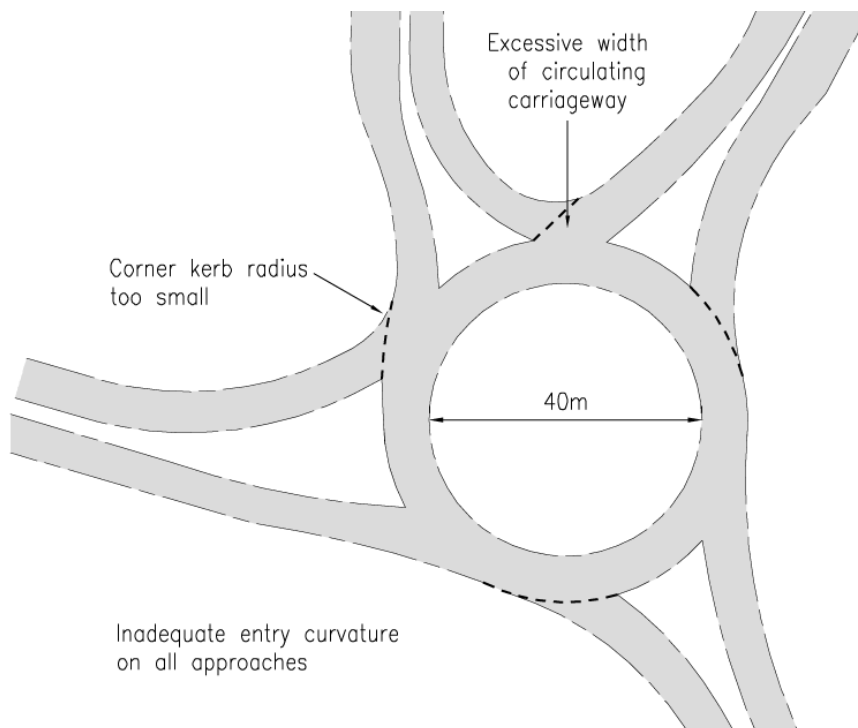

ORIGINAL DESIGN COMPRISING SUBSTANDARD GEOMETRY

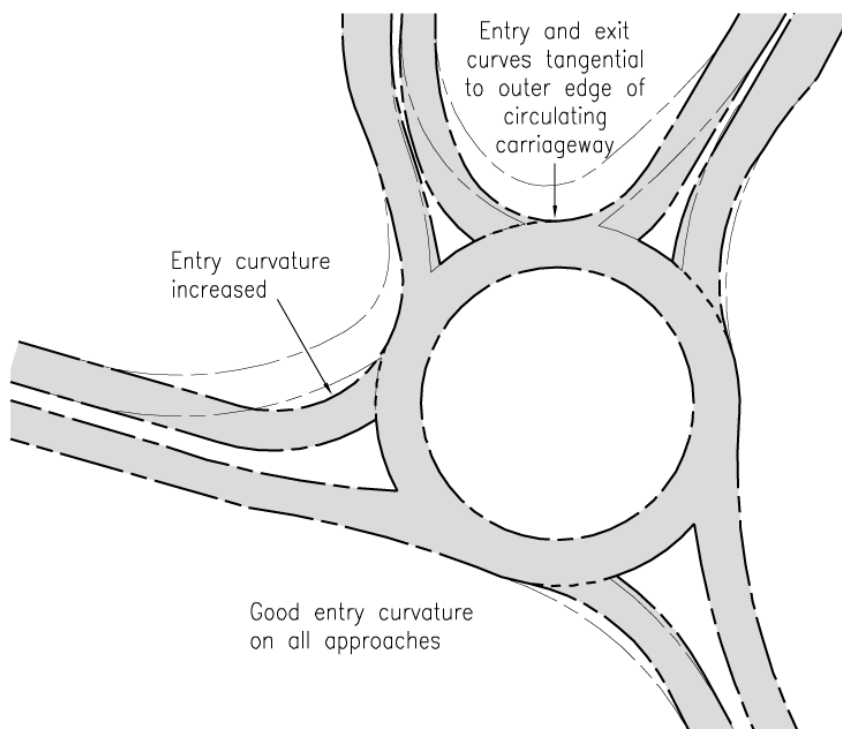

RECOMMENDED DESIGN WITH ACCEPTABLE GEOMETRY

Figure 14.12 Example 1 – design modifications to improve geometry

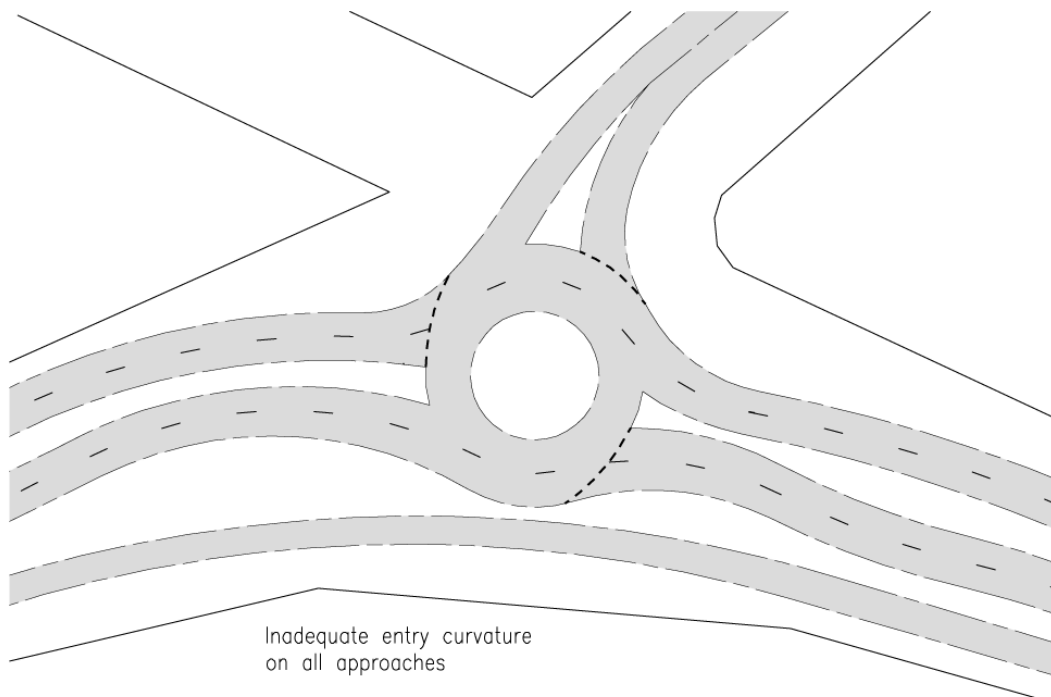

ORIGINAL DESIGN COMPRISING SUBSTANDARD GEOMETRY

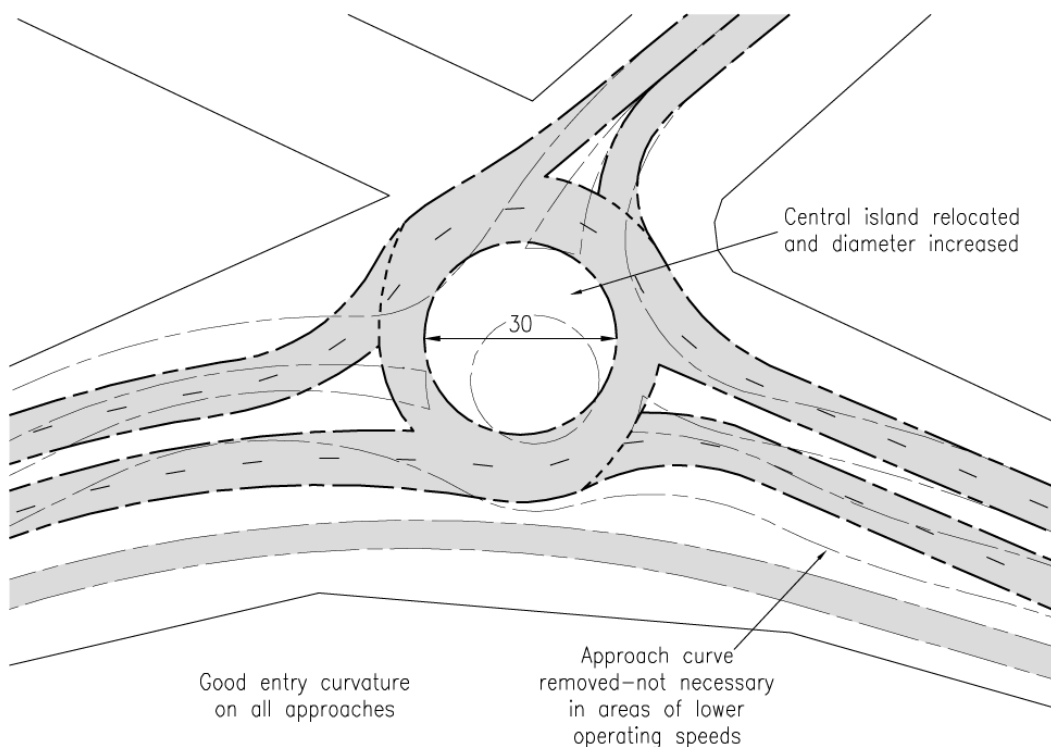

RECOMMENDED DESIGN WITH ACCEPTABLE GEOMETRY

**Figure 14.13 Example 2 – design modifications to improve geometry**

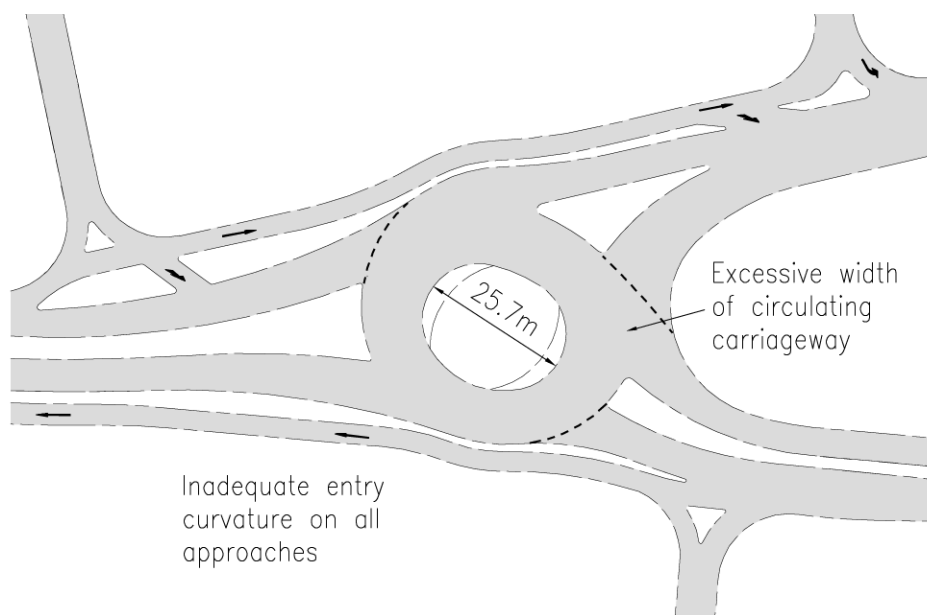

ORIGINAL DESIGN COMPRISING SUBSTANDARD GEOMETRY

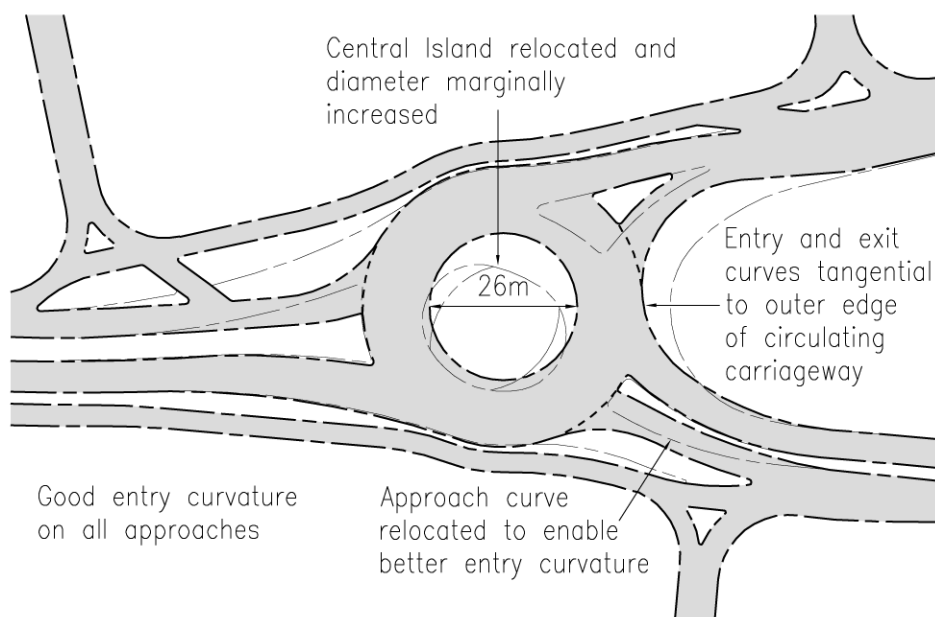

RECOMMENDED DESIGN WITH ACCEPTABLE GEOMETRY

**Figure 14.14 Example 3 – design modifications to improve geometry**

14

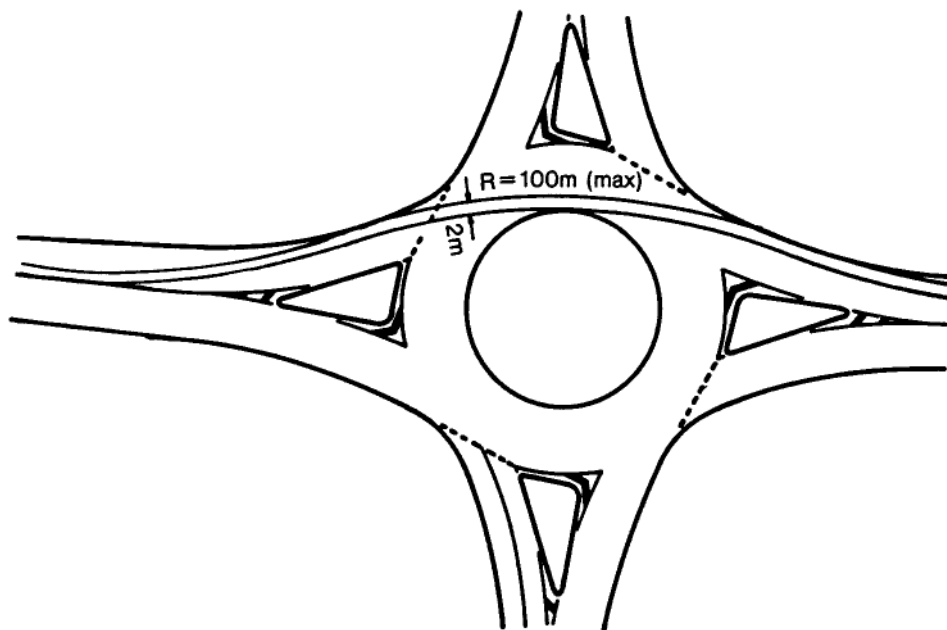

Figure 14.15 Illustration of the deflection criteria for a single lane roundabout

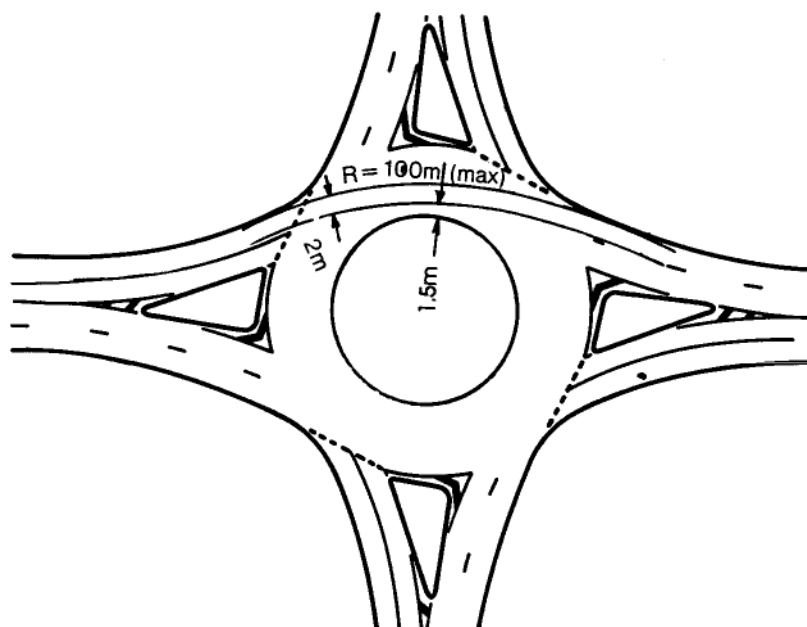

Figure 14.16 Illustration of the deflection criteria for a multi-lane roundabout

### 14.7.3 Exit curves

In areas where there are no pedestrians, the exit from a roundabout should be as easy to negotiate as practicable. After having been slowed down by the entry and circulating curves, vehicles should be able to accelerate on the exit. Therefore, the radius of the exit curve should generally be greater than the circulating radius. Ideally, a straight path tangential to the central island, as shown in Figure 14.17, is preferable for exiting vehicles (where there is negligible pedestrian activity), in contrast to the curved entering path.

In areas where there are pedestrians, the exit speed should be minimised. The best solution to minimise the exit speed is to provide a small radius exit curve. Figure 14.18 shows a desirable roundabout treatment where pedestrian crossings are required.

## 14.8 Speed and side friction parameters

This section discusses a number of important parameters that significantly affect accident rates at roundabouts. Maximum recommended values of these parameters are given in this Section. To calculate the actual values of these parameters for a given roundabout the designer can either:

- use the procedure in Appendix 14C which is based on the vehicle path and speed prediction models given in Appendix 14B (this is not recommended due to the complexity of the calculations). (Note: The speed model in Appendix 14B is different to the operating speed model in Chapter 6 of this manual); or

- use the computer program ARNDT which is discussed in Section 14.9 (this is the recommended method).

### 14.8.1 Maximum decrease in speed between successive horizontal elements

Single vehicle accident rates reduce as the decrease in speed between successive horizontal elements reduces. For this reason it is important to limit the decrease in speed between successive horizontal elements for all paths through the roundabout. Limiting the decrease in speeds between successive horizontal elements will also minimise sideswipe vehicle accident rates.

The maximum decrease in 85<sup>th</sup> percentile speeds between successive horizontal elements should be limited to the values given in the following sections.

#### Reverse curves and tangent to curves

For reverse curves and tangent to curves, the decrease in operating speed between elements should be limited to the following values:

1. For a right turn movement on or between horizontal geometric elements of the circulating carriageway, a maximum decrease in 85<sup>th</sup> percentile speed of 30km/h is deemed to be acceptable if the 85<sup>th</sup> percentile speed on the entry curve is less than 60 km/h.
2. All other locations - 20km/h.

For a horizontal geometric element on the circulating carriageway where it cannot be easily determined if the movement is through or right, assume it is a through movement and use 20km/h.

## Compound curves

For compound curves the decrease in speed between elements should be limited to 10km/h. Compound curves should comply with the requirements specified in Chapter 11 of this manual.

# 14

## Entry curve

The most critical application of these criteria is in checking the decrease in speed that occurs at the start of the entry curve in areas with high desired speeds (i.e. where the desired speed is greater than or equal to 80km/h - refer to Table 14.2 and Table 14.3). Potential decreases in speed of up to 60km/h can occur in these situations. One method to limit this decrease in speed is to provide a number of reverse curves before the entry curve (i.e. on the approach) to limit the maximum decrease in speed between horizontal geometric elements to 20km/h as discussed in Section 14.10.

Providing successive reverse curves on the approach is one method to mitigate the problems with a large decrease in speed on the entry curve. Alternative methods

include the provision of the following treatments:

- rumble strips;
- locally creating a lower desired speed by the use of treatments producing the impression of restriction to the driver (e.g. dense planting close to the edges of the approach carriageway [but must not hinder sight triangles]; narrower total cross section [but only on horizontal straights]; guide posts at decreasing spacing towards the roundabout);
- large advance warning signs;
- appropriate speed limit signs;
- pavement marking across carriageway;
- lighting;
- flashing lights; and/or
- appropriate run-out areas.

However, the effectiveness of all these treatments (including the provision of reverse curves) is not completely known.

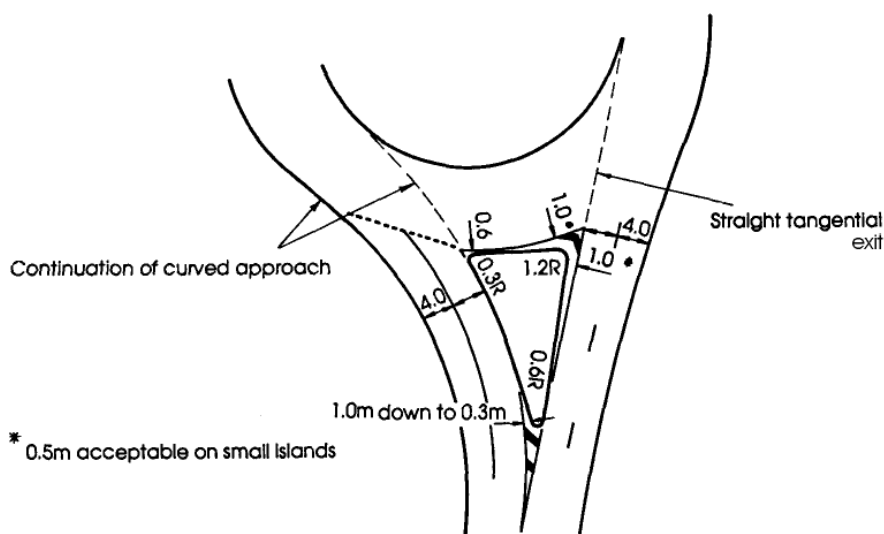
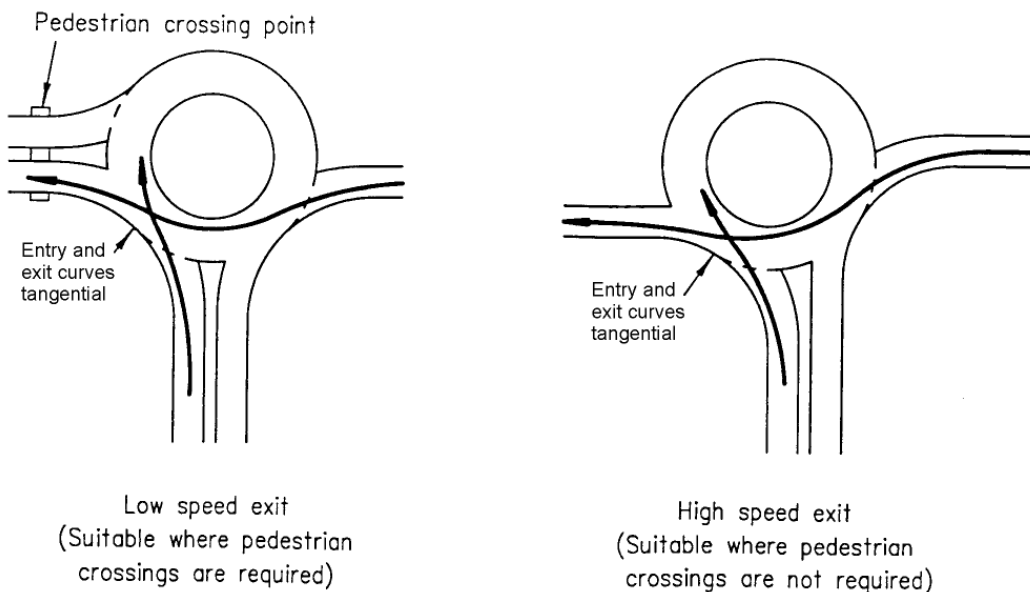
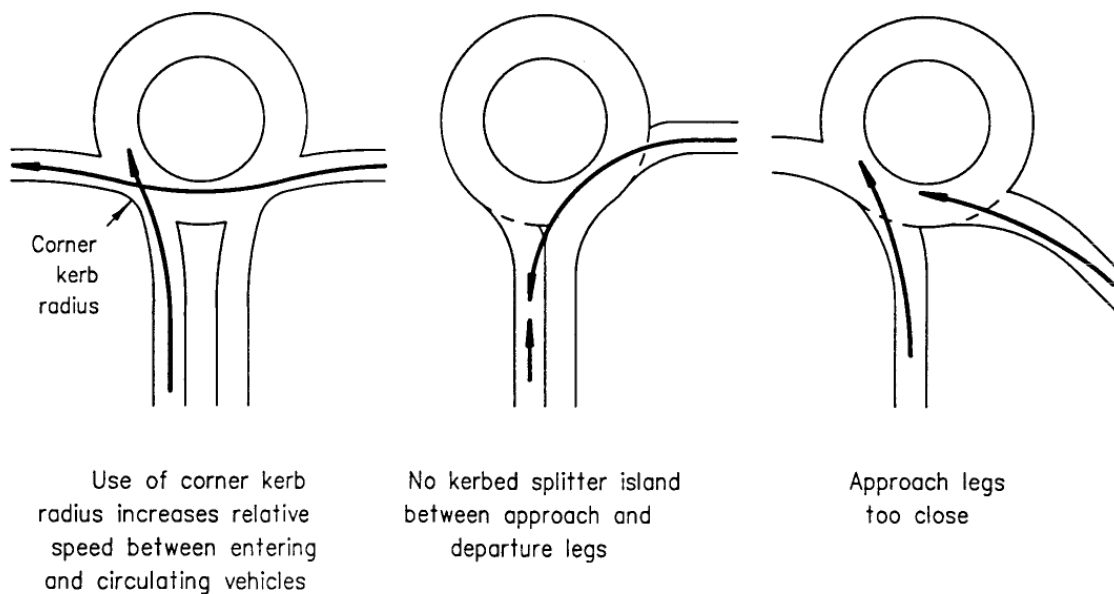

Figure 14.17 Typical roundabout entrance/exit conditions for urban areas





EXAMPLES OF GOOD SEPARATION BETWEEN LEGS



EXAMPLES OF UNDESIRABLE SEPARATION BETWEEN LEGS

**Figure 14.18** Examples showing desirable and undesirable separation between roundabout legs

### Circulating carriageway

Another area of the roundabout where the decrease in speed can be critical is at the start of the circulating carriageway. An excessive decrease in speed can occur if the radius of the circulating curve is considerably smaller than the entry curve. The entry curve radius may need to be reduced to limit the decrease in speed between the entry and the circulating curves. This will minimise single vehicle accident rates.

This problem is compounded for vehicles with high centres of gravity if a substantial decrease in speed is combined with adverse crossfall at this point. Such vehicles tend to overturn quite readily with this combination of geometry. Again, the best solution to minimise this problem is to provide adequate entry curvature to reduce vehicle speed before the circulating carriageway. Refer to Section 14.12 for the design of the crossfall of the circulating carriageway.

#### 14.8.2 Maximum entry speed

As discussed in Section 14.7.1, the entry curve radius should be chosen such that the 85<sup>th</sup> percentile entry speed is limited to a maximum of 60km/h.

#### 14.8.3 Potential relative speed of entering and circulating vehicles

The entering/circulating vehicle accident rate on any particular approach is largely related to the potential relative speed of entering and circulating vehicles. Minimising the potential relative speed of entering and circulating vehicles will minimise the entering/circulating vehicle accident rate. The potential relative speed

of entering and circulating vehicles should be limited to 50km/h.

The potential relative speed of entering and circulating vehicles on any particular approach can be reduced by:

1. Reducing the entry curve radius (refer Section 14.7.1);
2. Providing a smaller radius entry curve on the preceding approach leg (refer Section 14.7.1);
3. Providing greater deflection through the roundabout (refer Section 14.7.2);
4. Increasing the central island diameter (refer Section 14.5);
5. Providing more separation between legs (refer Section 14.11); and/or
6. Decreasing the entry and exit widths (refer Section 14.6.3).

The upper diagram of Figure 14.19 shows a single lane urban roundabout. The eastern and southern approach legs are in an area with a 60km/h desired speed and both have little entry curvature and deflection. The potential relative speed of entering and circulating vehicles on the southern leg is 67km/h. This high potential relative speed can produce high multiple vehicle accident rates between entering and circulating vehicles.

The lower diagram of Figure 14.19 shows the same roundabout with the central island relocated to obtain greater entry curvature and deflection. In addition, the width of the approach legs has been narrowed. The potential relative speed of entering and circulating vehicles on the southern leg is 37km/h for this layout. This is a considerable reduction in potential relative speed and will considerably lower the multiple vehicle accident rate between entering and circulating vehicles.

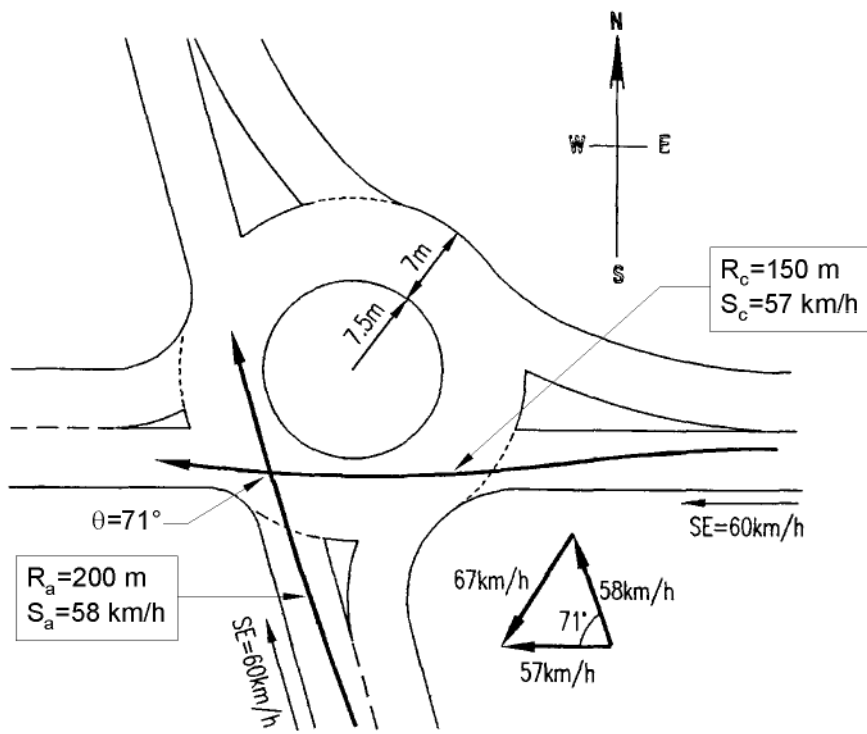

ADJACENT ROUNDABOUT APPROACHES  
WITH MINIMAL CURVATURE AND DEFLECTION

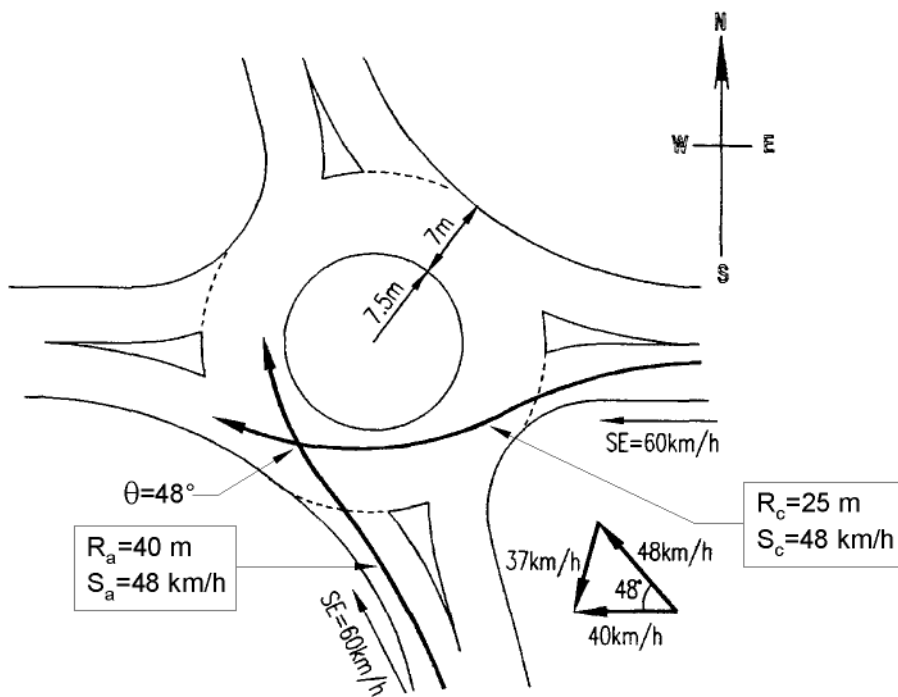

ADJACENT ROUNDABOUT APPROACHES  
WITH SUBSTANTIAL CURVATURE AND DEFLECTION

Figure 14.19 Single lane urban roundabout

#### 14.8.4 Potential relative speed of exiting and circulating vehicles

The exiting/circulating vehicle accident rate at any particular exit point of multi-lane roundabouts is predominantly related to the potential relative speed of exiting and circulating vehicles. Minimising the relative speed of exiting and circulating vehicles will minimise the exiting/circulating vehicle accident rate. The potential relative speed of exiting and circulating vehicles should be limited to 35km/h on multi-lane roundabouts.

Design principles 1, 3 and 6 given in Section 14.8.3 will usually reduce the potential relative speed between exiting and circulating vehicles.

#### 14.8.5 Difference in potential side friction

The sideswipe vehicle accident rate on multi-lane roundabouts is predominantly related to the difference in potential side friction. This difference is a measure of the degree that drivers will cut across adjacent lanes in order to minimise driver workload and speed reduction. It is related to the speed of vehicles staying in the correct lane and the speed of vehicles cutting lanes. The difference in potential side friction (calculated by Equation 14-10 in Appendix 14C) should be limited to 0.7 on multi-lane roundabouts.

### 14.9 Roundabout software program “ARNDT”

The computer program ARNDT (A Roundabout Numerical Design Tool) enables road designers to identify the likely safety performance of a new or existing

roundabout. This program is based on the results of a research program undertaken by Main Roads and documented by Arndt (1998) in his report titled “Relationship between Roundabout Geometry and Accident Rates”.

The program requires the user to input geometric, speed and traffic flow data for the roundabout to be analysed. The program calculates values of the accident parameters discussed in this section and identifies where they exceed the maximum set values. These are the primary identifiers of poor roundabout geometry. Using the results designers may then modify the geometry, and reanalyse it, to achieve better safety. A copy of this program can be downloaded from the internet at the following address:

[www.mainroads.qld.gov.au](http://www.mainroads.qld.gov.au)

Once at the website the user will need to navigate to the download by selecting the following:

- Inside Main Roads; then
- Corporate Areas; then
- Road System and Engineering; then
- Software; and finally
- ARNDT - A Roundabout Numerical Design Tool.

This program enables designers to form the basis of a good roundabout design. However, there are several other factors that can influence accident rates at roundabouts that are not considered by ARNDT. Designers need to consider such factors by referring to the relevant guidelines in this chapter.

Further details of ARNDT are given in:

- Appendix 14A which shows the various accident types used in this program.

- Appendix 14B which details the vehicle path and speed prediction models used in this program.
- Appendix 14C which lists the procedures used by the program to calculate the various accident rates and parameters at roundabouts.

### 14.10 Design of reverse approach curves

As discussed in Section 14.8.1, an excessive decrease in speed can occur at the start of entry curves in areas with high desired speeds. One method to limit this decrease in speed is to provide a number of reverse curves prior to the entry curve to limit the maximum decrease in speed between horizontal geometric elements to 20km/h. This treatment is usually required only in areas with high desired speeds (i.e. where the desired speed is greater than or equal to 80km/h). An example of this treatment is shown in Figure 14.20.

The upper diagram of Figure 14.20 shows a roundabout with the eastern approach leg in an area with a high desired speed. The decrease in speed at the start of the entry curve is 41km/h. This decrease in speed results in a potentially high single vehicle accident rate on the entry curve.

The lower diagram of Figure 14.20 shows the same roundabout approach consisting of two reverse approach curves to limit the maximum decrease in speed between successive elements to below 20km/h as recommended above. This geometry will reduce the single vehicle accident rate on the approach.

Other issues to consider when designing reverse approach curves include the following:

- The curves should be used in conjunction with reduced speed limits.
- The curves work best on single lane approaches but still perform well on two lane approaches. The appropriateness of these curves on approaches with more than two lanes is questionable.
- Their use is undesirable on downhill approaches (say greater than 3 percent slope).
- Each approach curve and the central island should be visible to drivers from before the first approach curve. The approach alignment should not disguise the fact that it is an entry to a roundabout.
- Superelevation (of 2.5% to 3%) should be provided on each of the curves.
- Use of short horizontal straights between each curve is desirable to obtain the required superelevation on each curve, to reduce sudden steering movements and to provide more time for drivers to react to each successive curve. Typically, this situation is covered by Cases 3B, 4A and 4B given in the reverse curves section of Chapter 11 of this manual. On rare occasions, Case 6 may apply.
- In constrained situations where it is not possible to incorporate short horizontal straights, superelevation development is covered by Cases 3A or 3B given in the reverse curves section of Chapter 11 of this manual.

14

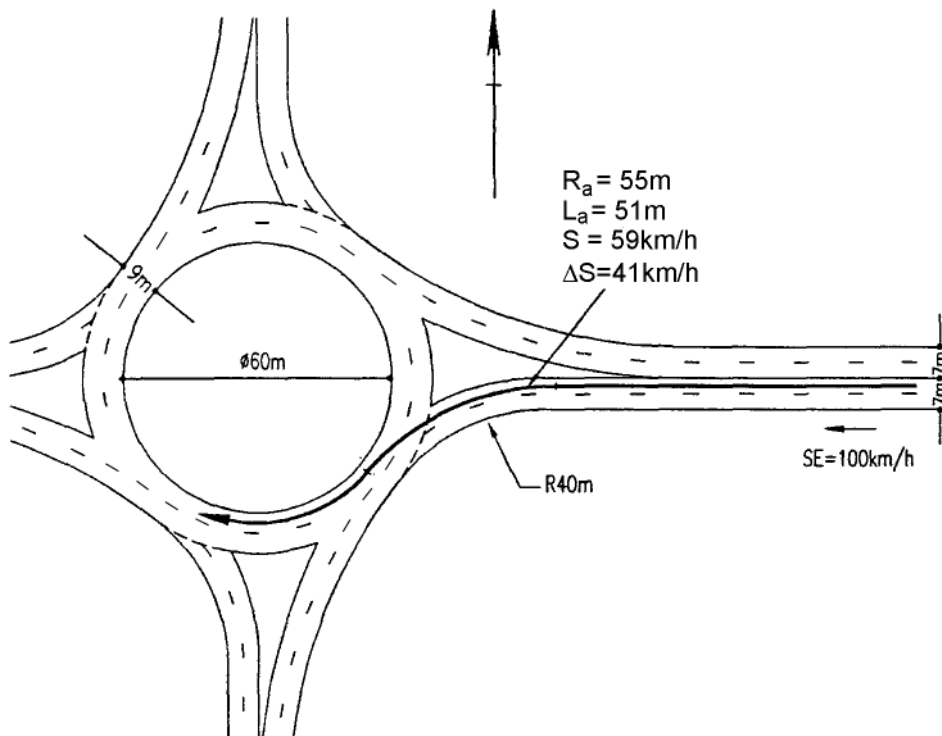

**ROUNDBOUT APPROACH CONSISTING OF A SINGLE ENTRY CURVE  
(DECREASE IN SPEED ON ENTRY CURVE = 41km/h)**

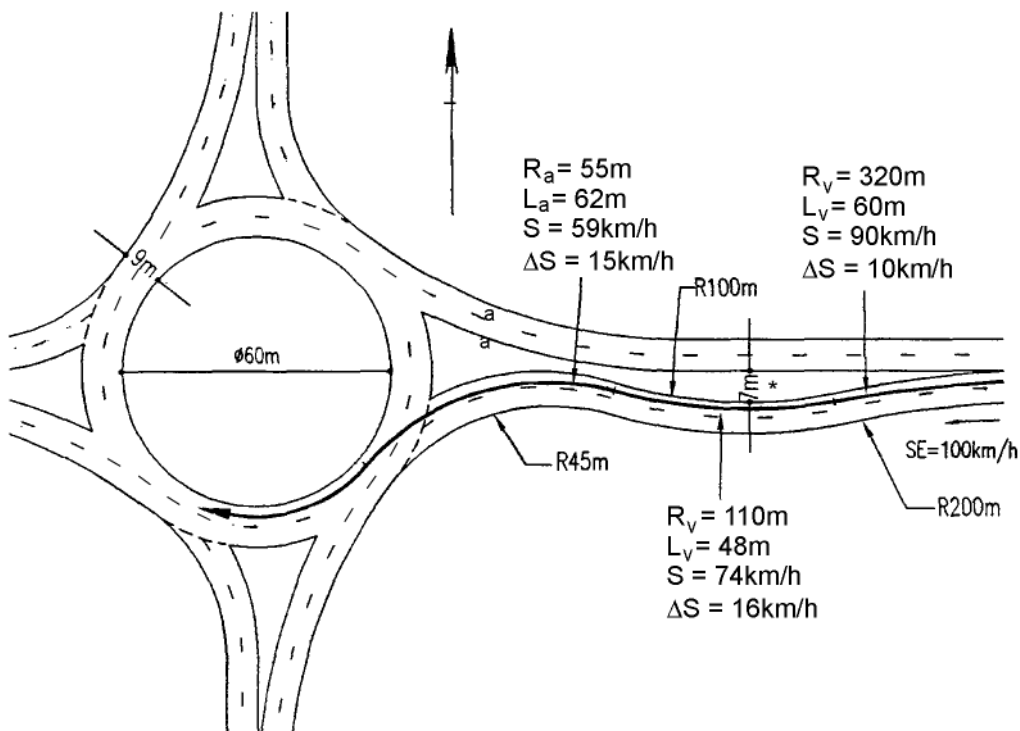

**ROUNDBOUT APPROACH CONSISTING OF AN ENTRY CURVE AND  
TWO REVERSE APPROACH CURVES  
(DECREASE IN SPEED BETWEEN SUCCESSIVE CURVES LIMITED TO 20km/h)**

Figure 14.20 Roundabout in a rural environment

The design of approaches to roundabouts on rural roads is more critical than for roundabout approaches in urban areas. This is because drivers travelling on rural roads for long distances for long periods of time are less alert. This concept has been discussed in Chapter 6 of this manual. It is especially important to consider the design criteria above for approaches on rural roads.

### **Length of reverse approach curves**

The length of each reverse approach curve should be kept as short as possible so that single vehicle accident rates are minimised. However, the curves must also be long enough to discourage most drivers from cutting across lanes. Shifting the approach roadway laterally by the width of the traffic lane/s (7m for the example shown in Figure 14.20) usually meets this criterion.

## **14.11 Separation between legs**

The design of corner kerb radii smaller than the entry curve or exit curve radii should be avoided where possible. Generally sharp corner kerb radii should never be used. Use of a sharp corner kerb radius results in minimum separation between an approach leg and the next departure leg. This produces a higher angle between the entering and circulating vehicle paths which increases the relative speed of entering and circulating vehicles. This in turn increases entering/circulating vehicle accident rates. For this reason, it is preferable to design the entry and exit curves tangential to the outer edge of the circulating carriageway as shown in Figure 14.18.

Maximising the width of the kerbed splitter islands maximises the distance between approach and departure carriageways of a particular roundabout leg. This maximises

the time for motorists to determine if circulating vehicles are turning left or continuing to circulate, thus minimising the entering/circulating vehicle accident rate.

The combination of avoiding the design of sharp corner kerb radii (that are substantially smaller than the approach or departure curve) and maximising the width of kerbed splitter islands increases the separation between legs and minimises the entering/circulating vehicle accident rate.

## **14.12 Central and splitter islands**

### **14.12.1 Central island**

#### **Central island shape**

Central islands should preferably be circular as continually changing curvature of the circulating carriageway increases driver workload. However, oblong or other shapes may need to be adopted to suit unusual site conditions.

Roundabouts with raised central islands give good driver recognition of the central island. Conversely, depressed central islands give poor driver recognition of the central island. For this reason, central islands of roundabouts should be raised wherever possible. Where raised central islands are provided on flat terrain, a central island height of 0.6m will usually suffice, although on very large roundabouts it can be higher. This height is measured from the highest edge of the circulating carriageway to the top of the central island. On small roundabouts (i.e. with a central island diameter less than say 20m to 25m) a raised central island may not be possible due to visibility constraints. In this case, mounding the roundabout to a height of 0.2m (measured as described above) and turfing is usually still possible. Figure

14.21 illustrates these central island treatments.

### Landscaping within central island

Landscaping within the central island will need to be kept outside the sight triangles as given in Section 14.13 unless low growth vegetation is provided. The maximum mature height of this vegetation must be below the sight lines calculated in Section 14.13. The current and likely future maintenance regime must also be considered. Vegetation within the central island should preferably contrast with vegetation on the outside of the roundabout

to help increase driver recognition of the central island.

Trees, planter boxes, feature walls etc should not be placed within the required clear zone from the circulating carriageway (refer Section 14.15). Large trees should not be planted in central islands regardless of the available clear zone. These can become a problem if the facility is upgraded in future years and may cause problems in lighting of the roundabout.

14

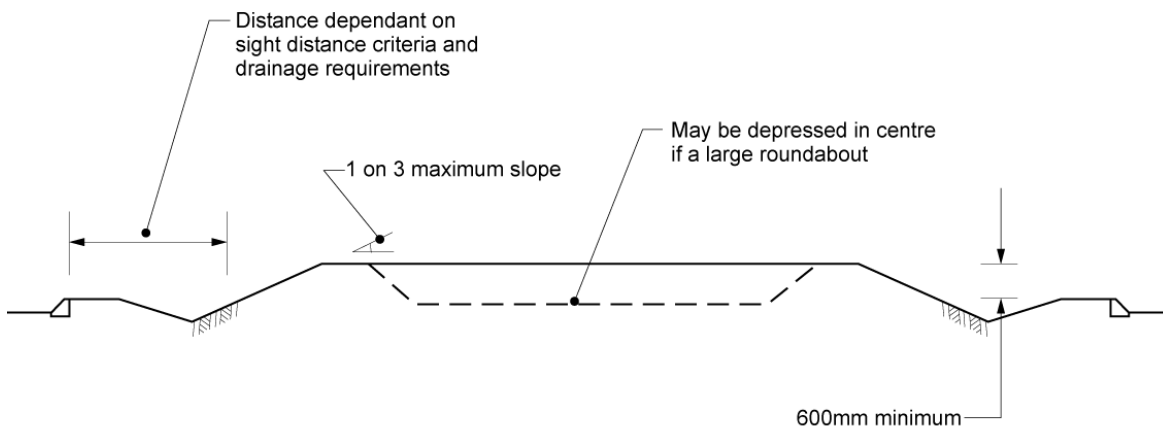

**GENERAL TREATMENT OF CENTRAL ISLAND ON LARGER ROUNDABOUTS  
(greater than 20-25m central island diameter)**

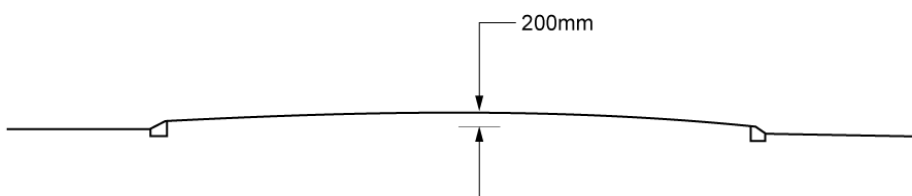

**GENERAL TREATMENT OF CENTRAL ISLAND ON SMALLER ROUNDABOUTS  
(less than 20-25m central island diameter)**

**Figure 14.21 Treatment for the central islands of roundabouts**



When landscaping on central islands is watered, care should be taken to prevent excess water or spray flowing onto the circulating carriageway. Only a drip irrigation system should be used. Drivers use high values of side friction on the circulating carriageway. Excess water on the carriageway decreases the amount of side friction available and substantially increases the chance of single vehicle accidents.

### Recognition of the roundabout

All central islands should be kerbed to enhance the prominence of the roundabout. The kerbing should be light coloured or painted white. To further improve driver recognition, reflectorised pavers in a chevron pattern may be placed on the central island.

The approach alignment should not disguise the fact that it is an entry to a roundabout and this will be reinforced if the drivers can see the circulating carriageway, the central island and the general shape of the roundabout.

#### 14.12.2 Splitter islands

Kerbed splitter islands should be provided on all approaches as they:

- provide shelter for pedestrians, assist in controlling entry speed;
- guide traffic onto the roundabout; and
- deter right-turners from taking dangerous “wrong way” short cut movements through the roundabout (as illustrated in Figure 14.22).

Splitter island kerbing should be light coloured or painted white. Splitter islands should be designed to direct vehicles onto the roundabout so that the vehicle path is

smooth but at an angle which affords the drivers comfortable sighting of (i.e. a good observation angle to) approaching traffic. The right hand edge of the entry curve, where it turns into the circulating carriageway, should be tangential to the central island as shown in Figure 14.17. However, in some cases the projection of the right hand edge of the entry curve may be permitted to cut slightly into the central island.

On urban arterial road roundabouts, the kerbed splitter island should be of sufficient size to shelter a pedestrian (at least 2.4m wide) and be highly visible to approaching traffic. A minimum area of 8m<sup>2</sup> to 10m<sup>2</sup> should be provided on any arterial road approach.

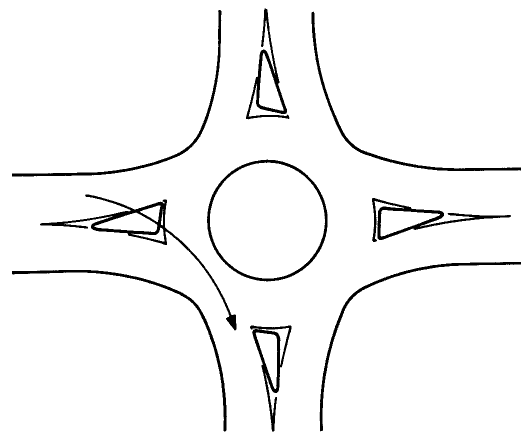

**Figure 14.22 Use of splitter islands to discourage hazardous wrong way movements**

On roundabout approaches from local roads, the general minimum area of kerbed splitter island is 5m<sup>2</sup> to 8m<sup>2</sup>. In extremely constrained cases, it may not be possible to obtain this. In these cases, it is preferable to provide a kerbed splitter island smaller than the general minimum rather than provide no island at all.

In high speed areas the splitter island should also be relatively long (ideally at least 60m) to give early warning to drivers that they are approaching an intersection and must slow down. Preferably the splitter island and its approach pavement markings should extend back to a point where drivers would be expected to start to reduce their speed. The lateral restriction and funnelling provided by the splitter island encourages speed reduction as vehicles approach the entry point. Kerb and channel should be placed on the left-hand side of the approach road for the length of the splitter island to strengthen the funnelling effect.

The length of the right hand edge of the entry curve should be sufficient for drivers to recognise easily the degree of curvature ahead. This is particularly so on divided roads and where vehicle approach speeds are high.

Landscaping and road furniture within splitter islands and medians should comply with the visibility and clear zone principles given for central islands in Section 14.12.1.

### 14.13 Sight distance

Three sight distance criteria must be applied to the combination of vertical and horizontal geometrics at roundabouts as illustrated in Figure 14.23 and discussed below. These criteria affect the positioning of signs, landscaping, poles and other roadside furniture.

It is important to note that:

- Criterion 1 and 2 are both mandatory requirements;
- Criterion 3 is a desirable requirement (i.e. it is not mandatory). However, written approval is required if it is not provided.

Within the sight triangles/zones subject to Criteria 2 and 3, it is acceptable to allow momentary sight line obstructions such as poles, sign posts and narrow tree trunks.

#### 14.13.1 Criterion 1

The alignment on the approach should be such that the driver has a good view of both the splitter island, the central island and desirably the circulating carriageway. Adequate Approach Sight Distance (ASD) should be provided to the holding line/s. Where this can't be achieved and, as an absolute minimum, ASD to the (approach) nose of the splitter island should be provided.

Table 14.6 indicates the required minimum stopping distances. Table 14.6 is based on Chapter 13 of this manual. The required ASD is based on the speed of drivers on the geometric element prior to the entry curve. If no approach curves exist (i.e. there is just a single entry curve), this speed will be equal to the desired speed of the particular approach leg. In any case, it is completely acceptable to use the desired speed.

**Table 14.6 Approach Sight Distance Criteria**

*Speed (km/h)	#Stopping Distance (m)
40	30
50	40
60	60
70	70
80	105
90	130
100	160
110	190
120	230
*On the geometric element prior to the entry curve. #Measured from a passenger car eye height of 1.15m to an object cut-off height of 0m.	

### 14.13.2 Criterion 2

A driver, stationary at the holding line, should have a clear line of sight (using a passenger car eye height of 1.15m) to traffic on any previous approach (an object height of 1.15m = passenger car eye height). The desirable minimum length of this line of sight is based on the distance travelled in 4 seconds (observation time plus reaction time) at the 85<sup>th</sup> percentile speed plus the stopping distance (measured along vehicle paths from previous approaches). The absolute minimum length of this line of sight is based on the distance travelled in 2.5 seconds (observation time plus reaction time) at the 85<sup>th</sup> percentile speed plus the stopping distance. Written approval must be obtained in order to use sight distance standards below the desirable minimum (e.g. to use the absolute minimum).

The distance calculated is measured from the conflict point along each vehicle's travel path as shown in Figure 14.23. The vehicle path can be calculated using the procedure in Appendix 14B (assume vehicles travel in the right lane for multi-lane roundabouts). If vehicle paths are not calculated, it is acceptable to measure this distance from 5m behind the holding line directly to the previous approach.

This criterion is similar to the concepts behind Safe Intersection Sight Distance (SISD) for at-grade intersections (refer to Chapter 13 of this manual).

#### Approach immediately to the right

For an approach immediately to the right, Criterion 2 sight distance should be based on the 85<sup>th</sup> percentile speed on the previous approach leg calculated by using the ARNDT program (recommended) or the method described in Appendix 14B. In

slow speed urban areas with tight geometry, this speed could be as low as 35km/h. Conversely, for large diameter roundabouts in high speed areas comprising inadequate entry curvature, this speed may be as high as 80km/h. If the designer is unable to calculate this speed, it is completely acceptable to use the desired speed of the previous approach leg. Table 14.7 shows the Criterion 2 sight distances required for the various 85<sup>th</sup> percentile speeds.

#### “Other” approaches

The Criterion 2 sight distance should also be checked in respect to vehicles on the circulating carriageway having entered from “other” approaches (i.e. approaches other than the approach immediately to the right). The speed of these vehicles should be based on the 85<sup>th</sup> percentile speed on the circulating carriageway calculated by using the ARNDT program (recommended) or the method described in Appendix 14B. These speeds may range from 25km/h for small urban roundabouts to 60km/h for large rural roundabouts. Table 14.8 shows Criterion 2 sight distances required for “other” approaches based on the radius of the central island.

**Table 14.7 Criterion 2 sight distances**

85 <sup>th</sup> Percentile Speed (km/h)	Criterion 2 Sight Distance (m)	
	Absolute Minimum - 2.5s Observation & Reaction Time	Desirable Minimum - 4s Observation & Reaction Time
20	17	25
30	28	40
40	40	57
50	54	74
60	71	96
70	91	121
80	114	147

14

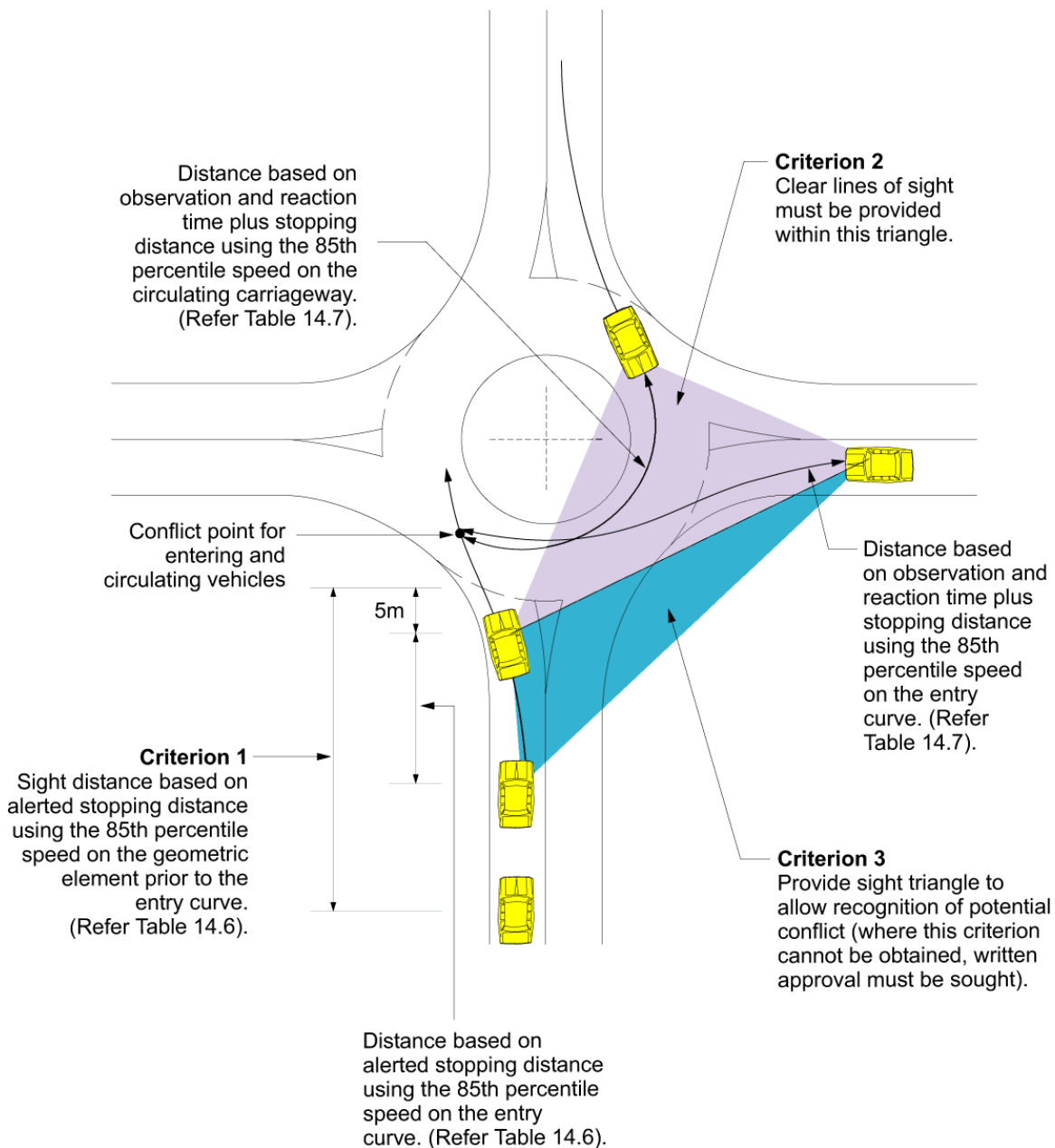

Figure 14.23 Sight distance criteria for roundabouts

**Table 14.8 Criterion 2 sight distance for “other” approaches**

Central Island Radius (m)	85 <sup>th</sup> %ile Speed (km/h)	Criterion 2 Sight Distance (m)	
		Absolute Minimum - 2.5s Observation & Reaction Time	Desirable Minimum - 4s Observation & Reaction Time
5	20	17	25
6	22	19	28
8	25	22	32
10	27	24	36
12	29	27	39
14	31	29	42
16	33	32	45
18	35	33	49
20	37	36	51
23	39	39	56
26	42	42	60
30	45	46	65
35	48	51	71
40	51	56	77
45	54	61	84
50	57	66	90
60	*62	75	101

\*Circulating carriageway speeds greater than 60km/h are generally not applicable if good entry curvature is provided.

### 14.13.3 Criterion 3

A driver approaching a roundabout should be provided with adequate sight distance to see other vehicles on any previous approach well before that driver reaches the holding line. The Criterion 3 sight triangle shown in Figure 14.23 allows an approaching driver (using a passenger car eye height of 1.15m) time to stop and avoid a vehicle driving through the roundabout (an object height of 1.15m = passenger car eye height) at the 85<sup>th</sup> percentile speed calculated for Criterion 2. The design speed of the approaching driver is based on the 85<sup>th</sup> percentile speed on the entry curve calculated by using the ARNDT program (recommended) or the method described in Appendix 14B (assume vehicles travel in the right lane for multi-lane roundabouts).

Table 14.6 shows the stopping distances required for the various 85<sup>th</sup> percentile speeds.

In some cases (particularly urban areas), it may not always be possible to obtain Criterion 3 sight distance. Where it is uneconomical or impractical to obtain this criterion, the maximum amount of sight distance possible should be provided. In this case, adoption of sight distance standards less than Criterion 3 must have written approval.

### 14.13.4 Other visibility considerations

At any roundabout, designers must provide the sight distance quantified and described above. A driver must also be provided with sufficient visibility to readily assess the driving task. The sight distance required for this is not quantified precisely and only general guidance can be given.

The following observations are as relevant for roundabouts as for other types of intersections (also refer to Chapter 13 of this manual):

- It is better to position a roundabout/intersection in a sag rather on a crest;
- It is important to avoid placing a roundabout/intersection just over a crest where the layout is obscured from the view of approaching drivers.

At grade separated roundabouts, particularly where there may be a structure (e.g. pier) in the central island or a bridge railing which might obstruct a drivers' visibility, care must be taken to ensure that the sight distance requirements are met. Any safety barriers used to protect piers, structures, embankments, etc may also

interfere with visibility and must be located to avoid this interference.

## 14.14 Crossfalls and grades

### 14.14.1 Crossfall and grade of circulating carriageway

14

The crossfall of the circulating carriageway is a significant factor influencing single vehicle accidents for trucks. Adverse crossfall on the circulating carriageway results in higher single vehicle accidents for trucks than does superelevation on the circulating carriageway.

One negative aspect of using superelevation on the circulating roadway is that the circulating carriageway is sometimes hidden from the view of approaching motorists thereby inhibiting drivers' recognition of the central island (refer to Section 14.12.1).

However, the use of appropriate entry curvature in accordance with Section 14.7.1 will slow motorists before the roundabout so that the negative effects of both adverse crossfall and superelevation are minimised. Therefore, a relatively safe roundabout can be designed with either adverse crossfall or superelevation on the circulating carriageway. A crown following the centre line of the circulating carriageway may also be satisfactory.

Where superelevated circulating carriageways are used, water will drain from the circulating carriageway to the central islands. Drainage at the edge of the central island can be achieved by:

- The provision of regular breaks in the kerbing of the central island in conjunction with gently sloping sides (e.g. 1 on 10) on the outside of the

central island, open drains and gullies or culverts (refer to Figure 14.21).

- The provision of kerb inlets and underground storm water drainage.

As a general design practice, a maximum pavement crossfall or superelevation of 0.025m/m to 0.03m/m should be adopted for the circulating carriageway. A minimum crossfall or superelevation as low as 0.02m/m has been found to be adequate for pavement drainage provided construction tolerances are tightly controlled. A crossfall or superelevation of 0.02m/m would also provide additional driver comfort.

For roundabouts in slower speed areas where the terrain is relatively flat, adverse cross fall is usually provided on the circulating carriageway. For roundabouts on general sloping topography, there is benefit in choosing the crossfall to approximately match the slope across the whole of the roundabout. This can avoid the creation of sharp sag vertical curves on some of the approaches that would result from the use of continuous adverse crossfall on the circulating carriageway.

On circulating carriageways with varying crossfall/superelevation, the crossfall/superelevation should stay within the range of  $\pm 4\%$ . Grades on the circulating carriageway greater than 4% should be avoided. Where the general slope of the land is greater than 4%, it will be necessary to "bench" the area for the roundabout, using a desirable maximum grade of 3% with an absolute maximum grade of 4%.

### 14.14.2 Approach grade

Generally, a maximum grade of 6% should be applied along the length of the entry curve.

## 14.15 Clear zone and roadside hazards

Within the context of the low overall accident rates for roundabouts, single vehicle accident rates at roundabouts are high compared to other intersection types. This is because roundabouts consist of a number of relatively small radius horizontal curves for each travelled path through the roundabout. Drivers travel on these curves with quite high values of side friction, particularly in high speed areas. Single vehicle accidents, which predominantly involve out-of-control vehicles, increase as the required amount of side friction increases.

Because of the relatively high number of out-of-control vehicles, it is desirable to have adequate amounts of clear zone where there are no roadside hazards on each side of the carriageway. Roadside hazards common at roundabouts include light and power poles, large trees and sign supports. If roadside hazards cannot be located outside the required clear zone, consideration should be given to making them frangible. If it is not possible to remove roadside hazards or make them frangible, protecting them with safety barriers is necessary. However, safety barriers are a hazard in themselves and are the least desirable option. In addition, safety barriers in the vicinity of the holding line often obscure visibility to circulating vehicles. Central lighting is often preferred for this reason as well as for economy.

## 14.16 Pavement conditions

Drivers generally use high values of side friction on all geometric elements of a roundabout. This is particularly true in high speed areas and especially on the entry

curve and the circulating carriageway. To ensure that high values of side friction can be delivered by the pavement to minimise single vehicle accident rates, the pavement surfacing selected should possess high friction and skid resistance properties (e.g. asphalt or special high friction materials [the latter may be high maintenance however]) and should be maintained in good condition.

In addition the torque generated by the tyres of turning vehicles on the pavement surfacing can cause problems (e.g. stripping of aggregate from bitumen seals). For this reason asphalt pavement surfacing is recommended. This is particularly true for tighter curves/smaller roundabouts. The extent of asphalt surfacing also requires some thought (e.g. apply to circulating carriageway and the full length of each entry curve). Specialist advice on surfacings at roundabouts may be obtained from the Principal Engineer (Road Surfacings) of the Pavements, Materials and Geotechnical Division of Main Roads' Road System and Engineering Group.

## 14.17 Pedestrians

It is essential that splitter islands (or medians) are provided for pedestrians (refer Section 14.12.2)

In the planning and design of roundabouts special thought should be given to the movement of pedestrians. Evidence suggests that roundabouts are at least as safe for pedestrians as other forms of intersection control. This is possibly because pedestrians are able to cross one direction of traffic at a time by staging on the splitter islands. However, pedestrians must cross with care because, unlike traffic signals, roundabouts do not give priority to pedestrians over through traffic movements.

Exits are particularly hazardous. Particular groups of pedestrians, such as the elderly or children find traffic signals a more secure form of control for crossing a road.

Pedestrian delays at roundabouts can be expected to be similar to other forms of unsignalised intersection control and generally less than at signalised alternatives.

It is important not to give pedestrians a false sense of security by painting pedestrian crosswalk lines across the entrances and exits of roundabouts, but rather to encourage them to identify and accept gaps in traffic and to cross when it is safe to do so. Notwithstanding this, pram crossings in the kerb lines and adequate width for pedestrian refuges will generally be required. It is recommended that these pram crossings be provided generally about 1 to 2 car lengths (6m to 12 m) back from the holding line at the entrances of roundabouts. At the exits, 2 to 4 car lengths (12m to 24 m) is preferable.

However, at this point, vehicle speeds can be relatively high. As vehicle speed increases, the chance of a pedestrian accident is also increased because vehicles cannot stop as quickly. In addition, the severity of a pedestrian accident is increased as vehicle speed increases.

To minimise pedestrian accidents at crossings of entries and exits, the entry and exit speeds should be kept low. The best solution to achieve this is to provide small radius entry and exit curves. This will ensure that entering, circulating and exiting vehicle speeds are kept relatively low. Figure 14.18 shows a desirable roundabout treatment where pedestrian crossings are required (also refer to Sections 14.7 and 14.8.)

In areas where there are no pedestrians, a large radius exit curve is desirable to enable vehicles to leave the roundabout as quickly as possible (refer Section 14.7.)

Consideration may be given to providing priority crossings (e.g. zebra crossings), for pedestrians where:

- pedestrian volumes are high;
- there is a high proportion of young, elderly or infirm citizens wanting to cross the road; or
- pedestrians are experiencing particular difficulty in crossing and are being delayed excessively.

However, if these conditions apply a roundabout may not be the most appropriate intersection treatment and alternative treatments should be considered (refer to Chapter 13 of this manual).

If zebra crossings at roundabouts are chosen they should be located as described above. Again, to minimise pedestrian accidents at these locations, the entry and exit speeds should be kept low by providing small radius entry and exit curves.

The ability of vehicles to enter a roundabout can be severely affected by a zebra crossing. It decreases the rate vehicles can both enter and leave the roundabout and this must be considered in an analysis of capacity and delays at the roundabout.

In the more critical situations, the distance required between the exit from the roundabout and a pedestrian crossing may be determined from Figure 14.24. This gives the 95<sup>th</sup> percentile vehicle queue length of vehicles waiting while a pedestrian crosses an exit carriageway that is either 5m or 10m wide. The graph is based on the assumptions of low pedestrian



flow, a walking speed of 1.5m/s and that there is sufficient time available between pedestrian movements for queued vehicles to clear. If there is considerable pedestrian activity then the queue lengths will be longer and a signalised pedestrian crossing may be required.

A signalised pedestrian crossing near a roundabout may assist its operation by increasing the size of bunches enabling drivers to enter from side roads. (For further details refer to Section 3.9.4 of the GTEP - Part 6 - Roundabouts on Entry Metering [Austroads, 1993]). However it may also cause queuing into the circulating carriageway if used on an exit; a situation that should be avoided.

Pedestrian crossings, at the distances from the roundabout determined from Figure 14.24, may be designed and laid out in the same manner as any pedestrian crossing.

Other design considerations to enhance pedestrian safety at roundabouts include:

- designing splitter islands which are as large as the site allows;
- prohibiting parking on the approaches to the roundabouts to provide clear visibility;
- providing street lighting which illuminates not only the circulating carriageway but also the approaches; and
- locating signs and vegetation so as not to obscure “small” users of the road such as pedestrians.

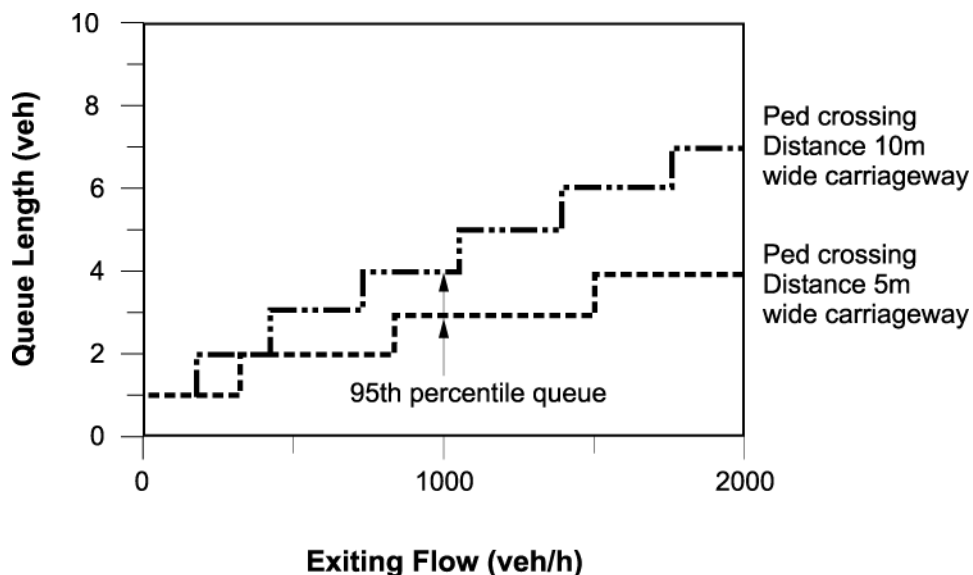

Figure 14.24 The queue length that will be exceeded 95% of the time for pedestrian crossing distances of 5m and 10m

It is emphasised that with most roundabouts, special crossing facilities will not be necessary. Generally, the installation of well designed splitter islands of sufficient size to hold and protect pedestrians, allowing them to cross only one direction of traffic at a time, will result in their being able to move more safely and freely around the intersection than was the case before the installation of the roundabout.

**However, where pedestrian volumes are high, serious consideration should be given to the use of an alternative intersection treatment. This is especially true where the pedestrian content consists of school children or the elderly.**

### 14.18 Cyclists

In most situations roundabouts can be designed to provide an acceptable level of safety for cyclists. However, the extent to which special geometric treatments and/or traffic control measures are needed to achieve an adequate level of safety will depend on:

- the daily vehicle traffic volume and the peak hour flows;
- the proportion of cyclists in the total traffic stream;
- the functional classification of the roads involved; and
- the overall traffic management strategies for the location.

A number of studies have shown that roundabouts increase the risk of accidents to cyclists and this fact needs to be taken into account when considering the adoption of a roundabout treatment at an intersection.

Cyclists are involved as circulating vehicles in approximately 13% of the

entering/circulating vehicle accidents in Queensland and are well over-represented in these accidents.

Reducing the relative speed between entering and circulating vehicles, minimising the number of circulating lanes, and maximising the distance between approaches reduces the entering/circulating vehicle accident rates at roundabouts. These design concepts will also minimise entering/circulating vehicle accidents involving cyclists. Therefore, the design concepts given in this chapter will also minimise accidents involving cyclists.

The results of various studies indicate that a separated cycle path, located outside of the circulating carriageway, is the safest design when there are high vehicle flows.

Separate cycle paths have been found to be safer than a bicycle lane within the road carriageway, particularly at highly trafficked roundabouts. This treatment has the added advantage of restricting widths through the roundabout enabling better entry curvature and deflection to be obtained.

Studies have also shown that the effect of the signalisation at roundabouts has resulted in an overall reduction in accidents involving cyclists.

The increased risk to cyclists needs to be seriously considered when “weighing up” the advantages and disadvantages of adopting a roundabout treatment at a particular location. The choice will often depend on the proportion of cyclists and other “non-motorised” road users expected to use the roundabout along with other factors such as the functional classification of the roads involved and the overall traffic management strategies to be adopted.

Specific provision is not generally required at single lane roundabouts where vehicle speeds through the roundabout are less than 50km/h.

Special provision for cyclists is desirable where:

- the cumulative, approach traffic volume, exceeds 10,000 vehicles per day;
- there is a multi-lane roundabouts; or
- vehicle speeds exceed 50km/h through the roundabout.

This can be achieved by:

- providing a path of access for cyclists separated from the road carriageway as shown in Figure 14.25 and detailed in Figure 14.26, as an alternative to the use of the road carriageway at the roundabout. In most instances, and particularly in the case of large roundabouts, it would be desirable for the path to be two-way, in order to provide cyclists with a convenient choice of route to the road carriageway, and hence encourage as many cyclists as possible to use the facility;
- using footpaths located adjacent to the roundabout where separate provision is not possible (illustrated in Figure 14.25 which shows a treatment whereby cyclists may move between the road and path via properly designed ramps. Fencing or landscaping between the path and carriageway, is necessary to prevent 'ride-out');
- providing traffic signals for one or all entries to a roundabout, depending on the predominant paths of cyclists and other traffic, or depending on the accident history;

- providing a controlled crossing on critical approaches of very large roundabouts on busy roads or grade separation where cyclist demand is very high.

Other situations where special consideration of cyclists is required to assist access and safety include:

- by-pass of three legged roundabouts for cyclists travelling straight through the intersection;
- where the skew of roundabout legs necessitates provision of a left turn slip lane on the corner of a roundabout; and
- where a major motor vehicle movement is able to by-pass the roundabout at speed.

In such cases designers should consider and evaluate other alternative treatments for the roundabout in order to provide suitable access for cyclists.

To ensure that potential conflicts between cyclists and pedestrians are addressed pedestrian movements must be considered where:

- it is proposed to construct separate perimeter paths around the outside of roundabouts; or
- shared use paths exist around roundabouts.

Where the perimeter path crosses a road, the exiting traffic creates a potential safety problem for cyclists and pedestrians (Figure 14.26 and Section 14.15). If a safety problem develops in these circumstances, consider installing a controlled crossing.

For further discussion on providing for cyclists, refer to the GTEP - Part 14 - Bicycles (Austroads, 1999).

14

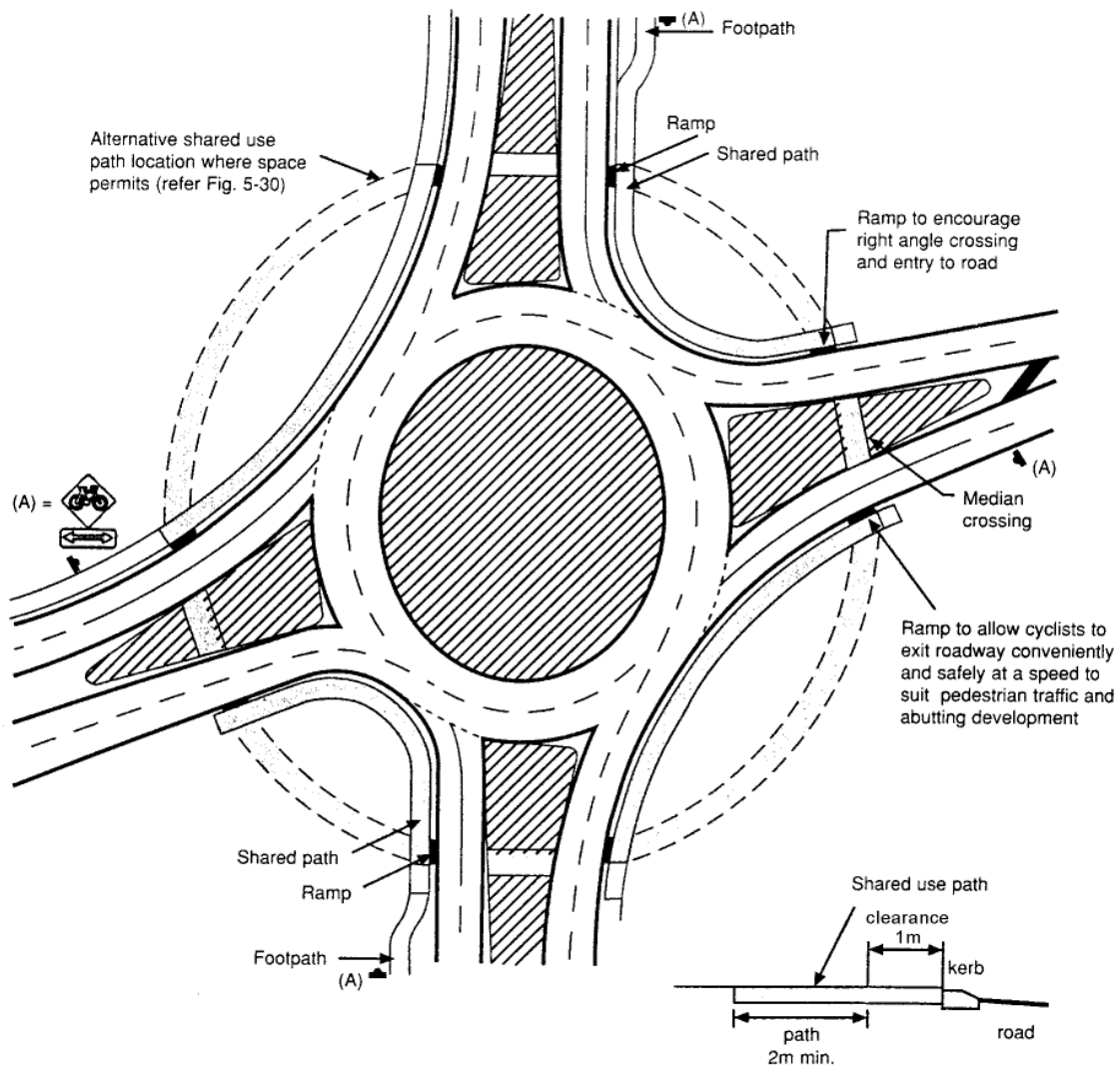

Figure 14.25 Paths for inexperienced riders at roundabouts

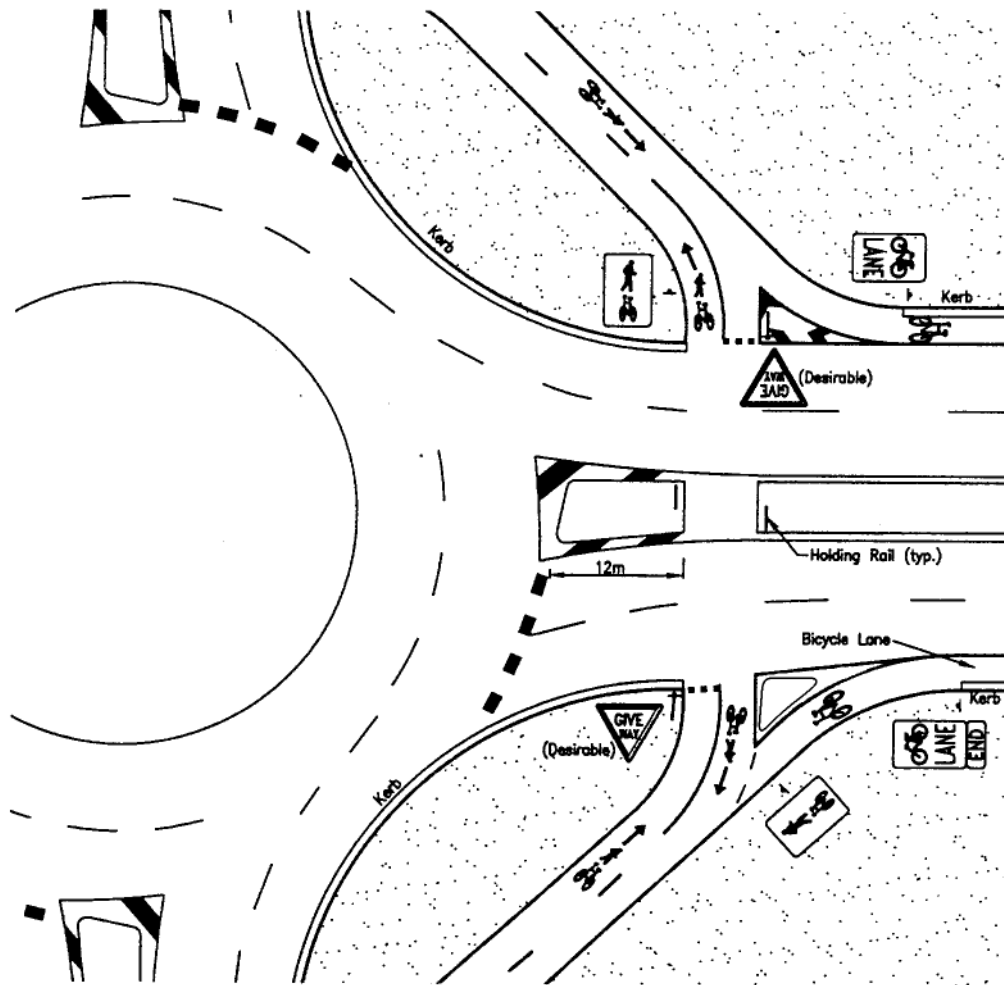

Figure 14.26 Separate perimeter path details for roundabouts

## 14.19 Special treatments

### 14.19.1 Wide medians and streets of unequal width

Particular problems in roundabout design occur at locations where one intersecting street is considerably wider than the other and/or where a wide median exists. This situation can occur with local, collector or arterial streets or, as is often the case, where the intersecting streets are not of the same functional classification. Very often a roundabout will not be the appropriate type of treatment in these cases. However, where the volume of traffic on the narrower street is greater than or equal to that on the wider street and if there are heavy right turn flows, a roundabout could be suitable.

Where a roundabout is proposed, special care should be taken to ensure that the design is in accordance with the guidelines given in this chapter. In particular, providing sufficient entry curvature and deflection for through traffic entering the roundabout is most important. Generally, a low cost solution that does not require road works encroaching onto existing nature strips and/or the median will not be possible.

Figure 14.27 is an example of a roundabout designed for an undivided road crossing a divided road with a wide median. In these situations the central island is not circular and as a result there will be different circulating speeds for different sections of the circulating carriageway. Right turning drivers entering from the narrow road in

Figure 14.27 will find that the radius of their turning path decreases and becomes more difficult (due to the compound curves). A circular roundabout at this location, although quite large, would provide a safer treatment and so is desirable, if space permits.

### 14.19.2 Wide undivided streets and “T” intersections

Where a roundabout is to be constructed at an existing “T” junction, it is generally necessary to build out the kerb line opposite the terminating road to provide deflection of the traffic movement across the top of the “T”. This practice has also been adopted at certain cross road intersections where one cross street is wider than the other and/or where there is space for more than one lane of traffic on a particular approach (refer Section 14.19.1).

Where kerb lines are to be built out on approaches to roundabouts, special care should be taken to ensure that adequate delineation is provided, particularly in instances where there are no parked vehicles on the approach. A suitable treatment using line marking, Retro-reflective Raised Pavement Markers (RRPMs) and semi-mountable kerbs is shown in Figure 14.28.

This layout has been devised with the objective of providing a safe, well delineated, but sufficiently deflected path through the roundabout, while limiting the amount of parking that has to be restricted.

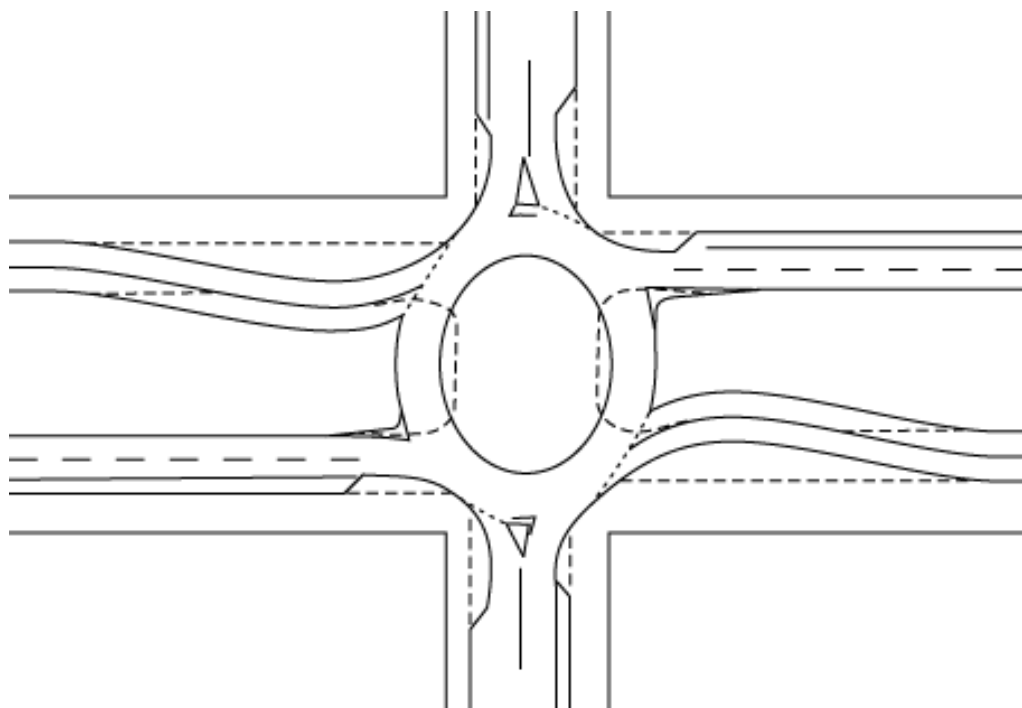

Figure 14.27 Roundabout on a road with a very wide median

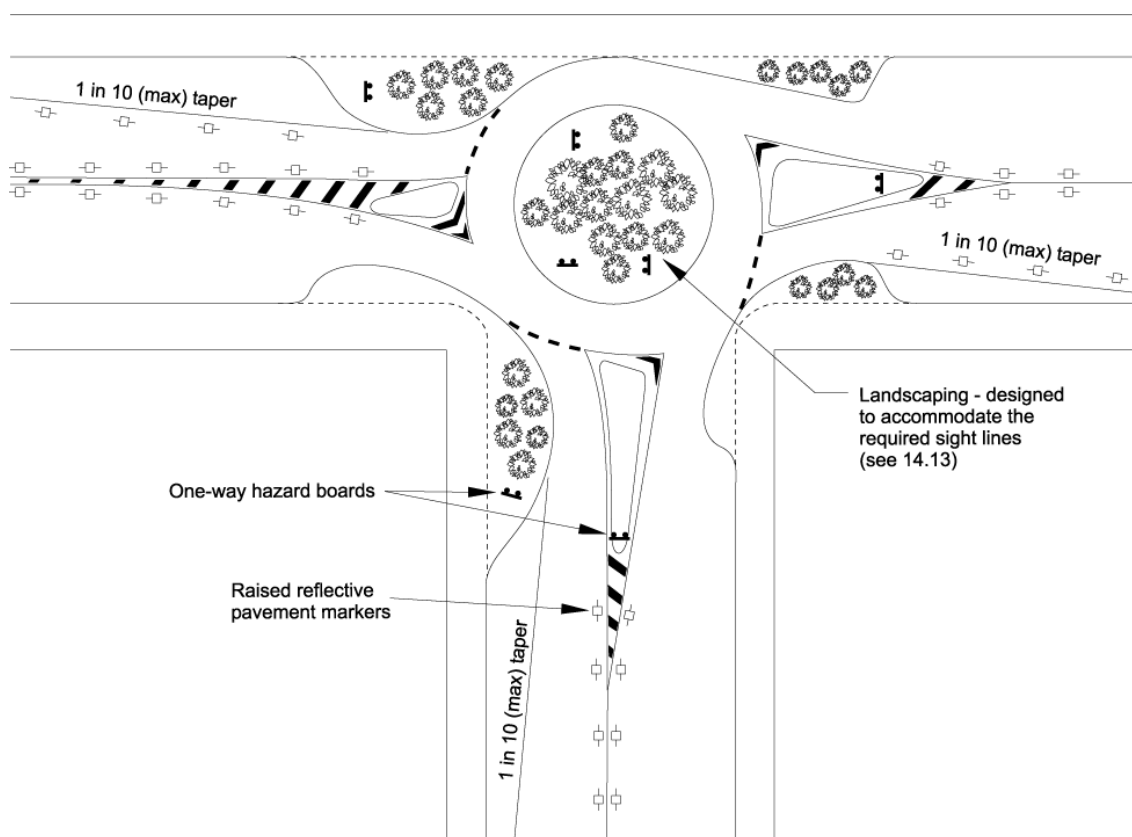

Figure 14.28 Roundabout at "T" intersections in an urban area

## References

Arndt, O. (1998), *Relationship Between Roundabout Geometry and Accident Rates - Final Report*, Report Number ETD02, Queensland Department of Main Roads, Brisbane.

Austrroads (1988), *Intersections at Grade*, Guide to Traffic Engineering Practice Part 5, Austrroads, Sydney.

Austrroads (1993), *Roundabouts*, Guide to Traffic Engineering Practice, Part 6, Austrroads, Sydney.

Austrroads (1999), *Bicycles*, Guide to Traffic Engineering Practice, Part 14, Austrroads, Sydney.

Office of the Queensland Parliamentary Council (1999), *Transport Operations (Road Use Management - Road Rules) Regulation*.

Queensland Department of Main Roads (2001), *Guide to Pavement Markings*, Queensland Department of Main Roads, Brisbane.

Queensland Department of Main Roads (2003), *Manual of Uniform Traffic Control Devices*, Queensland Department of Main Roads, Brisbane.

Queensland Department of Main Roads (2004), *Road Landscape Manual*, Queensland Department of Main Roads, Brisbane.

Queensland Department of Main Roads (2004), *Traffic and Road Use Management (TRUM) Manual*, Queensland Department of Main Roads, Brisbane.

## Relationship to other chapters

- Relies on information from Chapters 6, 7, 9 and 11.
- Chapter 5 provides basic traffic prediction and analysis information and it defines the dimensions of the various design (and check) vehicles.
- Chapter 5 also describes the particular requirements of various road users:
  - o Pedestrians;
  - o Cyclists;
  - o Road users with a disability; and
  - o Motorcyclists; plus
- Closely related to Chapter 13.



## Appendix 14A: Accident types

the total number of accidents into the various categories used in the study.

Figure 14.29 illustrates various geometric elements and various accident categories used in the Main Roads roundabout study Arndt (1998). Figure 14.30 breaks down

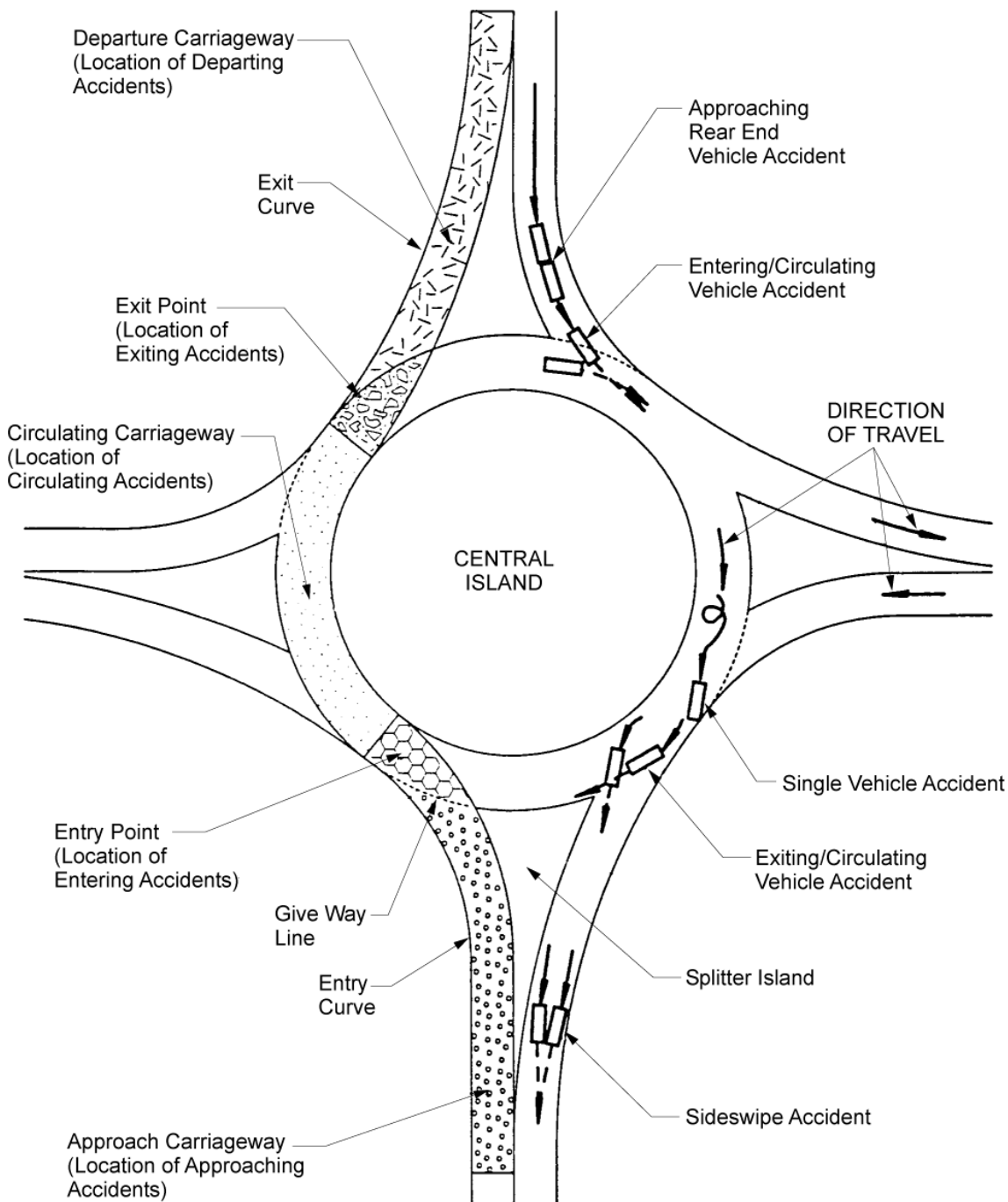

Figure 14.29 Geometric elements of a typical roundabout and typical accident types

14

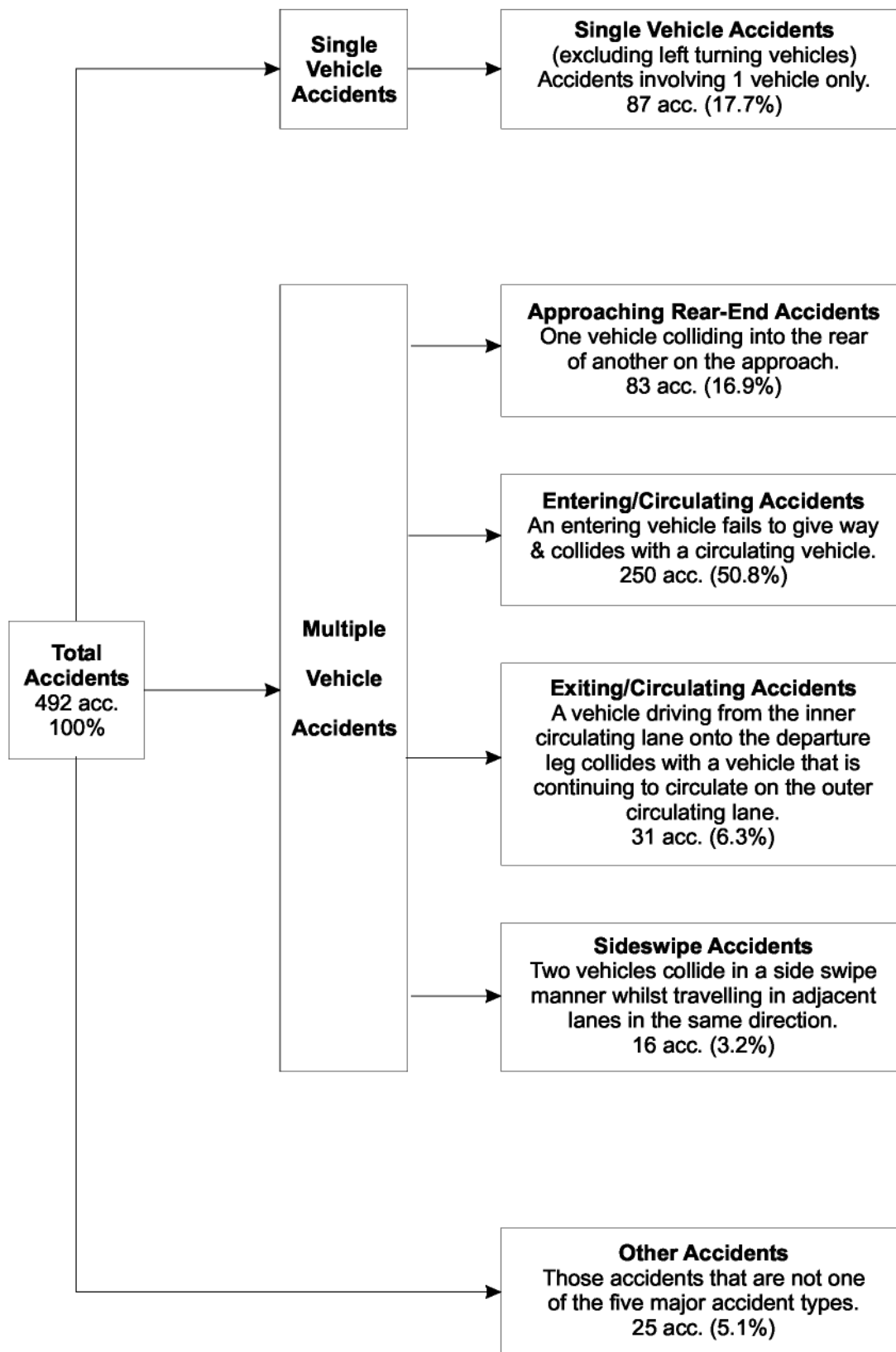

Figure 14.30 Accident categories

## Appendix 14B: Vehicle paths and speed prediction model

### Offsets to vehicle paths

At single lane roundabouts, drivers select their paths to obtain the largest possible radii (i.e. select their path to maximise their speed). It has been found that drivers typically travel to maintain the following distances between the edge of their vehicles and particular geometric features:

- 0.5m from a road centre-line;
- 0.5m from the face of concrete kerbing/kerb and channelling; and
- 0m from a painted edge line or chevron.

Assuming an average vehicle is 2m wide, the following distances from the centreline of the vehicle to the above geometric features result:

- a. 1.5m from a road centre-line;
- b. 1.5m from concrete kerbing; and
- c. 1m from a painted edge line or chevron.

### Vehicle paths through single lane roundabouts

The following steps will calculate vehicle paths through single lane roundabouts. This procedure applies to the construction of vehicle paths from any approach to any departure carriageway but excludes left turns. Construction of left turn paths is not required because accident rates for left turn vehicles are quite low.

1. Draw the vehicle path on the horizontal geometric element before the entry curve under consideration. This will be a line or curve parallel to the road centre-line, median edge or edge-line,

offset by the relevant distance (i.e. either a, b or c) given in the “Offsets to vehicle paths” Section above.

2. Draw the centre-line of the circulating lane under consideration.
3. Draw the entry path. This will be the largest curve that is tangent to both the lines or curves formed in Step 1 and Step 2 and that will meet the criteria of the distance from the centre of the vehicle to the geometric features given in the “Offsets to vehicle paths” Section above (i.e. either b or c).
4. Draw the vehicle path on the horizontal geometric element after the exit curve under consideration. This will be a line or curve parallel to the road centre-line, median edge or edge-line, offset by relevant distance given in the “Offsets to vehicle paths” Section above (i.e. either a, b or c).
5. Draw the exit path. This will be the largest curve that will be a tangent to both the lines or curves formed in Step 2 and Step 4 and that will meet the criteria of the distance from the centre of the vehicle to the geometric factors given in the “Offsets to vehicle paths” Section above (i.e. either b or c).
6. Draw the circulating path. This will be the largest curve that is a tangent to both the entry path and exit path drawn in Steps 3 and 5 and that will also meet the criteria of the distance from the centre of the vehicle to the geometric features given in the “Offsets to vehicle paths” Section above (i.e. either b or c).

A diagram of each step is shown in Figure 14.31.

### Vehicle path construction - additional considerations

When constructing vehicle paths the following issues should also be considered:

- If a curve cannot be drawn tangent to the centre-lines according to the criteria given in the “Vehicle paths through single lane roundabouts” Section for any step listed in the procedure, assume the vehicle path is straight and draw it as such.
- If the roundabout is elliptical, Step 2 will involve drawing a number of curves with different radii to form the centre-line of the circulating carriageway. If a single curve cannot be drawn between the approach and departure curves in Step 6, then assume the circulating path is the centre-line of the circulating lane as drawn.
- If approach curves exist prior to the entry curve, the following steps will determine vehicle paths on these curves:
  1. Draw the centre-line of the lane of the horizontal geometric element before the entry curve under consideration.
  2. Draw the centre-line of the circulating lane under consideration.
  3. Draw the entry path. This will be the largest curve that will be a tangent to both the lines or curves formed in Step 1 and Step 2 and that will meet the criteria of the distance from the centre of the vehicle to the geometric features given in the “Offsets to vehicle paths”(i.e. either b or c).
  4. Draw the vehicle path on the horizontal geometric element immediately before the approach curve. This will be a line or curve parallel to the road centre-line,

median edge or edge line offset by relevant distance (i.e. either a, b or c) given in the “Offsets to vehicle paths” Section.

5. Draw the vehicle path curve on the approach curve. This will be the largest curve that will be a tangent to both the curves drawn in Steps 3 and 4 above and that will meet the criteria given in the “Offsets to vehicle paths” Section (i.e. either b or c).
6. Repeat the above procedure to draw vehicle transition paths on any other approach curves.

A diagram of the construction of the vehicle path on an approach immediately before the entry curve is shown in Figure 14.58

### Vehicle paths through multi-lane roundabouts

Different vehicle path construction techniques are required for the various accident types at multi-lane roundabouts as detailed in Table 14.9.

**Table 14.9 Vehicle path construction methods for the various accident types for multi-lane roundabouts**

Accident Type	Vehicle Path Construction Method Adopted
Single vehicle	Vehicles remain in correct lane - use right hand lane
Approaching rear-end	Vehicles remain in correct lane - use right hand lane
Entering/circulating	Vehicles remain in correct lane - use right hand lane
Exiting/circulating	Vehicles remain in correct lane - use inner and outer lanes
Sideswipe	Vehicles both remain in correct lane (use right lane) and cut lanes

### Vehicles cutting lanes on multi-lane roundabouts

To construct vehicle paths based on vehicles cutting lanes, treat the roundabout, and its approach and departure legs, as a single lane roundabout by ignoring any lane lines between lanes travelling in the same direction. Then apply the same procedure as given in above for construction of vehicle paths through single lane roundabouts.

### Vehicles remaining in correct lane on multi-lane roundabouts

The procedure for the construction of vehicle paths based on vehicles remaining in their correct lane is the same as that given in the “Vehicle paths through single lane roundabouts” Section for vehicle paths through single lane roundabouts but is applied to a particular lane. A diagram of vehicle path construction in the right lane of a multi-lane roundabout is shown in Figure 14.33.

The same technique is used to find vehicle paths in the left lane. This procedure applies to the construction of vehicle paths from any approach to any departure leg but excludes left turns.

### Speed prediction model

The 85<sup>th</sup> percentile speed on any particular vehicle path segment is calculated using the graph in Figure 14.34. To calculate the speed on a curve, plot the radius of the vehicle path segment on the horizontal axis and project vertically until it meets the desired speed of the leg from which the vehicle came. From this point, project horizontally to the vertical axis and read off the 85<sup>th</sup> percentile speed of the curve.

The desired speed of a particular approach carriageway is the value used to calculate the 85<sup>th</sup> percentile speed on all vehicle path segments through the roundabout from this approach. This assumes that the desired speed does not change through the roundabout.

No acceleration is assumed between successive vehicle path segments in this model. Therefore, the speed calculated on any particular segment cannot be higher than the speed calculated on any particular preceding element. Figure 14.35 shows an example of calculating 85<sup>th</sup> percentile speeds by this method.

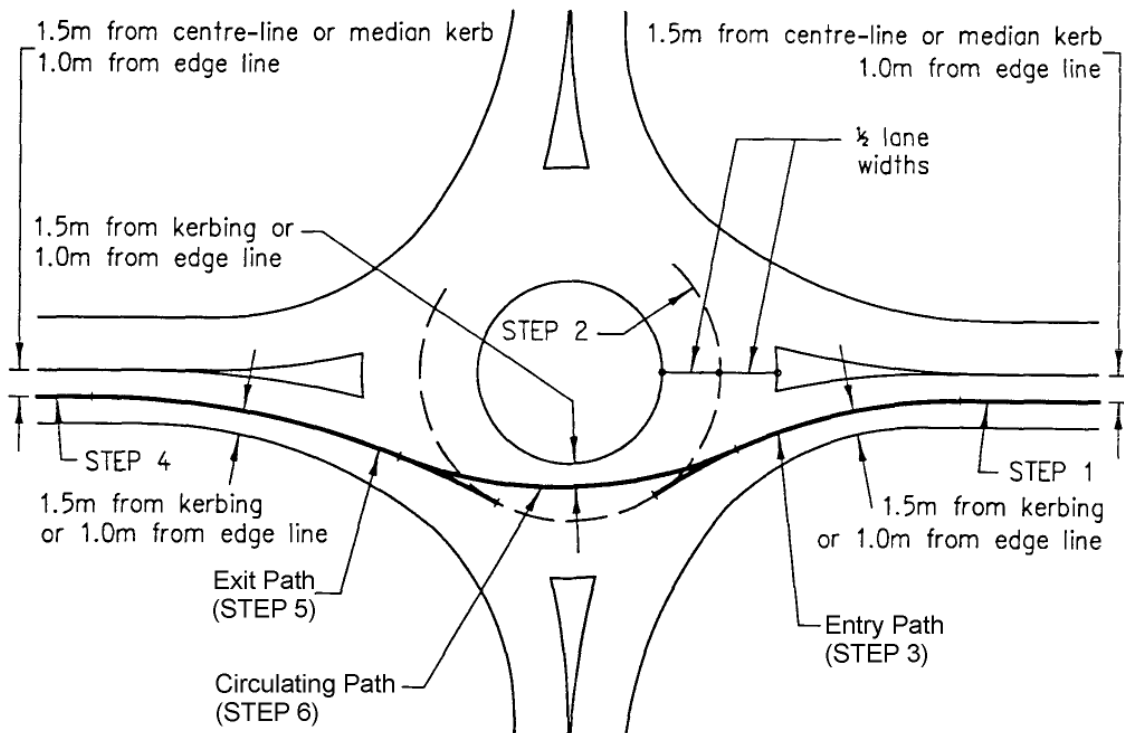

Figure 14.31 Vehicle path construction through roundabouts

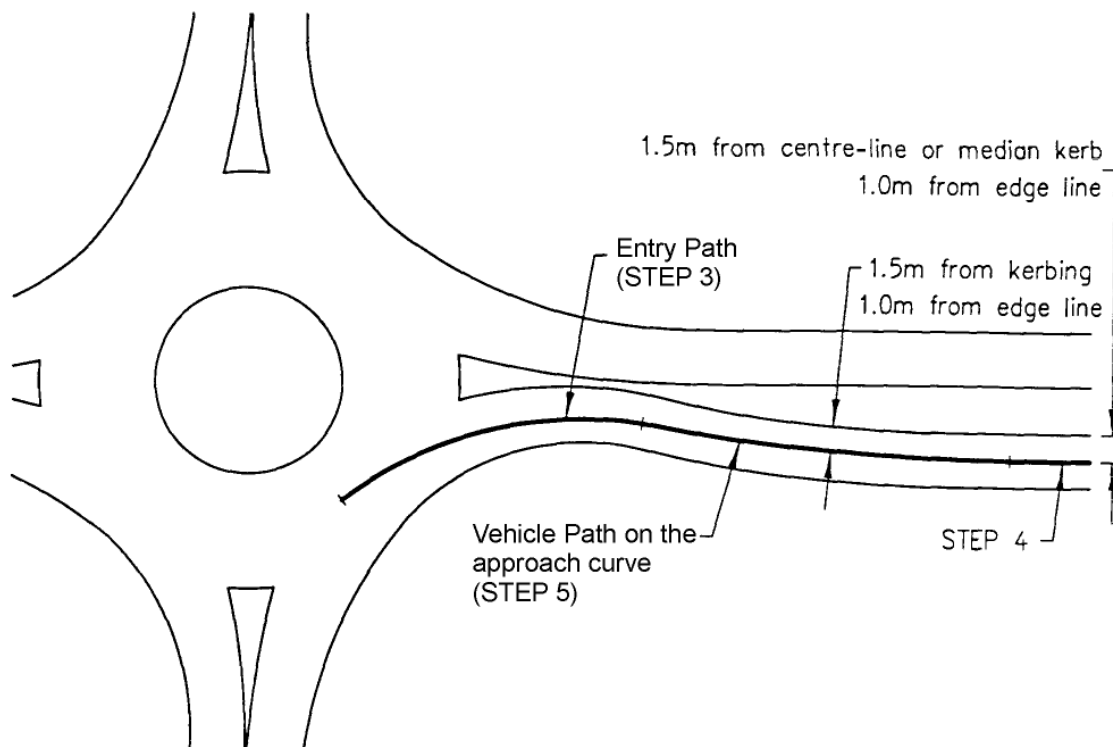

Figure 14.32 Construction of a vehicle path on an approach curve

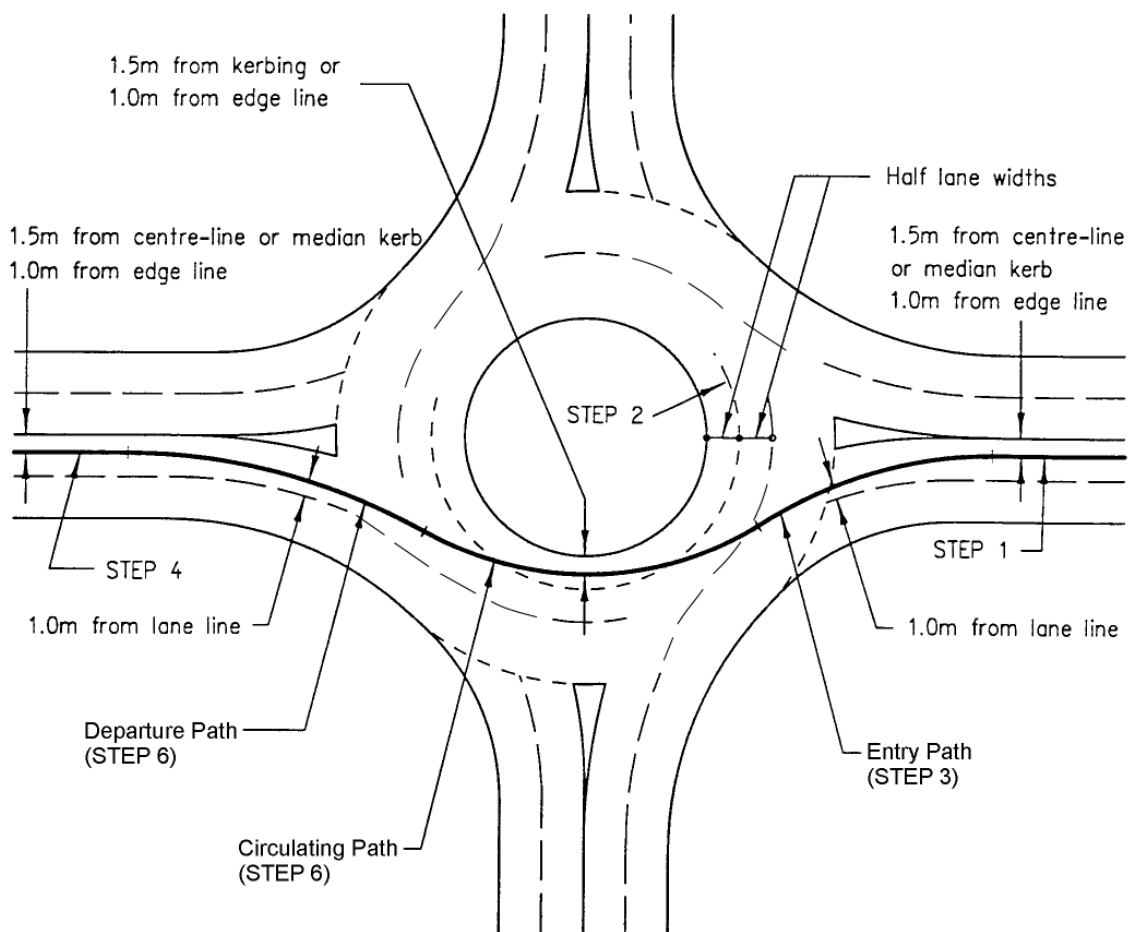
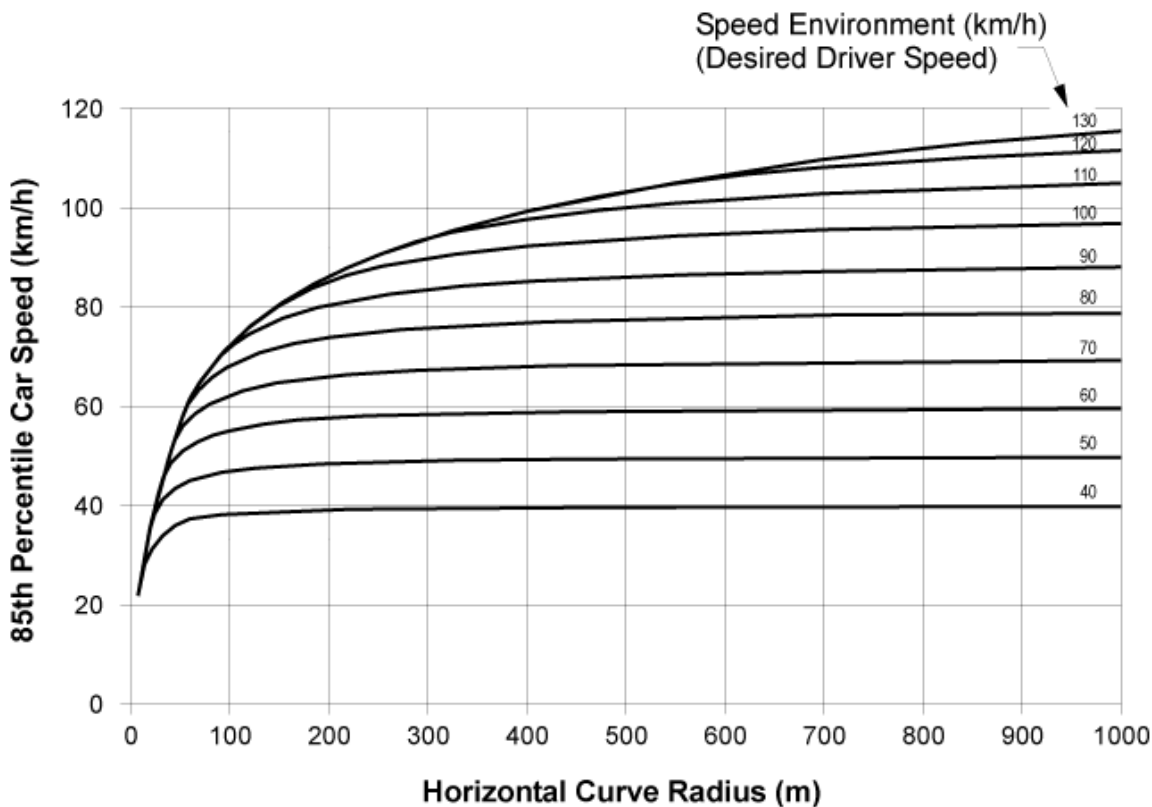
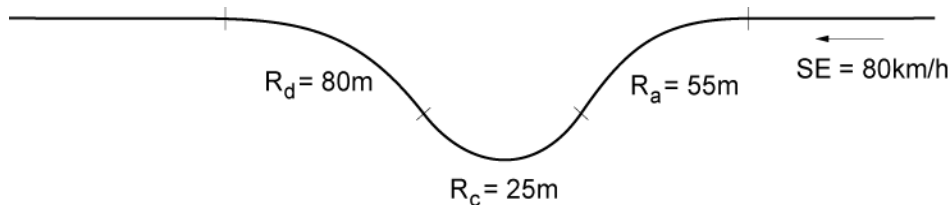

Figure 14.33 Vehicle path construction for the right lane of multi-lane roundabouts – through movement depicted



When using this figure, assume no acceleration between horizontal geometric elements

Figure 14.34 85<sup>th</sup> percentile passenger car speed versus horizontal curve radius



This diagram shows the vehicle path segments through a roundabout from a leg with an 80km/h desired speed. Calculation of speeds for the various segments is given below:

**Segment  $R_a$  (radius of the vehicle path on the entry curve)**

Using Figure 14.34, for a vehicle path radius of 55m with a desired speed of 80km/h, the 85<sup>th</sup> percentile speed on the entry curve is approximately 59km/h.

**Segment  $R_c$  (radius of the vehicle path on the circulating carriageway)**

Using Figure 14.34, for a vehicle path radius of 25m with a desired speed of 80km/h, the 85<sup>th</sup> percentile speed on the circulating carriageway is approximately 40km/h.

**Segment  $R_d$  (radius of the vehicle path on the exit curve)**

Because no acceleration is assumed in this model, and because  $R_d$  is greater than  $R_c$ , the 85<sup>th</sup> percentile speed on  $R_d$  (the exit curve) is made equal to  $R_c$  which is 40km/h.

Figure 14.35 Example calculation of 85<sup>th</sup> percentile speeds of passenger cars



## Appendix 14C: Procedure to calculate accident rates at roundabouts

This appendix shows the process of calculating accident rates at roundabouts used in the computer program ARNDT 'A Roundabout Numerical Design Tool'. ARNDT uses the accident models developed for the five major accident types and the "other" category shown in Figure 14.29 of Appendix 14A.

It is recommended that designers do not manually calculate accident rates using the process given in this section, due the complexity of the calculations.

### Inputs

The inputs required to determine accident rates at roundabouts are:

1. The layout of the roundabout including all approach geometry;
2. The desired speed of each leg; and
3. The traffic volumes for all movements.

### Procedure

The procedure to calculate accident rates at roundabouts is given below. The calculation of accident rates for the major accident types is undertaken on a leg specific basis. An example of this is applied to the southern leg of the roundabout shown in Figure 14.36.

#### Calculation A - Calculation of single vehicle accident rates at roundabouts

To calculate the single vehicle accident rates at a roundabout:

1. Identify all possible movements from the approach leg to be analysed ignoring left turns. Left turns can be identified by applying the vehicle path

method described in Appendix 14B for vehicles remaining in the right lane. If this method does not give a solution when applied to a particular movement, treat the movement as a left turn and do not use it in the calculations.

2. Determine vehicle paths from Appendix 14B for all of the movements identified in Step 1 of Calculation A for vehicles remaining in the right lane. Label each segment of the vehicle paths according to the coding system shown in Figure 14.37.
3. Measure the radius 'R' of each segment of the vehicle path.
4. Measure the length 'L' of each segment of the vehicle path.
5. Determine the 85<sup>th</sup> percentile speed 'S' on each segment using the speed prediction model described in Appendix 14B by assuming no acceleration between each segment.
6. Calculate the decrease in speed ' $\Delta S$ ' at the start of each segment. Identify segments with a value of  $\Delta S$  greater than 20km/h. These segments should be reviewed with the intent of improving the geometry (i.e. reducing  $\Delta S$  to a value that is equal to, or below 20km/h, except as described below). For a right turn movement on horizontal geometric elements of the circulating carriageway where the speed on the geometric element before the one under consideration is less than 60km/h, a maximum value of 30km/h for  $\Delta S$  is applicable. If the value of  $\Delta S$  is exceeded on the entry curve, reverse curves on the approach can be introduced, or a combination of the treatments listed in Section 14.8.1 can be used prior to the entry curve. If

14

reverse approach curves prior to the entry curve are adopted, accident rates then need to be calculated on each of these approach curves. This can be achieved by repeating this procedure for the revised geometry by starting at Step 2 of Calculation A.

7. Determine the traffic flow 'Q' applicable to each segment.
8. Calculate single vehicle accident rates for vehicle path segments prior to the holding line 'A<sub>sp</sub>' and after the holding line 'A<sub>sa</sub>' using Equation 14-1 and Equation 14-2 respectively. If approach curves have been used, the sum of the of the single vehicle accident rates for the approach curves and the entry curve must be less than the original value for the entry curve alone to warrant the provision of the approach curves.
9. Calculate single vehicle accident costs for vehicle path segments prior to the holding line and after the holding line. This is equal to the calculated accident rate multiplied by the average accident costs of \$74,200 and \$50,000 respectively. The decision to redesign the roundabout geometry to lower the single vehicle accident rate may be based on a calculated Benefit/Cost Ratio (BCR).

Refer to Figure 14.38 for an example of calculating single vehicle accident rates according to this procedure.

**Equation 14-1**

$$A_{sp} = \frac{1.64 \times 10^{-12} \times Q^{1.17} \times L \times (S + \Delta S)^{4.12}}{R^{1.91}}$$

**Equation 14-2**

$$A_{sa} = \frac{1.79 \times 10^{-9} \times Q^{0.91} \times L \times (S + \Delta S)^{1.93}}{R^{0.65}}$$

Where:

- A<sub>sp</sub> = number of single vehicle accidents per year per vehicle path segment prior to the holding line
- A<sub>sa</sub> = number of single vehicle accidents per year per vehicle path segment after the holding line
- Q = average annual daily traffic (AADT) in the direction considered (i.e. one way traffic only) (veh/d)
- L = length of the driver path on the horizontal geometric element (m)
- S = 85<sup>th</sup> percentile speed on the horizontal geometric element (km/h)
- ΔS = decrease in 85<sup>th</sup> percentile speed at the start of the horizontal geometric element (km/h)
- R = vehicle path radius on the horizontal geometric element (m)

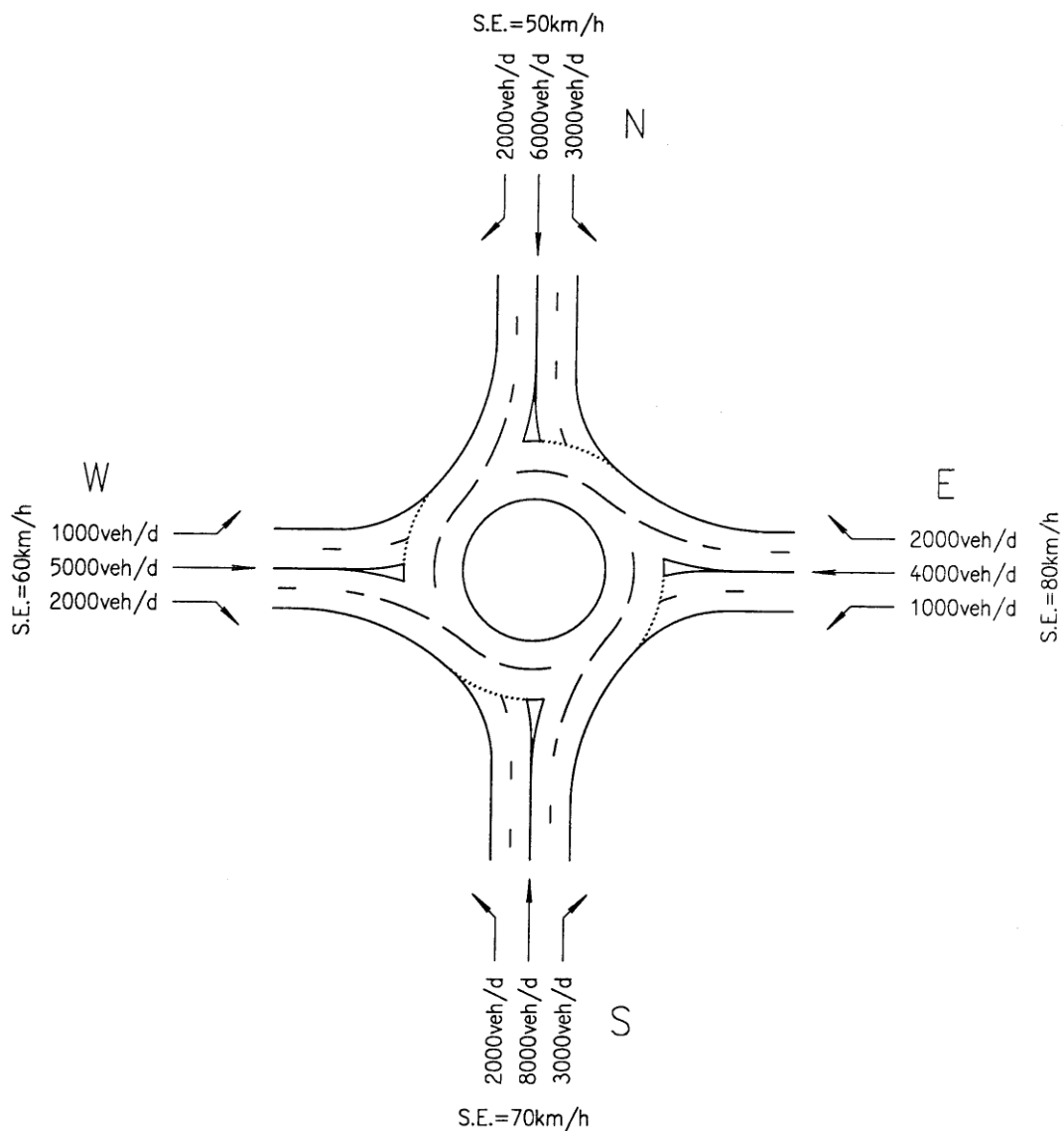

Figure 14.36 Roundabout example for the calculation of accident rates according to the procedures given in this appendix

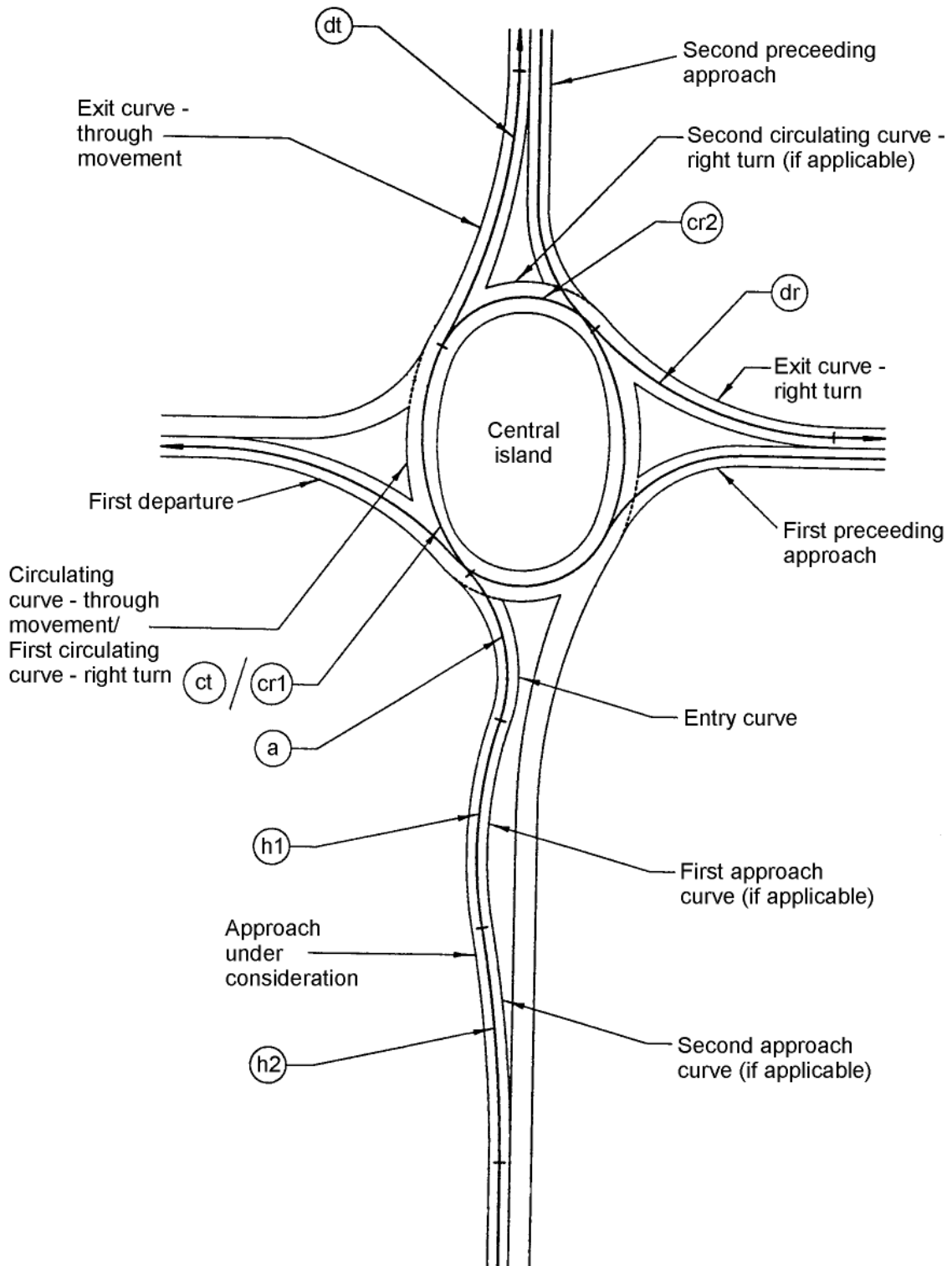
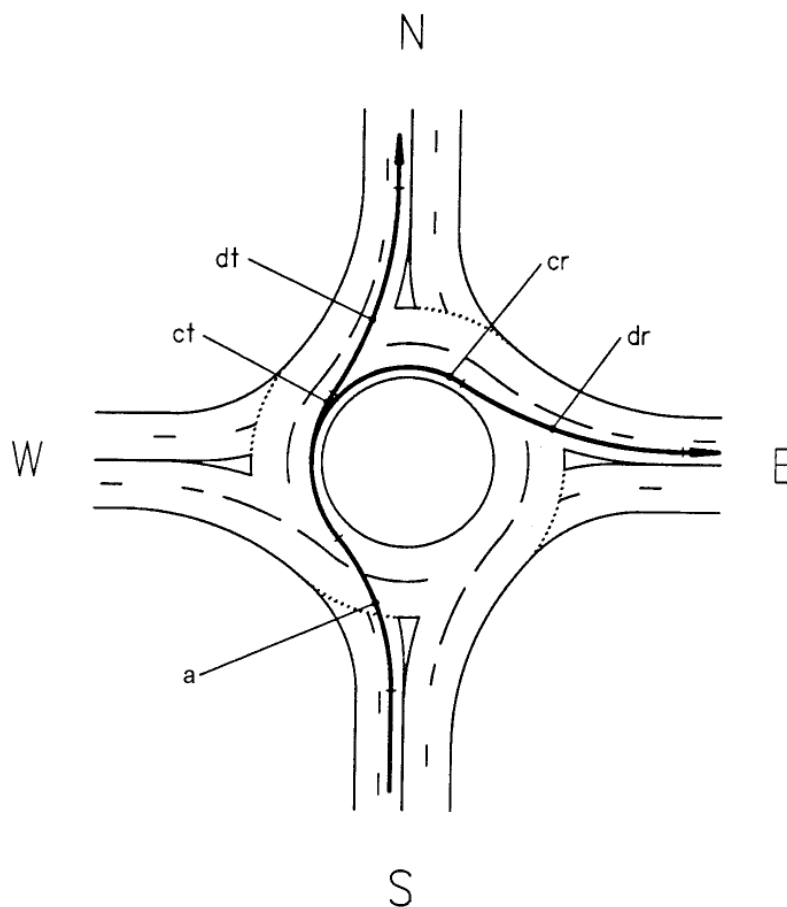

Figure 14.37 Codes for vehicle path segments



Path Label Step A2	R (m) Step A3	L (m) Step A4	S (km/h) Step A5	$\Delta S$ (km/h) Step A6	Q (veh/d) Step A7	$P_{sp}$ Step A8	$P_{sa}$ Step A8	$A_{sp}$ or $A_{sa}$ (acc/y) Step A9	Accident Cost (\$) Step A10
ap	51.7	30.8	55.8	14.2	13 000	$6.57 \times 10^5$	-	0.07	5201
ct	20.8	22.8	36.4	19.4	8 000	-	$7.45 \times 10^3$	0.047	2373
dt	82.2	40.9	36.4	0	8 000	-	$2.4 \times 10^3$	0.015	763
cr	15.3	41.8	31.2	24.5	3 000	-	$1.66 \times 10^4$	0.044	2176
dr	82.2	42.8	31.2	0	3 000	-	$1.86 \times 10^3$	0.005	243

Figure 14.38 Calculation of single vehicle accident rates for vehicles travelling from the Southern leg for the roundabout in shown Figure 14.36

Calculation B - Calculation of approaching rear-end vehicle accident rates at roundabouts

1. Identify the first circulating-through movement from the particular approach. This movement will be the one that goes from the particular approach to the first departure clockwise that gave a solution in Step 1 of Calculation A for single vehicle accidents. If this movement is to the first actual departure clockwise from the approach, adopt the second through movement.
2. Determine vehicle paths from Appendix 14B for the movement identified in Step 1 of Calculation B for vehicles remaining in the right lane. This path has been calculated in Step 2 of Calculation A for single vehicle accidents.
3. Measure the radius of the vehicle path on the entry curve and the horizontal element prior to the entry curve for the movement identified in Step 2 of Calculation B. These will be the same vehicle path radii used for calculating single vehicle accident rates.
4. Determine the 85<sup>th</sup> percentile speed on the entry curve ' $S_a$ ' and the horizontal element prior to the entry by using the speed prediction model in Appendix 14B. This will be the same value as the 85<sup>th</sup> percentile entry speed used for calculating single vehicle accident rates. The approach should be reviewed with the intent of improving the geometry if the 85<sup>th</sup> percentile speed on the entry curve exceeds 60km/h. If the

85<sup>th</sup> percentile speed on the horizontal element prior to the entry curve exceeds 80km/h, consideration should be given to the provision of a combination of the treatments listed in Section 14.8.1.

5. Determine the number of lanes on the particular approach ' $N_a$ '.
6. Calculate the total approaching traffic flow ' $Q_a$ '. This will be the same value as the total approaching traffic flow used for calculating single vehicle accident rates.
7. Identify all possible conflicting vehicle paths on the circulating carriageway adjacent the particular approach (refer Figure 14.39).
8. Calculate the total circulating traffic flow adjacent to the approach ' $\Sigma Q_{ci}$ '. This is the sum of the traffic flows for each of the conflicting vehicle paths on the circulating carriageway in Step 7 of Calculation B.
9. Calculate the approaching rear-end vehicle accident rate ' $A_r$ ' on the particular approach using Equation 14-3.
10. Calculate approaching rear-end vehicle accident costs. This is equal to the accident rate multiplied by the average cost of an approaching rear-end vehicle accident of \$14,500. The decision to redesign the roundabout approach to lower the approaching rear-end vehicle accident rate may be based on a calculated BCR.

Refer to Figure 14.40 for an example of calculating approaching rear-end vehicle accident rates according to this procedure.

**Equation 14-3**

$$A_r = 1.81 \times 10^{-18} \times Q_a^{1.39} \times \left( \sum Q_{ci} \right)^{0.65} \times S_a^{4.77} \times N_a^{2.31}$$

Where:

- $A_r$  = number of approaching rear-end vehicle accidents per year per approach
- $Q_a$  = AADT on the approach (i.e. one way traffic only) (veh/d)
- $Q_{ci}$  = the AADT on the circulating carriageway adjacent to the approach (veh/d)
- $S_a$  = 85<sup>th</sup> percentile speed on the entry curve (km/h)
- $N_a$  = the number of lanes on the particular roundabout approach

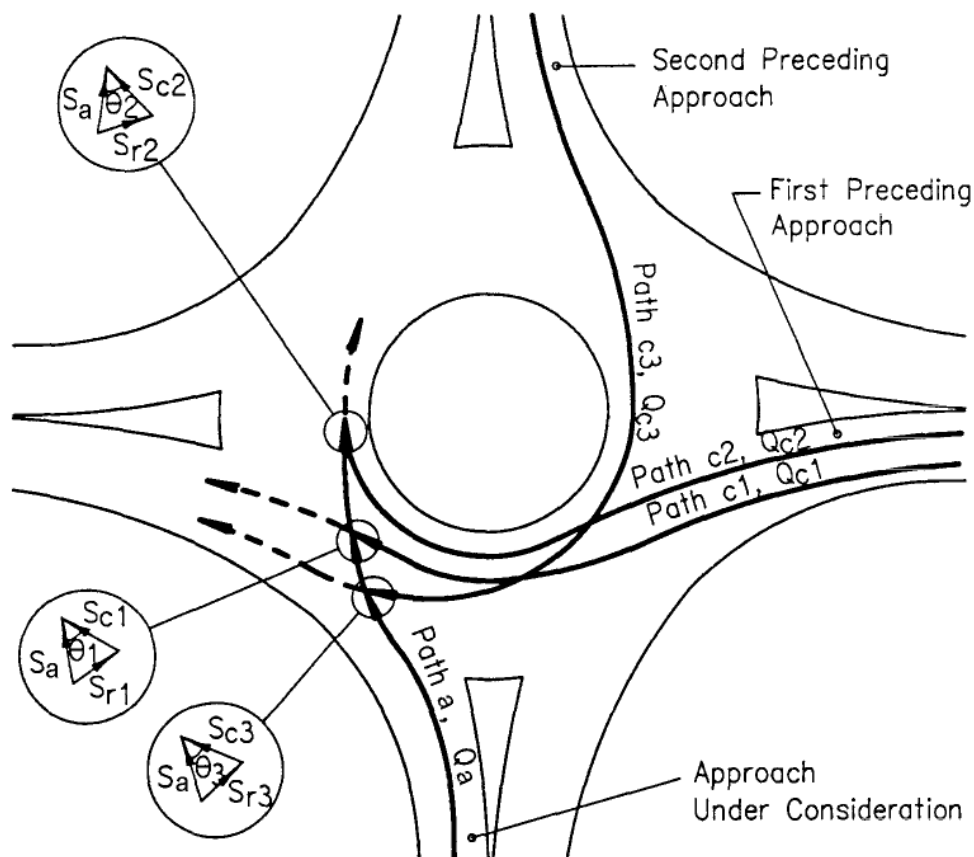

**Figure 14.39** The various traffic flows on the circulating carriageway and the various relative speeds between entering and circulating vehicles

14

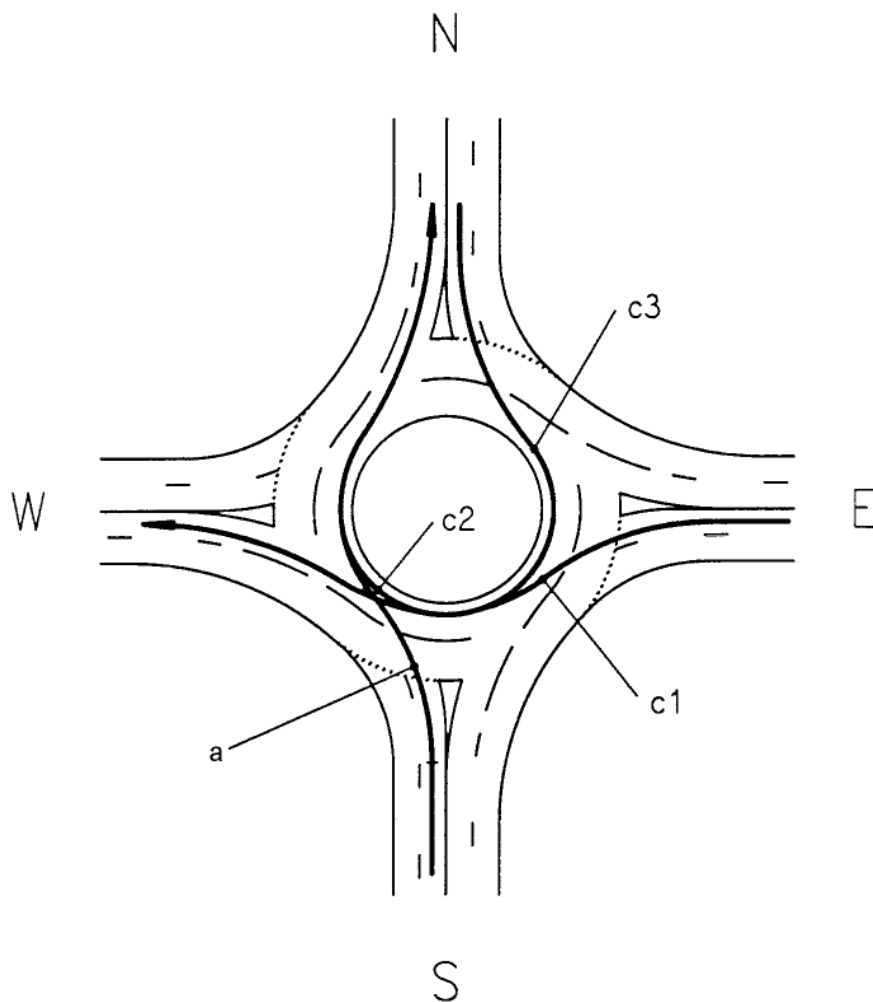

$R_a$ (m) Step B3	$S_a$ (km/h) Step B4	$N_a$ Step B5	$Q_a$ (veh/d) Step B6	$Q_c$ (veh/d) Step B8	$A_r$ (acc/y) Step B9	Accident Cost (\$) Step B10
51.7	55.8	2	13 000	8 000	0.346	5013

Figure 14.40 Calculation of approaching rear-end vehicle accident rates on the Southern leg for the roundabout shown in Figure 14.36



Calculation C - Calculation of entering/circulating vehicle accident rates at roundabouts

1. Identify the first circulating-through movement from the particular approach. This will be the same movement as that identified in Step 1 of Calculation B for approaching rear-end vehicle accidents.
2. Determine vehicle paths from Appendix 14B for vehicles remaining in the right lane for the movement in Step 1 of Calculation C. These paths have been calculated in Step 2 of Calculation B for approaching rear-end vehicle accidents.
3. Measure the radius of the vehicle path on the entry curve ' $R_a$ ' identified in Step 2 of Calculation C. This will be the same value as the vehicle path radius calculated on the entry curve for single vehicle accidents and approaching rear-end vehicle accidents.
4. Determine the 85<sup>th</sup> percentile entering speed ' $S_a$ '. This is the 85<sup>th</sup> percentile speed on the entry curve determined from the speed prediction model in Appendix 14B by assuming no acceleration between horizontal geometric elements. This will be the same value as the speed calculated on the approach curve for single vehicle and approaching rear-end vehicle accidents.
5. Calculate the total entering traffic flow ' $Q_a$ '. This will be the same value as the approach flow used for calculating single vehicle and approaching rear-end vehicle accident rates.
6. Determine the number of circulating lanes ' $N_c$ ' of the roundabout.
7. Identify all possible conflicting vehicle paths on the circulating carriageway adjacent the particular approach (refer Figure 14.39). This will be the same as those paths found for the approaching rear-end vehicle accident model.
8. Determine vehicle paths from Appendix 14B for vehicles in the right lane for all conflicting circulating movements identified in Step 7 of Calculation C. Label these movements as "c1, c2, ..." etc.
9. Determine the desired speed for each of the conflicting circulating vehicle paths determined in Step 8 of Calculation C.
10. Measure the radius of the circulating vehicle path ' $R_{ci}$ ' for each of the vehicle paths determined in Step 8 of Calculation C.
11. Determine the 85<sup>th</sup> percentile speeds on the circulating carriageway ' $S_{ci}$ ' for each of the vehicle paths determined in Step 8 of Calculation C. This will be the 85<sup>th</sup> percentile speed on the circulating carriageway determined from the speed prediction model in Appendix 14B by assuming no acceleration between each segment.
12. Determine the angles at which the entering vehicle path found in Step 2 of Calculation C crosses each conflicting circulating path identified in Step 8 of Calculation C.
13. Determine the relative speeds between entering and circulating vehicles ' $S_{ri}$ ' using the 85<sup>th</sup> percentile speeds calculated in Steps 4 and 11 of Calculation C and the angles in calculated in Step 12 of Calculation C by applying the cosine rule. The geometry of the roundabout should be reviewed with the intent of improving

the geometry if any of the values of the relative speeds between entering and circulating vehicles exceed 50km/h.

14. Calculate each circulating traffic flow adjacent the approach 'Q<sub>ci</sub>' for each of the conflicting vehicle paths on the circulating carriageway identified in Step 8 of Calculation C.
15. Measure the distance from the holding line of each preceding approach to the intersection point between entering and circulating vehicles 'd<sub>Gi</sub>' according to Figure 14.41.
16. Calculate the various travel times taken from the holding line of the particular preceding approach to the intersection point between entering and circulating vehicles 't<sub>Gi</sub>' using Figure 14.41.
17. Calculate the value of the entering/circulating vehicle accident parameter combination 'P<sub>e</sub>' using Equation 14-4 for each of the conflicting vehicle paths on the circulating carriageway identified in Step 8 of Calculation C. The geometry of the roundabout should be reviewed with the intent of improving the geometry if any of the values of the

entering/circulating vehicle accident parameter combination exceed 300.

18. Calculate the average relative 85<sup>th</sup> percentile speed between vehicles on the entry curve and vehicles on the circulating carriageway 'S<sub>ra</sub>' using Equation 14-5.
19. Calculate the average travel time taken from the holding line of the particular preceding approach to the intersection point between entering and circulating vehicles 't<sub>Ga</sub>' using Equation 14-6.
20. Calculate the entering/circulating vehicle accident rate 'A<sub>e</sub>' on the particular approach using Equation 14-7.
21. Calculate entering/circulating vehicle accident costs. This is equal to the accident rate multiplied by the average cost of an entering/circulating vehicle accident of \$26,700. The decision to redesign the roundabout approach or a preceding approach to lower the entering/circulating vehicle accident rate may be based on a calculated BCR.

Refer to Figure 14.42 for an example of calculating entering/circulating vehicle accident rates according to this procedure.

**Equation 14-4**

$$P_e = \frac{N_c^{0.9} \times S_{ri}^{1.38}}{t_{Gi}^{0.21}}$$

**Equation 14-5**

$$S_{ra} = \frac{Q_{ci} \times S_{ri}}{\sum Q_{ci}}$$

**Equation 14-6**

$$t_{Ga} = \frac{Q_{ci} \times t_{Gi}}{\sum Q_{ci}}$$

Equation 14-7

$$A_e = \frac{7.31 \times 10^{-7} \times Q_a^{0.47} \times N_c^{0.9} \times (\sum Q_{ci})^{0.41} \times S_{ra}^{1.38}}{t_{Ga}^{0.21}}$$

Where:

- $P_e$  = Entering/circulating vehicle accident parameter combination
- $S_{ra}$  = the average relative 85<sup>th</sup> percentile speed between vehicles on the entry curve and vehicles on the circulating carriageway from each direction (km/h)
- $t_{Ga}$  = the average travel time taken from the holding lines of preceding approaches to the intersection point between the entering and circulating vehicles (s)
- $A_e$  = number of entering/circulating vehicle accidents per year per approach
- $N_c$  = the number of circulating lanes of the roundabout
- $S_{ri}$  = the various relative 85<sup>th</sup> percentile speeds between vehicles on the entry curve and vehicles on the circulating carriageway from each direction according to Figure 14.39 (km/h)
- $t_{Gi}$  = the various travel times taken from the holding line of the particular preceding approach to the intersection point between the entering and circulating vehicles according to Figure 14.41 (s)
- $Q_{ci}$  = the various average annual daily traffic flows on the circulating carriageway adjacent the approach from each direction according to Figure 14.39 (veh/d)
- $Q_a$  = AADT on the approach (i.e. one way traffic only) (veh/d)

Calculation D - Calculation of exiting/circulating vehicle accident rates at roundabouts

1. Determine the number of circulating lanes of the roundabout ' $N_c$ '. If the roundabout has only one circulating lane, exiting/circulating vehicle accidents are not calculated. For multi-lane roundabouts, calculate exiting/circulating vehicle accidents according to the following steps.
2. Identify the first approach anti-clockwise from the particular departure that forms the first circulating-through movement to this departure. This movement will be from the particular approach leg for which a solution can be obtained by using the vehicle path criteria in Appendix 14B. This criteria is for vehicles that remain in the right lane. From this approach, determine the circulating-right movement.
3. Determine vehicle paths from Appendix 14B for vehicles in the outer circulating lane for the circulating-right movement identified in Step 2 of Calculation D. Label this movement as 'cr'.
4. Measure the radius of the vehicle path on the circulating carriageway ' $R_{cr}$ ' identified in Step 3 of Calculation D.

14

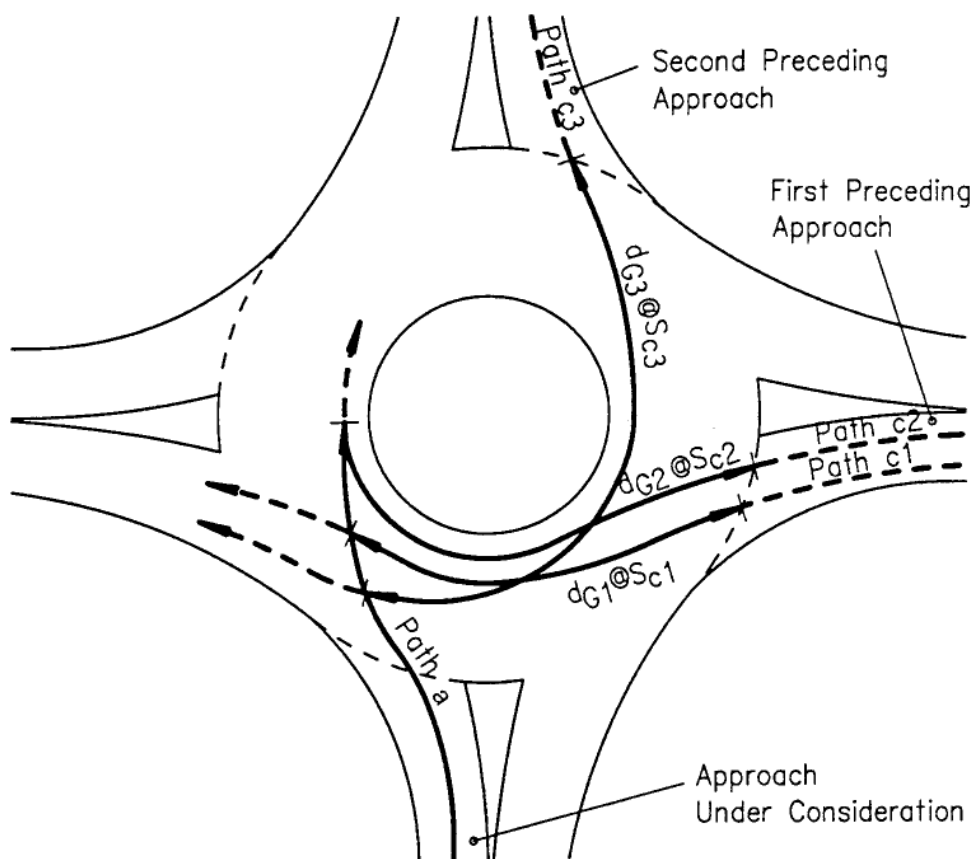

$$t_{Gi} = 3.6 \times d_{Gi} / S_{ci}$$

- where
- $t_{Gi}$  = the various travel times taken from the give way line of the particular preceding approach to the intersection point between the entering and circulating vehicles (secs)
  - $d_{Gi}$  = distance from the give way line of the particular preceding approach to the intersection point between entering and circulating vehicles as shown (m)
  - $S_{ci}$  = the various 85th percentile speeds on the circulating carriageway adjacent the approach for each direction (km/h)

**Figure 14.41** The various travel times taken from the holding line of the particular preceding approach to the intersection point between entering and circulating vehicles

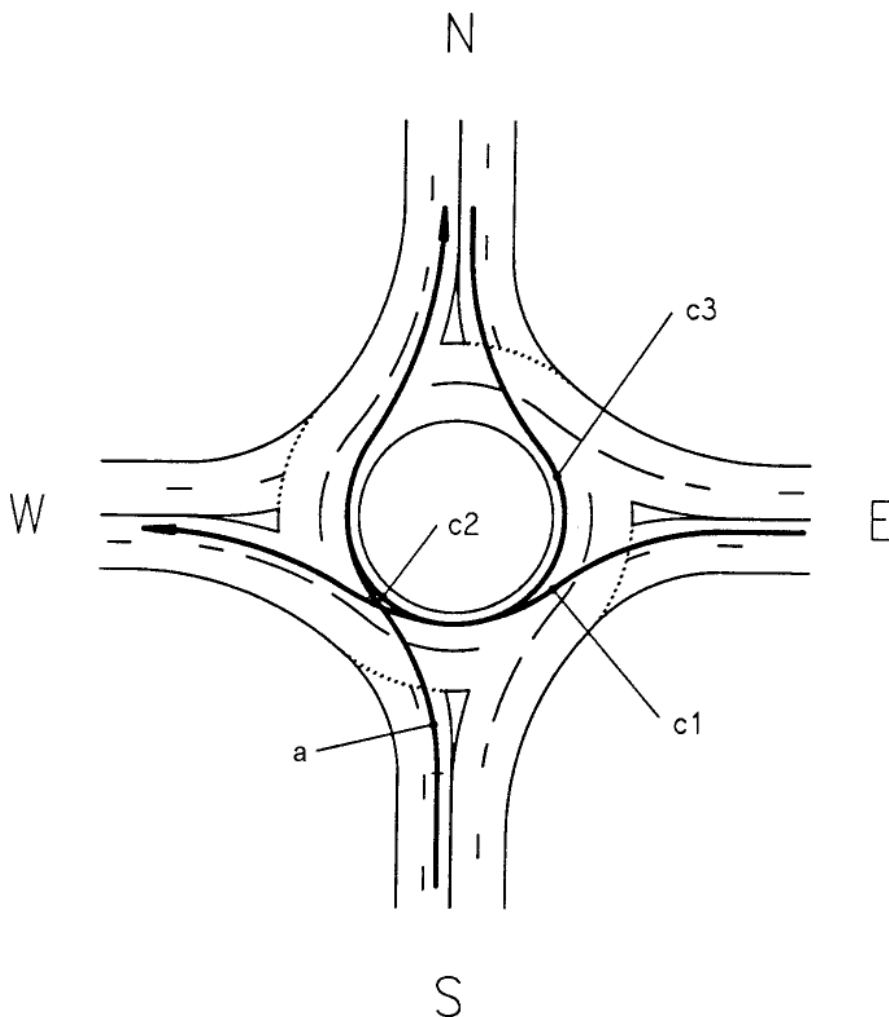

Step C3 -  $R_a = 51.7\text{m}$   
 Step C4 -  $S_a = 55.8\text{ km/h}$   
 Step C5 -  $Q_a = 13\ 000\text{ veh/d}$   
 Step C6 -  $N_c = 2$

Path Label	SE (km/h)	$R_{ci}$ (m)	$S_{ci}$ (km/h)	An (deg)	$S_{ri}$ (km/h)	$Q_{ci}$ (veh/d)	$d_{Gi}$ (m)	$t_{Gi}$ (secs)	$P_c$
Step C8	Step C9	Step C10	Step C11	Step C12	Step C13	Step C14	Step C15	Step C16	Step C17
c1	80	20.8	36.4	27.5	28.9	4 000	35.2	3.48	149
c2	80	15.3	31.2	7.5	25.2	2 000	42.3	4.88	115
c3	50	15.3	31.2	27.5	31.6	2 000	57.8	6.67	147

Step C18 -  $S_{ra} = 28.6\text{ km/h}$   
 Step C19 -  $t_{Ga} = 4.63\text{ secs}$   
 Step C20 -  $A_c = 0.346\text{ acc/y}$   
 Step C21 - Acc. Cost = \$9246

Figure 14.42 Calculation of entering/circulating vehicle accident rates on the Southern leg for the roundabout shown in Figure 14.36

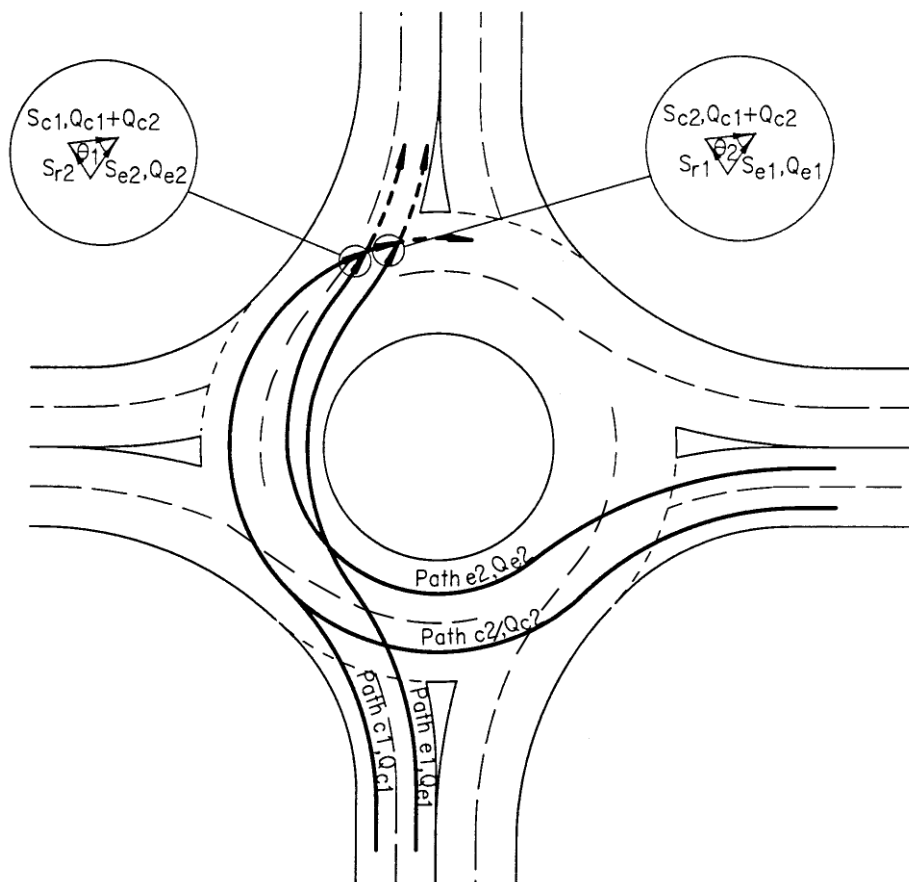

Note - Traffic from approach leg 4 is not included into the  $Q_{ci}$  term because this traffic would form an entering/circulating type accident with the traffic in the  $Q_{ei}$  term because of failing to give way.

**Figure 14.43 The various circulating and exiting traffic flows and various relative speeds between exiting and circulating vehicles**

5. Determine the 85<sup>th</sup> percentile speed of the circulating vehicle path ‘ $S_{cr}$ ’ identified in Step 3 of Calculation D. This is the 85<sup>th</sup> percentile speed on the circulating carriageway determined from the speed prediction model in Appendix 14B by assuming no acceleration between horizontal geometric elements.
6. Calculate the total circulating-right traffic flow ‘ $Q_{ci}$ ’. This will be the total circulating traffic flow continuing to circulate past the exit point of the particular departure minus any traffic flow which has just entered onto the roundabout.
7. Identify all possible conflicting exiting vehicle paths (refer Figure 14.43).
8. Determine vehicle paths from Appendix 14B for vehicles on the inner circulating lane for all movements identified in Step 7 of Calculation D. Label these movements as “e1, e2, ...” etc.

9. Determine the desired speed for each of the conflicting exiting vehicle paths determined in Step 8 of Calculation D.
10. Measure the radius of the circulating vehicle path 'R<sub>ei</sub>' for each of the exiting vehicle paths determined in Step 8 of Calculation D.
11. Determine the 85<sup>th</sup> percentile exiting speeds 'S<sub>ei</sub>' for each of the vehicle paths determined in Step 8 of Calculation D. This will be the 85<sup>th</sup> percentile speed on the circulating carriageway determined from the speed prediction model in Appendix 14B by assuming no acceleration between each segment.
12. Determine the angles at which the circulating-right vehicle path found in Step 2 of Calculation D crosses each conflicting circulating path identified in Step 8 of Calculation D.
13. Determine the relative speeds between exiting and circulating vehicles 'S<sub>ri</sub>' using the 85<sup>th</sup> percentile speeds calculated in Steps 5 and 11 of Calculation D and the angle in Step 12 of Calculation D by applying the cosine rule. The roundabout geometry should be reviewed if any of the relative speeds between exiting and circulating vehicles exceed 35km/h.
14. Calculate each exiting traffic flow 'Q<sub>ei</sub>' for each of the conflicting exiting vehicle paths on the circulating carriageway identified in Step 8 of Calculation D.
15. Calculate the average relative 85<sup>th</sup> percentile speed between exiting and

circulating vehicles 'S<sub>ra</sub>' using Equation 14-8.

16. Calculate exiting/circulating vehicle accident rates on the particular leg using Equation 14-9.
17. Calculate exiting/circulating vehicle accident costs. This is equal to the accident rate multiplied by the average cost of an exiting/circulating vehicle accident of \$27,100. The decision to redesign the roundabout to lower the exiting/circulating vehicle accident rate may be based on a calculated BCR.

Refer to Figure 14.44 for an example of calculating exiting/circulating vehicle accident rates according to this procedure.

**Equation 14-8**

$$S_{ra} = \frac{\sum(Q_{ei} \times S_{ri})}{\sum Q_{ei}}$$

Where

- S<sub>ra</sub> = the average relative 85<sup>th</sup> percentile speed between vehicles exiting the roundabout and vehicles continuing to circulate around the roundabout at the particular departure leg according to Figure 14.43 and Equation 14-9 (km/h)
- Q<sub>ei</sub> = the various AADTs exiting the roundabout at the exit point of a departure leg according to Figure 14.43 (veh/d)
- S<sub>ri</sub> = the various relative 85<sup>th</sup> percentile speeds between vehicles exiting the roundabout and vehicles continuing to circulate around the roundabout at the particular departure leg according to Figure 14.43 (km/h)

14

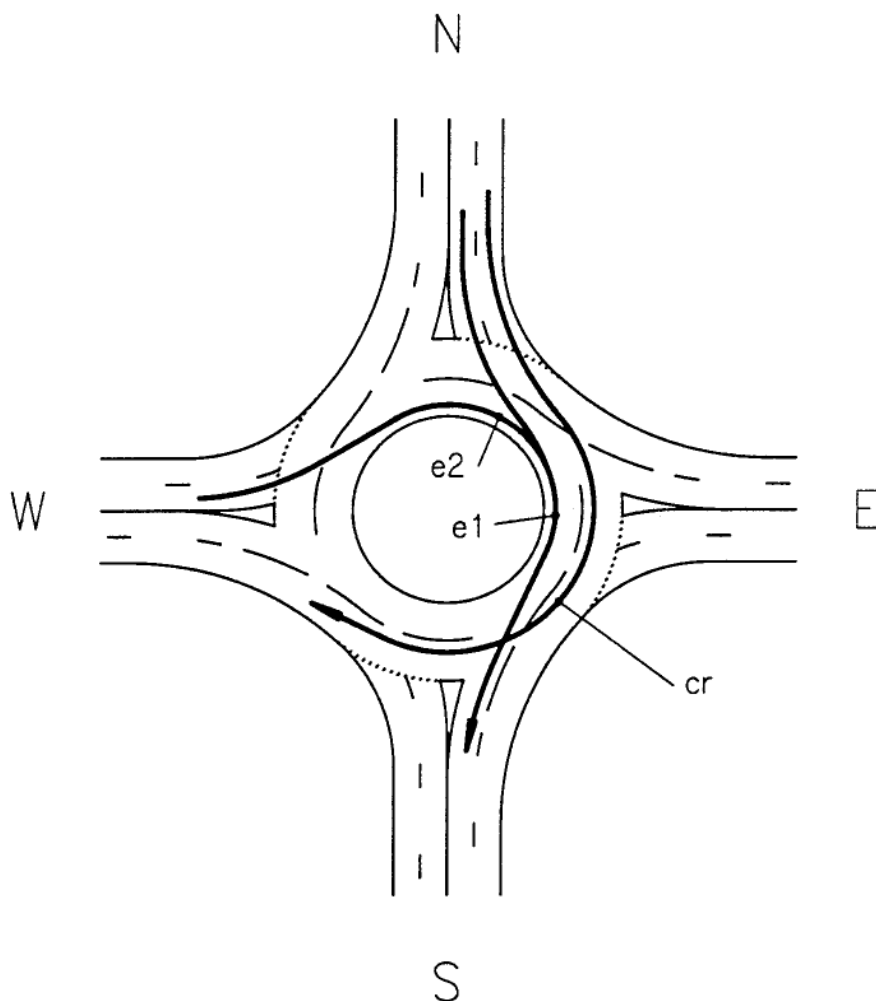

- Step D1 -  $N_c = 2$
- Step D4 -  $R_{cr} = 20.4\text{m}$
- Step D5 -  $S_{cr} = 36.0\text{ km/h}$
- Step D6 -  $Q_{ei} = 2\,000\text{ veh/d}$

Path Label	SE (km/h)	$R_{ei}$ (m)	$S_{ei}$ (km/h)	An (degrees)	$S_{ri}$ (km/h)	$Q_{ei}$ (veh/d)
Step D8	Step D9	Step D10	Step D11	Step D12	Step D13	Step D14
e1	50	20.8	36.4	38.4	23.8	6 000
e2	60	15.3	31.2	38.4	22.6	2 000

- Step D15 -  $S_{ra} = 23.5\text{ km/h}$
- Step D16 -  $A_d = 0.031\text{ acc/y}$
- Step D17 - Acc. Cost = \$850

Figure 14.44 Calculation of exiting/circulating vehicle accident rates on the Southern leg for the roundabout shown in Figure 14.36



### Equation 14-9

$$A_d = 1.33 \times 10^{-11} \times \left( \sum Q_{ci} \right)^{0.32} \times \left( \sum Q_{ei} \right)^{0.68} \times S_{ra}^{4.13}$$

Where:

- $A_d$  = number of exiting/circulating vehicle accidents per year per departure
- $Q_{ci}$  = the various AADTs at the exit point of a departure that are continuing to circulate around the roundabout according to Figure 14.43 (veh/d)
- $Q_{ei}$  = the various AADTs exiting the roundabout at the exit point of a departure leg according to Figure 14.43 (veh/d)
- $S_{ra}$  = the average relative 85<sup>th</sup> percentile speed between vehicles exiting the roundabout and vehicles continuing to circulate around the roundabout at the particular departure according to Figure 14.43 and Equation 14-9 (km/h)

#### Calculation E - Calculation of sideswipe vehicle accident rates at roundabouts

1. Identify all possible movements from the particular approach leg ignoring left turns. This will be the same movements as those identified for single vehicle accidents in Step 1 of Calculation A.
2. Determine all of the geometric elements along each of the movements identified in Step 1 of Calculation E that comprise one lane. Sideswipe vehicle accidents are not calculated for vehicle path segments on single lane geometric elements. For all multi-lane geometric elements, calculate sideswipe vehicle accidents according to the following steps.
3. Determine vehicle paths from Appendix 14B for vehicles in the right lane and for vehicles cutting lanes.

Label each segment of the vehicle path according to the coding system in Figure 14.37.

4. Measure the radius of each segment of each vehicle path 'R and  $R_c$ ' as identified in Step 3 of Calculation E.
5. Determine the 85<sup>th</sup> percentile speed on each segment of the cutting vehicle paths ' $S_c$ ' from the speed prediction model in Appendix 14B by assuming no acceleration between each segment.
6. Calculate the decrease in 85<sup>th</sup> percentile speed at the start of each horizontal geometric element for vehicles cutting lanes ' $\Delta S_c$ '.
7. Determine the difference in potential side friction for each segment of all vehicle paths ' $\Delta f_1$ ' using Equation 14-10. The geometry of any segment of the roundabout should be reviewed if the difference in potential side friction exceeds 0.7.
8. Determine the traffic flow applicable for each movement for each segment of vehicle path 'Q'. This will be the same traffic flows as those used to calculate single vehicle accidents.
9. Determine the total traffic flow applicable on the particular horizontal geometric element ' $Q_t$ ' according to Table 14.10.
10. Calculate sideswipe vehicle accident rates on each vehicle path segment using Equation 14-11.
11. Calculate sideswipe vehicle accident costs. This is equal to the accident rate multiplied by the average cost of a sideswipe vehicle accident of \$23,800.

The decision to redesign the roundabout geometry to lower the sideswipe vehicle accident rate may be based on a calculated BCR.

Refer to Figure 14.46 for an example of calculating sideswipe vehicle accident rates according to this procedure.

- R = radius of the vehicle path for vehicles not cutting lanes (m)
- R<sub>c</sub> = radius of the vehicle path for vehicles cutting lanes (m)

**Equation 14-11**

$$A_{ss} = 6.49 \times 10^{-8} \times (Q \times Q_t)^{0.72} \times \Delta f_1^{0.59}$$

Where:

- A<sub>ss</sub> = number of sideswipe vehicle accidents per year per vehicle path segment
- Q = the AADT for the particular movement on the particular geometric element according to Table 14.10 (veh/d)
- Q<sub>t</sub> = the total AADT on the particular geometric element according to Table 14.10 (veh/d)
- Δf<sub>1</sub> = difference in potential side friction according to Equation 14-10 ((km/h)<sup>2</sup>/m)

**14**

**Equation 14-10**

$$\Delta f_1 = \left| \frac{(S_c + \Delta S_c)^2}{(127 \times R)} - \frac{(S_c + \Delta S_c)^2}{(127 \times R_c)} \right|$$

Where:

- Δf<sub>1</sub> = difference in potential side friction ((km/h)<sup>2</sup>/m)
- S<sub>c</sub> = 85<sup>th</sup> percentile speed on the horizontal geometric element for the particular movement for vehicles cutting lanes (km/h)
- ΔS<sub>c</sub> = decrease in 85<sup>th</sup> percentile speed at the start of the horizontal geometric element for vehicles cutting lanes (km/h)

**Table 14.10 Sideswipe traffic flows**

Movement	Symbol (refer Figure 14.37)	Parameter	Applicable traffic flow	Example calculation (refer Figure 14.45)
Approaching	h <sub>1</sub> , h <sub>2</sub>	Q	Total approaching traffic flow	Q <sub>IL</sub> +Q <sub>IT</sub> +Q <sub>IR</sub>
		Q <sub>t</sub>	Total approaching traffic flow	Q <sub>IL</sub> +Q <sub>IT</sub> +Q <sub>IR</sub>
Entering	a	Q	Total approaching traffic flow	Q <sub>IL</sub> +Q <sub>IT</sub> +Q <sub>IR</sub>
		Q <sub>t</sub>	Total approaching traffic flow	Q <sub>IL</sub> +Q <sub>IT</sub> +Q <sub>IR</sub>
Circulating-through	ct	Q	Circulating-through traffic flow	Q <sub>IT</sub>
		Q <sub>t</sub>	Total circulating traffic flow	Q <sub>IT</sub> +Q <sub>IR</sub> +Q <sub>IR</sub>
Circulating-right	cr	Q	Circulating-right traffic flow	Q <sub>IR</sub>
		Q <sub>t</sub>	Total circulating traffic flow	Q <sub>IT</sub> +Q <sub>IR</sub> +Q <sub>2T</sub> +Q <sub>2R</sub> +Q <sub>4R</sub>
Exiting-through	dt	Q	Exiting-through traffic flow	Q <sub>IT</sub>
		Q <sub>t</sub>	Total departing traffic flow	Q <sub>IT</sub> +Q <sub>2L</sub> +Q <sub>4R</sub>
Exiting-right	dr	Q	Exiting-right traffic flow	Q <sub>IR</sub>
		Q <sub>t</sub>	Total departing traffic flow	Q <sub>IR</sub> +Q <sub>2T</sub> +Q <sub>3L</sub>

Calculation F - Calculation of 'Other'  
Accident Rates at Roundabouts

1. Calculate the total approaching traffic flow 'Q<sub>a</sub>'. This will be the same value as the total approaching traffic flow used for calculating single vehicle accident rates. For the southern leg of the roundabout in Figure 14.36, this value is 13,000 veh/d.
2. Calculate the rate of the "other" accidents on the particular approach 'A<sub>1</sub>' using Equation 14-12. For the southern leg of the roundabout in Figure 14.36, this value calculates to be 0.056 acc/y.

3. Calculate costs of the "other" accidents. This is equal to the accident rate multiplied by the average cost of a low frequency accident of \$45,000. For the roundabout in Figure 14.36, this value calculates to be \$2,520/y.

**Equation 14-12**

$$A_1 = 4.29 \times 10^{-6} \times Q_a$$

Where:

- A<sub>1</sub> = number of "other" accidents per year per leg
- Q<sub>a</sub> = AADT on the approach (i.e. one way traffic only) (veh/d)

14

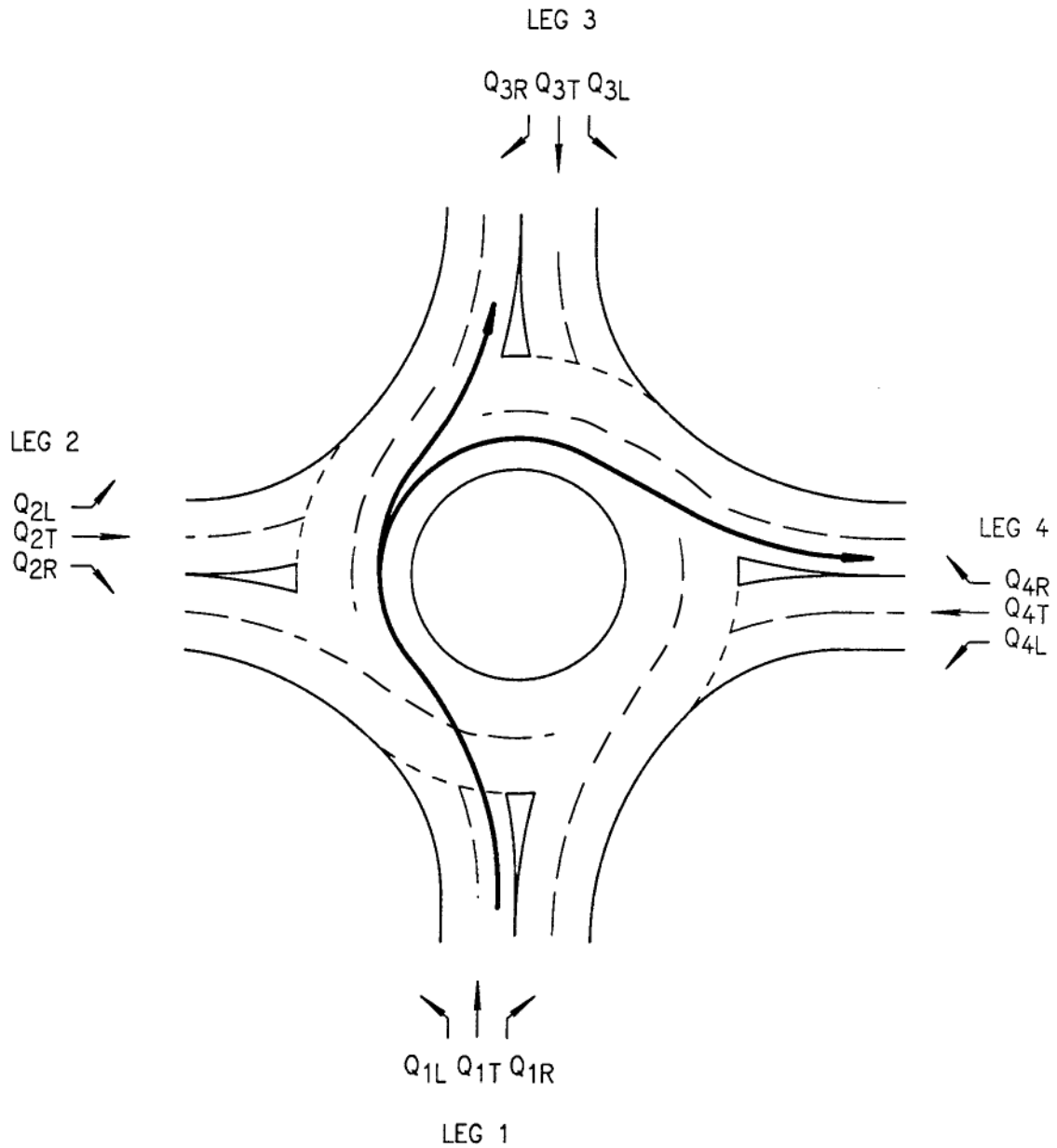
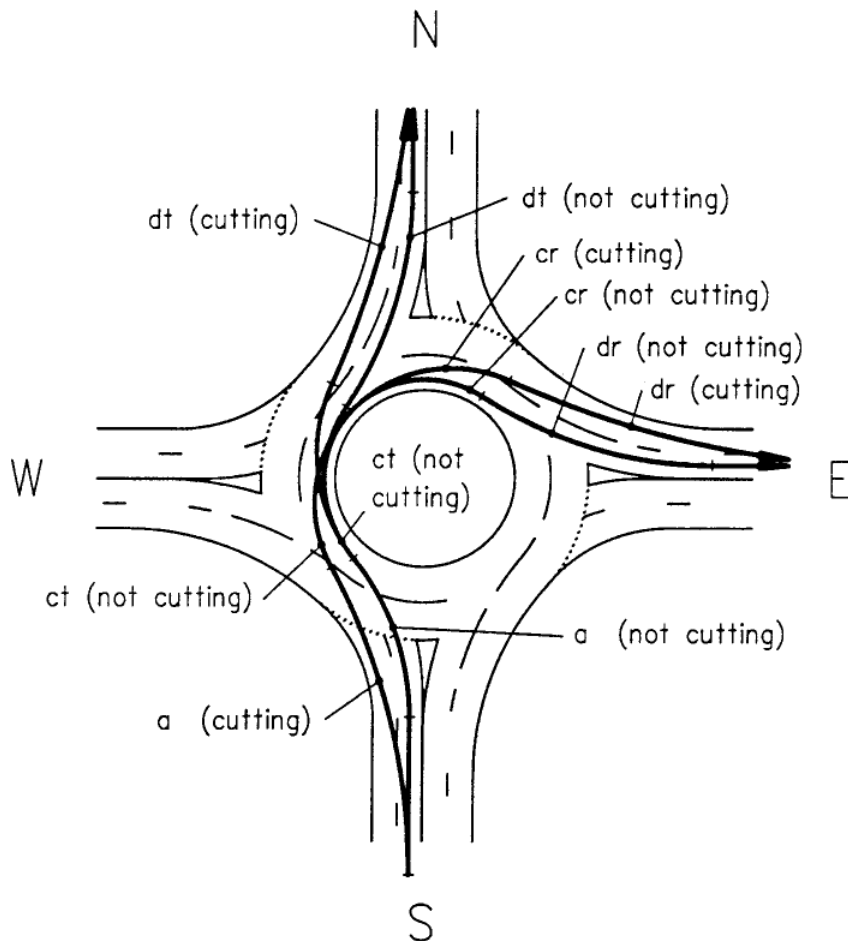

Figure 14.45 Example for the use of calculating traffic flows for the sideswipe vehicle accidents



Path Label Step E3	R (m) Step E4	R <sub>c</sub> (m) Step E4	S <sub>c</sub> (km/h) Step E5	ΔS <sub>c</sub> (km/h) Step E6	Q (veh/d) Step E7	Q <sub>t</sub> (veh/d) Step E8	Δf <sub>i</sub> ((km/h) <sup>2</sup> /m) Step E9	A <sub>ss</sub> (acc/y) Step E10	Accident Cost (\$) Step E11
a	51.7	91.4	61.6	8.4	13000	13000	0.324	0.028	667
ct	20.8	51.4	55.7	5.9	8000	13000	0.854	0.035	833
dt	82.2	139.2	55.7	0	8000	11000	0.122	0.01	234
cr	15.3	19.2	34.9	26.6	3000	20000	0.396	0.015	352
dr	82.2	139.2	34.9	0	3000	11000	0.048	0.003	67

Figure 14.46 Calculation of sideswipe vehicle accident rates for vehicles travelling from the Southern leg for the roundabout shown in Figure 14.36